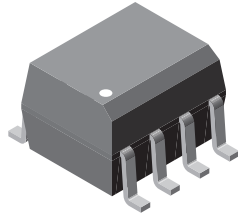
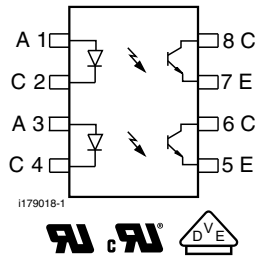


# Optocoupler, Phototransistor Output, Dual Channel, SOIC-8 Package, 100 °C Rated



i179074



## FEATURES

- Two channel coupler
- SOIC-8 surface mountable package
- Standard lead spacing of 0.05"
- Available only on tape and reel option (conforms to EIA standard 481-2)
- Isolation test voltage, 4000 V<sub>RMS</sub>
- Compatible with dual wave, vapor phase and IR reflow soldering
- Operating temperature from - 55 °C to + 110 °C
- Lead (Pb)-free component
- Material categorization: for definitions of compliance please see [www.vishay.com/doc?99912](http://www.vishay.com/doc?99912)



RoHS COMPLIANT

## LINKS TO ADDITIONAL RESOURCES



## DESCRIPTION

The 100 % rated ILD1206T and ILD1207T are optically coupled pairs with a Gallium Arsenide infrared LED and a silicon NPN phototransistor. Signal information, including a DC level, can be transmitted by the device while maintaining a high degree of electrical isolation between input and output.

The ILD1206T and ILD1207T come in a standard SOIC-8 small outline package for surface mounting which makes it ideally suited for high density applications with limited space. In addition to eliminating through-holes requirements, this package conforms to standards for surface mounted devices.

A specified minimum and maximum CTR allows a narrow tolerance in the electrical design of the adjacent circuits. The high BV<sub>CEO</sub> of 70 V gives a higher safety margin compared to the industry standard of 30 V.

## APPLICATIONS

- AC adapters
- PLCs
- Switch mode power supplies
- DC/DC converters
- Microprocessor I/O interfaces
- General impedance matching circuits

## AGENCY APPROVALS

- [UL / cUL](#) 1577
- [DIN EN 60747-5-5 \(VDE 0884\)](#), available with option 1

ORDERING INFORMATION		
<div style="display: flex; justify-content: space-around; align-items: center;"> <div style="border: 1px solid black; padding: 2px 5px;">I</div> <div style="border: 1px solid black; padding: 2px 5px;">L</div> <div style="border: 1px solid black; padding: 2px 5px;">D</div> <div style="border: 1px solid black; padding: 2px 5px;">1</div> <div style="border: 1px solid black; padding: 2px 5px;">2</div> <div style="border: 1px solid black; padding: 2px 5px;">0</div> <div style="border: 1px solid black; padding: 2px 5px;">#</div> <div style="border: 1px solid black; padding: 2px 5px;">T</div> </div> <p style="text-align: center;">PART NUMBER</p>		
AGENCY CERTIFIED / PACKAGE	CTR (%)	
	10 mA	
UL, cUL, VDE	63 to 125	100 to 200
SOIC-8	ILD1206T	ILD1207T

### Note

- For additional information on the available options refer to option information



<b>ABSOLUTE MAXIMUM RATINGS</b> ( $T_{amb} = 25\text{ }^{\circ}\text{C}$ , unless otherwise specified)				
PARAMETER	TEST CONDITION	SYMBOL	VALUE	UNIT
<b>INPUT</b>				
Peak reverse voltage		$V_R$	6	V
Peak pulsed voltage	1 $\mu\text{s}$ , 300 pps		1	A
Continuous forward current per channel			30	mA
Power dissipation		$P_{diss}$	50	mW
Derate linearly from 25 $^{\circ}\text{C}$			0.5	mW/ $^{\circ}\text{C}$
<b>OUTPUT</b>				
Collector emitter breakdown voltage		$BV_{CEO}$	70	V
Emitter collector breakdown voltage		$BV_{ECO}$	7	V
Power dissipation per channel		$P_{diss}$	125	mW
Derate linearly from 25 $^{\circ}\text{C}$			1.25	mW/ $^{\circ}\text{C}$
<b>COUPLER</b>				
Isolation test voltage	t = 1 min	$V_{ISO}$	3333	$V_{RMS}$
Total package dissipation ambient (2 LEDs and 2 detectors, 2 channels)		$P_{tot}$	300	mW
Derate linearly from 25 $^{\circ}\text{C}$			4	mW/ $^{\circ}\text{C}$
Storage temperature		$T_{stg}$	-55 to +150	$^{\circ}\text{C}$
Operating temperature		$T_{amb}$	-55 to +110	$^{\circ}\text{C}$
Soldering time from 260 $^{\circ}\text{C}$		$T_{sld}$	10	s

**Note**

- Stresses in excess of the absolute maximum ratings can cause permanent damage to the device. Functional operation of the device is not implied at these or any other conditions in excess of those given in the operational sections of this document. Exposure to absolute maximum rating for extended periods of the time can adversely affect reliability

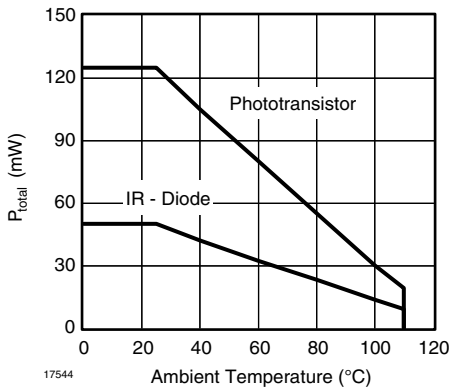


Fig. 1 - Power Dissipation vs. Ambient Temperature

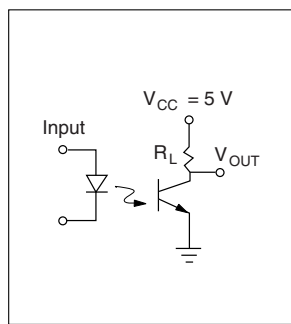
<b>ELECTRICAL CHARACTERISTICS</b> ( $T_{amb} = 25\text{ }^{\circ}\text{C}$ , unless otherwise specified)							
PARAMETER	TEST CONDITION	PART	SYMBOL	MIN.	TYP.	MAX.	UNIT
<b>INPUT</b>							
Forward voltage	$I_F = 10\text{ mA}$		$V_F$	-	1.2	1.55	V
Reverse current	$V_R = 6\text{ V}$		$I_R$	-	0.1	100	$\mu\text{A}$
Capacitance	$V_R = 0\text{ V}$		$C_O$	-	25	-	pF
<b>OUTPUT</b>							
Collector emitter breakdown voltage	$I_C = 10\text{ }\mu\text{A}$		$BV_{CEO}$	70	-	-	V
Emitter collector breakdown voltage	$I_E = 10\text{ }\mu\text{A}$		$BV_{ECO}$	7	-	-	V
Collector emitter leakage current	$V_{CE} = 10\text{ V}, I_F = 0\text{ A}$		$I_{CEO}$	-	5	50	nA
Collector emitter capacitance	$V_{CE} = 0\text{ V}$		$C_{CE}$	-	10	-	pF
Collector emitter saturation voltage	$I_F = 10\text{ mA}, I_C = 2.5\text{ mA}$		$V_{CEsat}$	-	-	0.4	V
<b>COUPLER</b>							
Capacitance (input to output)			$C_{IO}$	-	0.5	-	pF
Resistance (input to output)			$R_{IO}$	-	100	-	G $\Omega$

**Note**

- Minimum and maximum values were tested requirements. Typical values are characteristics of the device and are the result of engineering evaluations. Typical values are for information only and are not part of the testing requirements

<b>CURRENT TRANSFER RATIO</b>							
PARAMETER	TEST CONDITION	PART	SYMBOL	MIN.	TYP.	MAX.	UNIT
$I_C/I_F$	$V_{CE} = 5\text{ V}, I_F = 10\text{ mA}$	ILD1206T	$CTR_{DC}$	63	-	125	%
		ILD1207T	$CTR_{DC}$	100	-	200	%

<b>SWITCHING CHARACTERISTICS</b>							
PARAMETER	TEST CONDITION	SYMBOL	MIN.	TYP.	MAX.	UNIT	
Turn-on time	$I_C = 2\text{ mA}, R_L = 100\text{ }\Omega, V_{CC} = 5\text{ V}$	$t_{on}$	5	-	-	$\mu\text{s}$	
Turn-off time	$I_C = 2\text{ mA}, R_L = 100\text{ }\Omega, V_{CC} = 5\text{ V}$	$t_{off}$	4	-	-	$\mu\text{s}$	



iild205t\_08

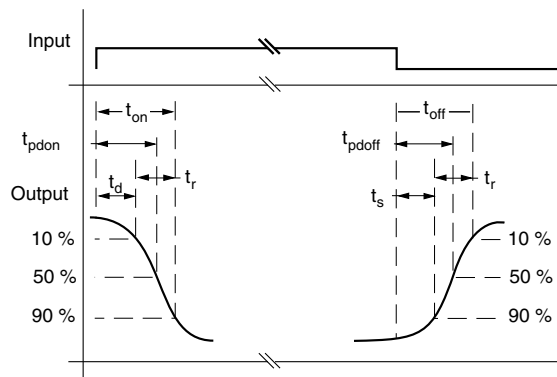


Fig. 2 - Switching Test Circuit

<b>SAFETY AND INSULATION RATINGS</b> ( $T_{amb} = 25\text{ }^{\circ}\text{C}$ , unless otherwise specified)				
PARAMETER	TEST CONDITION	SYMBOL	VALUE	UNIT
Climatic classification	According to IEC 68 part 1		55 / 100 / 21	
Pollution degree	According to DIN VDE 0109		2	
Comparative tracking index	Insulation group IIIa	CTI	175	
Maximum rated withstanding isolation voltage	According to UL1577, $t = 1\text{ min}$	$V_{ISO}$	3333	$V_{RMS}$
Maximum transient isolation voltage	According to DIN EN 60747-5-5	$V_{IOTM}$	6000	$V_{peak}$
Maximum repetitive peak isolation voltage	According to DIN EN 60747-5-5	$V_{IORM}$	560	$V_{peak}$
Isolation resistance	$T_{amb} = 25\text{ }^{\circ}\text{C}$ , $V_{IO} = 500\text{ V}$	$R_{IO}$	$\geq 10^{12}$	$\Omega$
	$T_{amb} = 100\text{ }^{\circ}\text{C}$ , $V_{IO} = 500\text{ V}$	$R_{IO}$	$\geq 10^{11}$	$\Omega$
Output safety power		$P_{SO}$	350	mW
Input safety current		$I_{SI}$	150	mA
Input safety temperature		$T_S$	165	$^{\circ}\text{C}$
Creepage distance			$\geq 4$	mm
Clearance distance			$\geq 4$	mm
Insulation thickness		DTI	$\geq 0.2$	mm

**Note**

- As per IEC 60747-5-5, §7.4.3.8.2, this optocoupler is suitable for “safe electrical insulation” only within the safety ratings. Compliance with the safety ratings shall be ensured by means of protective circuits

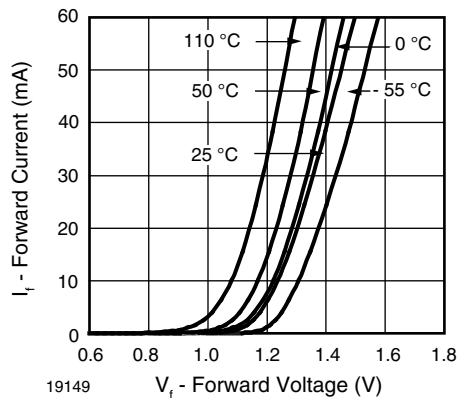
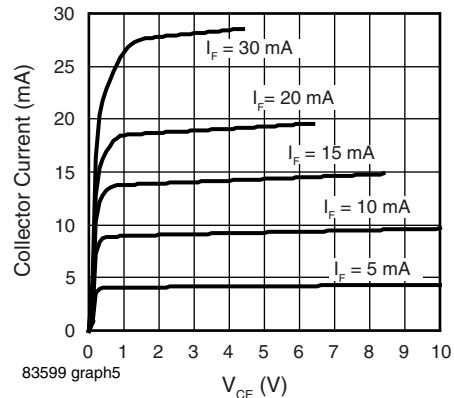
**TYPICAL CHARACTERISTICS** ( $T_{amb} = 25\text{ }^{\circ}\text{C}$ , unless otherwise specified)


Fig. 3 - Forward Current vs. Forward Voltage


 Fig. 4 -  $V_{CE}$  vs.  $I_C$ , (Non-Saturated)

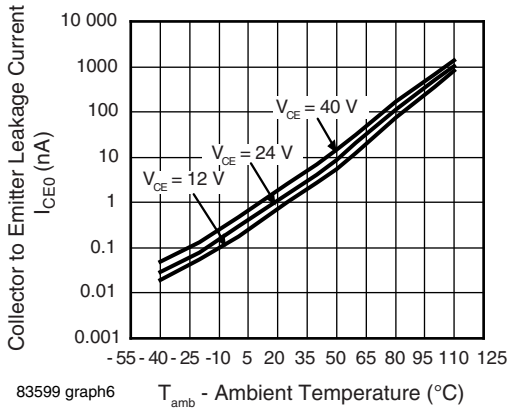


Fig. 5 - Collector to Emitter Leakage Current vs. Ambient Temperature

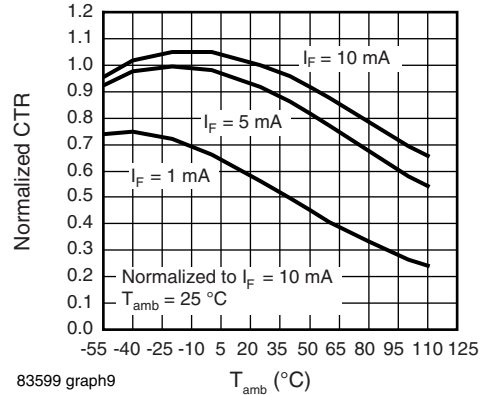


Fig. 8 - Normalized CTR vs. Ambient Temperature (Non-Saturated,  $V_{CE} = 5 V$ )

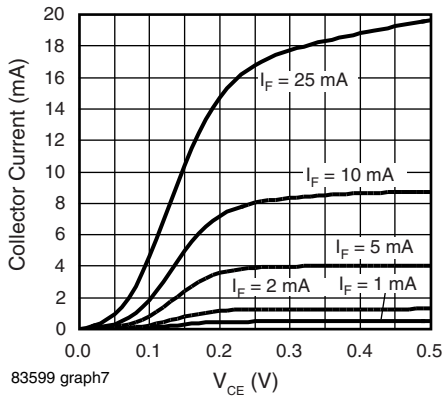


Fig. 6 -  $V_{CE}$  vs.  $I_C$ , (Saturated)

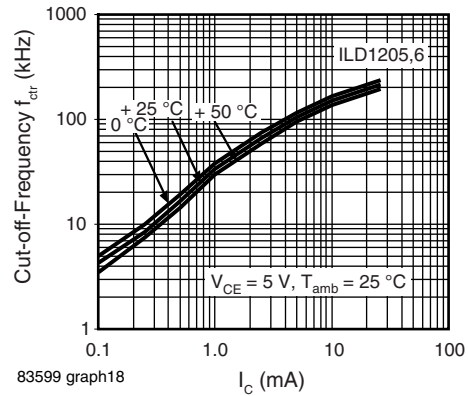


Fig. 9 - Cut-off-Frequency (- 3 dB) vs. Collector Current

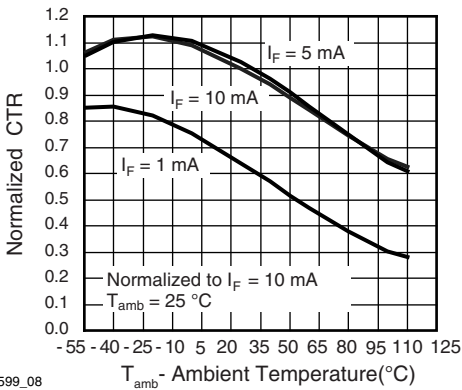


Fig. 7 - Normalized CTR vs. Ambient Temperature (Saturated,  $V_{CE} = 0.4 V$ )

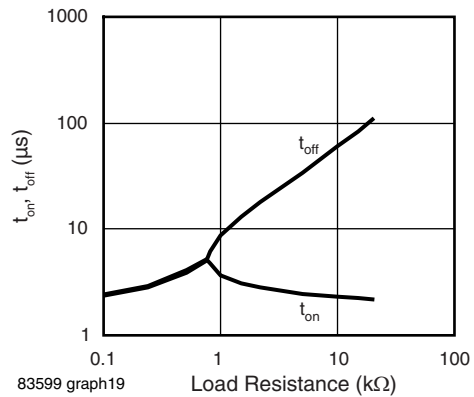
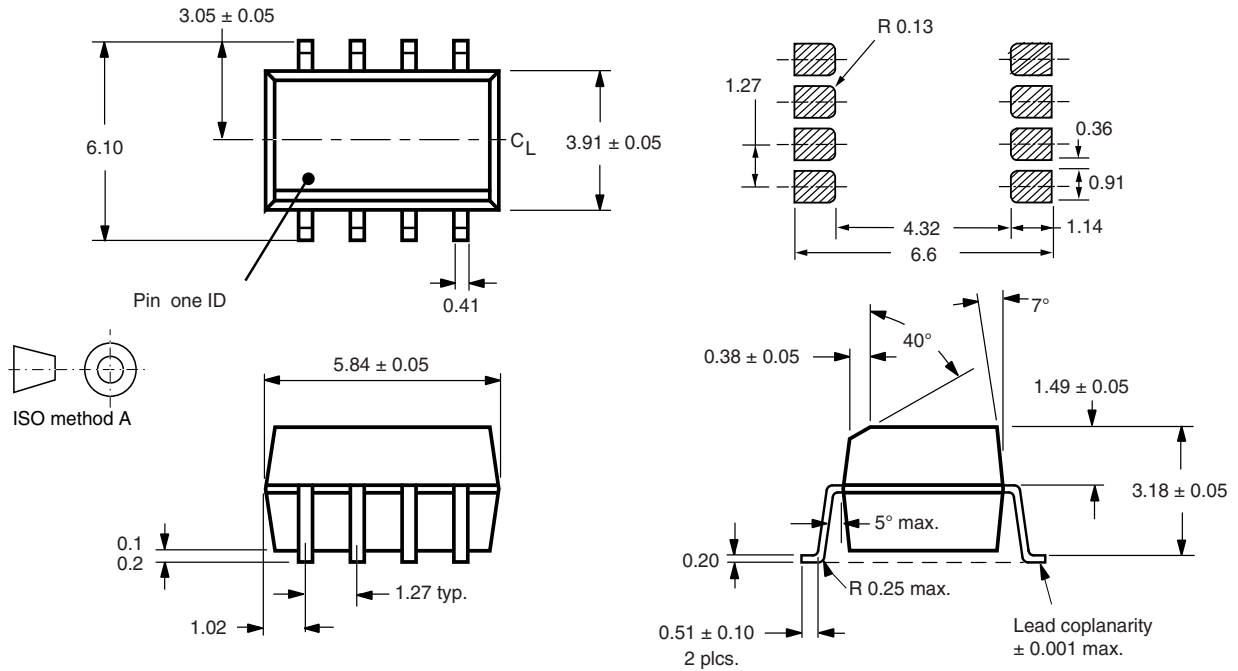


Fig. 10 -  $t_{on}$ ,  $t_{off}$  vs. Load Resistance (100  $\Omega$  to 20 000  $\Omega$ )



**PACKAGE DIMENSIONS** (in millimeters)



i178020



## Disclaimer

ALL PRODUCT, PRODUCT SPECIFICATIONS AND DATA ARE SUBJECT TO CHANGE WITHOUT NOTICE TO IMPROVE RELIABILITY, FUNCTION OR DESIGN OR OTHERWISE.

Vishay Intertechnology, Inc., its affiliates, agents, and employees, and all persons acting on its or their behalf (collectively, "Vishay"), disclaim any and all liability for any errors, inaccuracies or incompleteness contained in any datasheet or in any other disclosure relating to any product.

Vishay makes no warranty, representation or guarantee regarding the suitability of the products for any particular purpose or the continuing production of any product. To the maximum extent permitted by applicable law, Vishay disclaims (i) any and all liability arising out of the application or use of any product, (ii) any and all liability, including without limitation special, consequential or incidental damages, and (iii) any and all implied warranties, including warranties of fitness for particular purpose, non-infringement and merchantability.

Statements regarding the suitability of products for certain types of applications are based on Vishay's knowledge of typical requirements that are often placed on Vishay products in generic applications. Such statements are not binding statements about the suitability of products for a particular application. It is the customer's responsibility to validate that a particular product with the properties described in the product specification is suitable for use in a particular application. Parameters provided in datasheets and / or specifications may vary in different applications and performance may vary over time. All operating parameters, including typical parameters, must be validated for each customer application by the customer's technical experts. Product specifications do not expand or otherwise modify Vishay's terms and conditions of purchase, including but not limited to the warranty expressed therein.

Hyperlinks included in this datasheet may direct users to third-party websites. These links are provided as a convenience and for informational purposes only. Inclusion of these hyperlinks does not constitute an endorsement or an approval by Vishay of any of the products, services or opinions of the corporation, organization or individual associated with the third-party website. Vishay disclaims any and all liability and bears no responsibility for the accuracy, legality or content of the third-party website or for that of subsequent links.

Except as expressly indicated in writing, Vishay products are not designed for use in medical, life-saving, or life-sustaining applications or for any other application in which the failure of the Vishay product could result in personal injury or death. Customers using or selling Vishay products not expressly indicated for use in such applications do so at their own risk. Please contact authorized Vishay personnel to obtain written terms and conditions regarding products designed for such applications.

No license, express or implied, by estoppel or otherwise, to any intellectual property rights is granted by this document or by any conduct of Vishay. Product names and markings noted herein may be trademarks of their respective owners.