

# Surface Mount Schottky Power Rectifier

## SMA/SMB Power Surface Mount Package



ON Semiconductor®

[www.onsemi.com](http://www.onsemi.com)

### MBRS2H100T3G, NBR2H100T3G, MBRA2H100T3G, NRVBA2H100T3G, NRVBA2H100NT3G

This device employs the Schottky Barrier principle in a metal-to-silicon power rectifier. Features epitaxial construction with oxide passivation and metal overlay contact. Ideally suited for low voltage, high frequency switching power supplies; free wheeling diodes and polarity protection diodes.

#### Features

- Compact Package with J-Bend Leads Ideal for Automated Handling
- Highly Stable Oxide Passivated Junction
- Guard-Ring for Overvoltage Protection
- Low Forward Voltage Drop
- NBR and NRVB Prefixes for Automotive and Other Applications Requiring Unique Site and Control Change Requirements; AEC-Q101 Qualified and PPAP Capable\*

#### Mechanical Characteristics

- Case: Molded Epoxy
- Epoxy Meets UL 94 V-0 @ 0.125 in
- Weight: 70 mg (SMA), 95 mg (SMB) (Approximately)
- Cathode Polarity Band
- Lead and Mounting Surface Temperature for Soldering Purposes: 260°C Max. for 10 Seconds
- Finish: All External Surfaces Corrosion Resistant and Terminal Leads are Readily Solderable
- ESD Ratings:
  - ◆ Machine Model = C
  - ◆ Human Body Model = 3B
- These Devices are Pb-Free and are RoHS Compliant
- Device Meets MSL1 Requirements

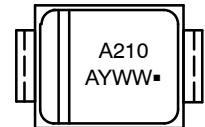
### SCHOTTKY BARRIER RECTIFIER

#### 2.0 AMPERES, 100 VOLTS

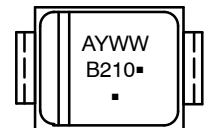
#### MARKING DIAGRAMS



SMA  
CASE 403D



SMB  
CASE 403A



A210 = MBRA2H100T3G  
NRVBA2H100T3G

B210 = MBRS2H100T3G  
NBR2H100T3G

A = Assembly Location

Y = Year

WW = Work Week

▪ = Pb-Free Package

(Note: Microdot may be in either location)

\*\*The Assembly Location code (A) is front side optional. In cases where the Assembly Location is stamped in the package, the front side assembly code may be blank.

#### ORDERING INFORMATION

| Device  | Package          | Shipping†              |
|---|------------------|------------------------|
| MBRA2H100T3G,<br>NRVBA2H100T3G*                     | SMA<br>(Pb-Free) | 5,000 /<br>Tape & Reel |
| MBRS2H100T3G,<br>NBR2H100T3G*,<br>NBR2H100T3G-VF01* | SMB<br>(Pb-Free) | 2,500 /<br>Tape & Reel |
| NRVBA2H100NT3G*                                     | SMA<br>(Pb-Free) | 5,000 /<br>Tape & Reel |

†For information on tape and reel specifications, including part orientation and tape sizes, please refer to our Tape and Reel Packaging Specifications Brochure, BRD8011/D.

# MBRS2H100T3G, NBRS2H100T3G, MBRA2H100T3G, NRVBA2H100T3G, NRVBA2H100NT3G

## MAXIMUM RATINGS

| Rating  | Symbol                          | Value       | Unit             |
|---|---------------------------------|-------------|------------------|
| Peak Repetitive Reverse Voltage<br>Working Peak Reverse Voltage<br>DC Blocking Voltage                      | $V_{RRM}$<br>$V_{RWM}$<br>$V_R$ | 100         | V                |
| Average Rectified Forward Current<br>( $T_L = 150^\circ\text{C}$ )  | $I_O$                           | 2.0         | A                |
| Non-Repetitive Peak Surge Current<br>(Surge Applied at Rated Load Conditions Halfwave, Single Phase, 60 Hz) | $I_{FSM}$                       | 130         | A                |
| Storage Temperature Range   | $T_{stg}$                       | -65 to +175 | $^\circ\text{C}$ |
| Operating Junction Temperature (Note 1)   | $T_J$                           | -65 to +175 | $^\circ\text{C}$ |

Stresses exceeding those listed in the Maximum Ratings table may damage the device. If any of these limits are exceeded, device functionality should not be assumed, damage may occur and reliability may be affected.

1. The heat generated must be less than the thermal conductivity from Junction-to-Ambient:  $dP_D/dT_J < 1/R_{\theta JA}$ .

## THERMAL CHARACTERISTICS

| Characteristic  | Symbol          | Value      | Unit                      |
|---|-----------------|------------|---------------------------|
| Thermal Resistance, Junction-to-Lead (Note 2)<br>MBRA2H100T3G, NRVBA2H100T3G<br>MBRS2H100T3G, NBRS2H100T3G    | $\Psi_{JCL}$    | 14<br>12   | $^\circ\text{C}/\text{W}$ |
| Thermal Resistance, Junction-to-Ambient (Note 2)<br>MBRA2H100T3G, NRVBA2H100T3G<br>MBRS2H100T3G, NBRS2H100T3G | $R_{\theta JA}$ | 75<br>71   | $^\circ\text{C}/\text{W}$ |
| Thermal Resistance, Junction-to-Ambient (Note 3)<br>MBRA2H100T3G, NRVBA2H100T3G<br>MBRS2H100T3G, NBRS2H100T3G | $R_{\theta JA}$ | 275<br>230 | $^\circ\text{C}/\text{W}$ |

2. Mounted with 700 mm square copper pad size (Approximately 1 inch square) 1 oz FR4 Board.

3. Mounted with minimum recommended pad size 1 oz FR4 Board.

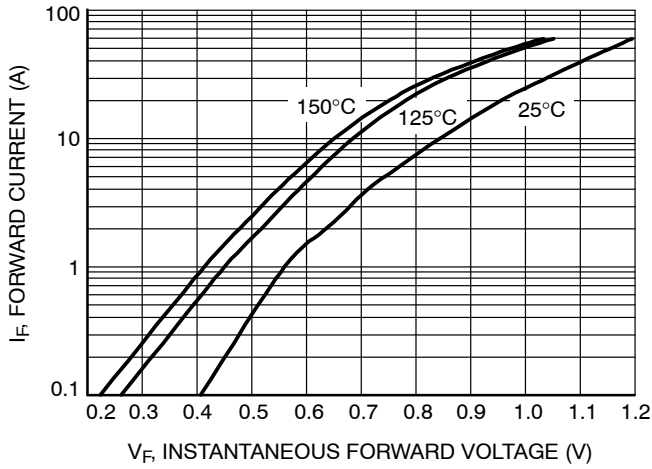
## ELECTRICAL CHARACTERISTICS

| Characteristic  | Symbol | Value                    |                           | Unit |
|---|--------|--------------------------|---------------------------|------|
|   |        | $T_J = 25^\circ\text{C}$ | $T_J = 125^\circ\text{C}$ |      |
| Maximum Instantaneous Forward Voltage (Note 4)<br>( $I_F = 2.0 \text{ A}$ ) | $V_F$  | 0.79                     | 0.65                      | V    |
| Maximum Instantaneous Reverse Current (Note 4)<br>( $V_R = 100 \text{ V}$ ) | $I_R$  | 0.008                    | 1.5                       | mA   |

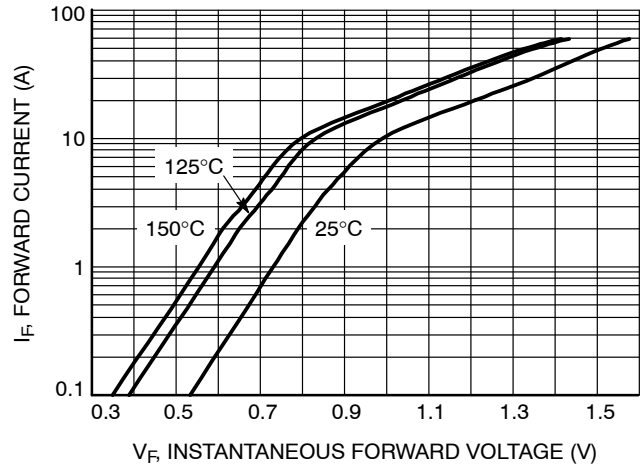
4. Pulse Test: Pulse Width  $\leq 380 \mu\text{s}$ , Duty Cycle  $\leq 2.0\%$ .

**MBRS2H100T3G, NBRS2H100T3G, MBRA2H100T3G, NRVBA2H100T3G,  
NRVBA2H100NT3G**

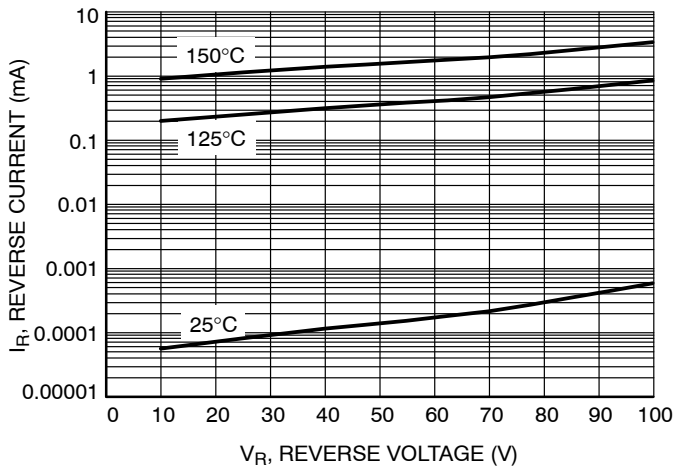
**TYPICAL CHARACTERISTICS**



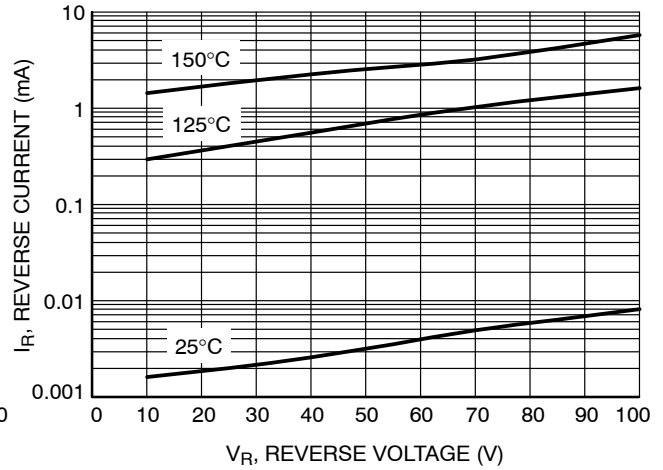
**Figure 1. Typical Forward Voltage**



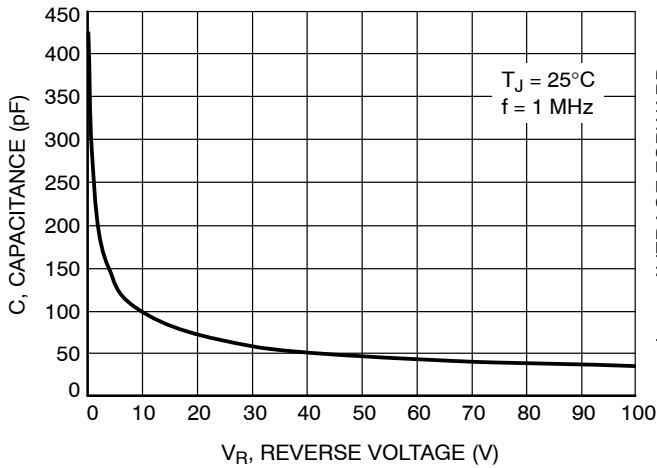
**Figure 2. Maximum Forward Voltage**



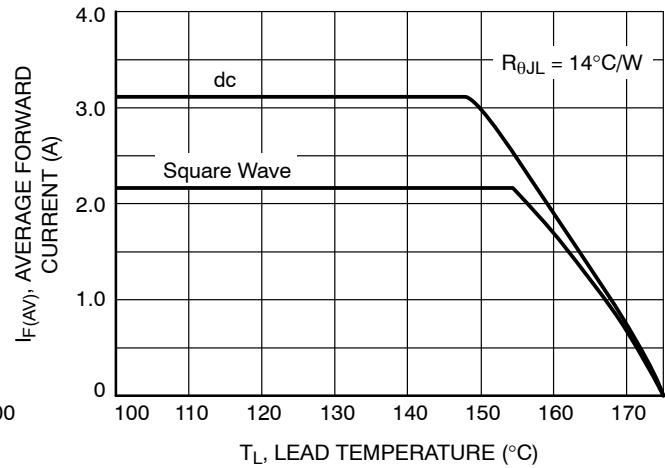
**Figure 3. Typical Reverse Current**



**Figure 4. Maximum Reverse Current**



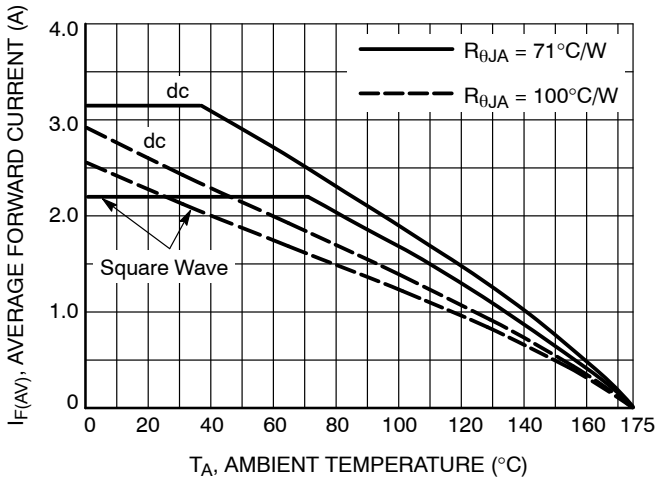
**Figure 5. Typical Capacitance**



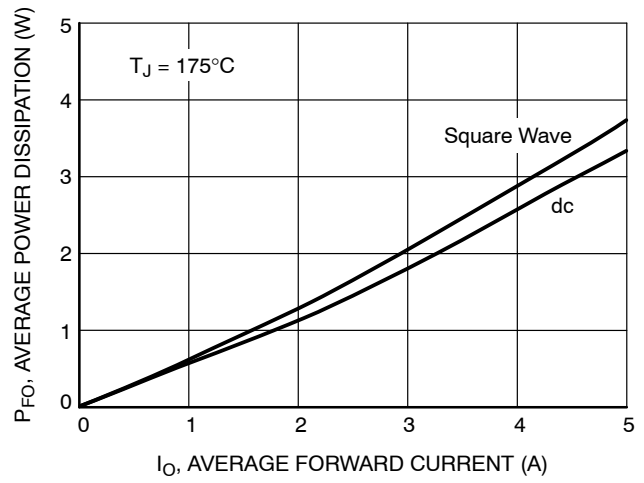
**Figure 6. Current Derating - Lead**

**MBRS2H100T3G, NBR2H100T3G, MBRA2H100T3G, NRVBA2H100T3G,  
NRVBA2H100NT3G**

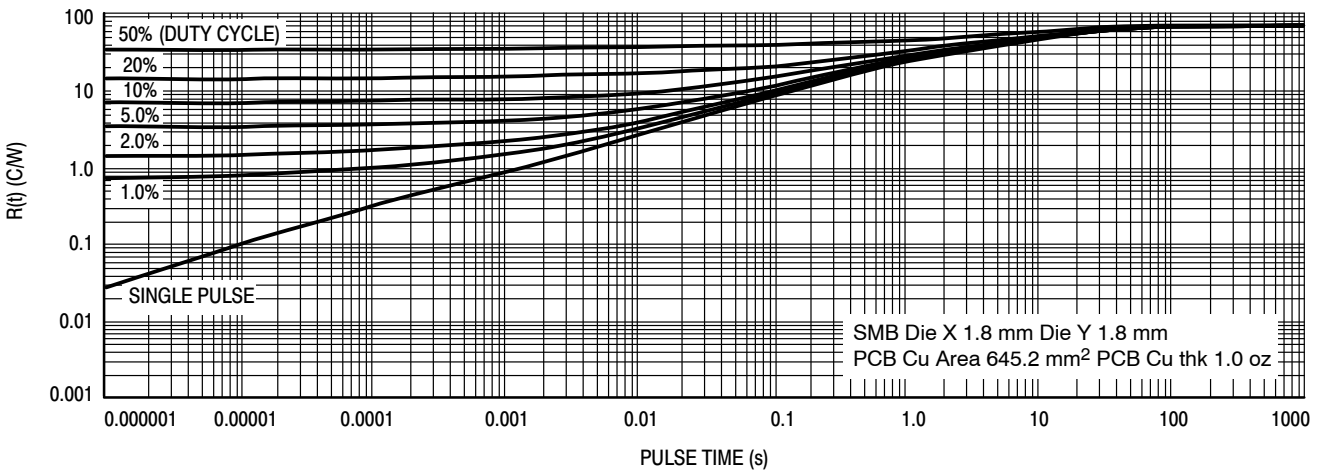
**TYPICAL CHARACTERISTICS**



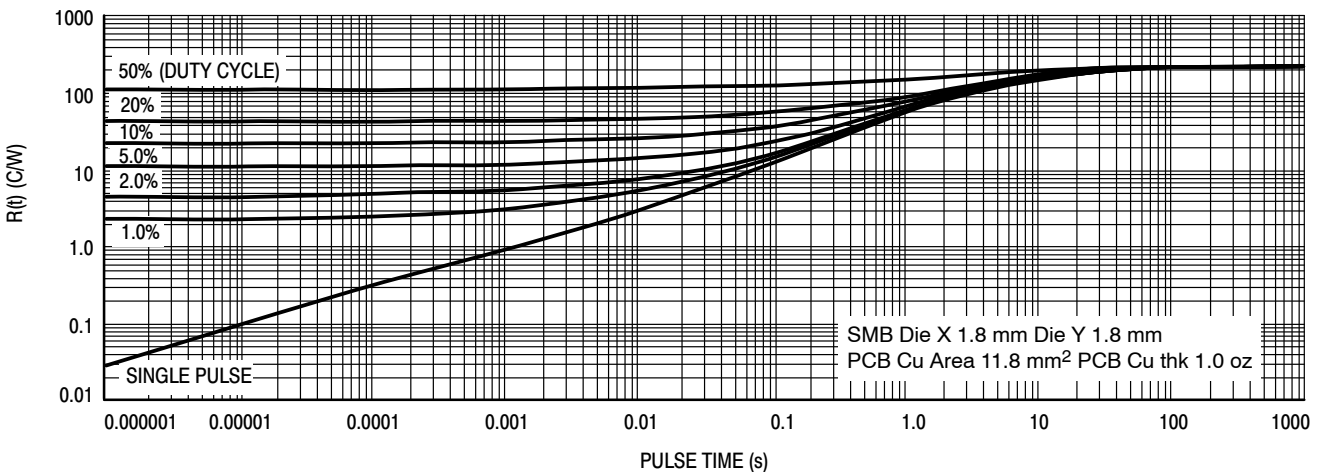
**Figure 7. Current Derating, Ambient**



**Figure 8. Maximum Forward Power Dissipation**

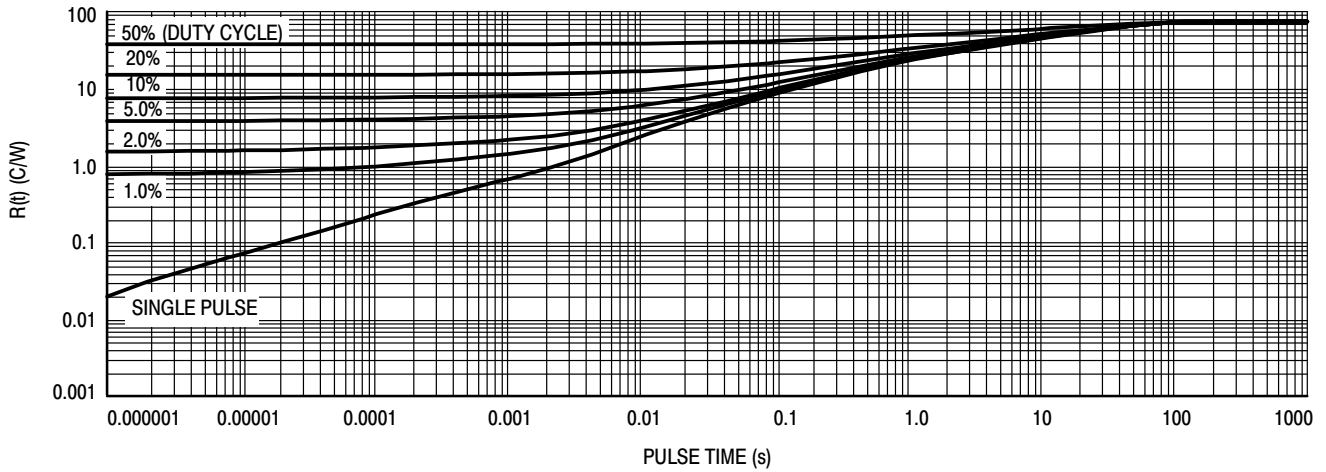


**Figure 9. Thermal Response, Junction-to-Ambient (1 inch pad) – MBRS2H100T3G/NBR2H100T3G**

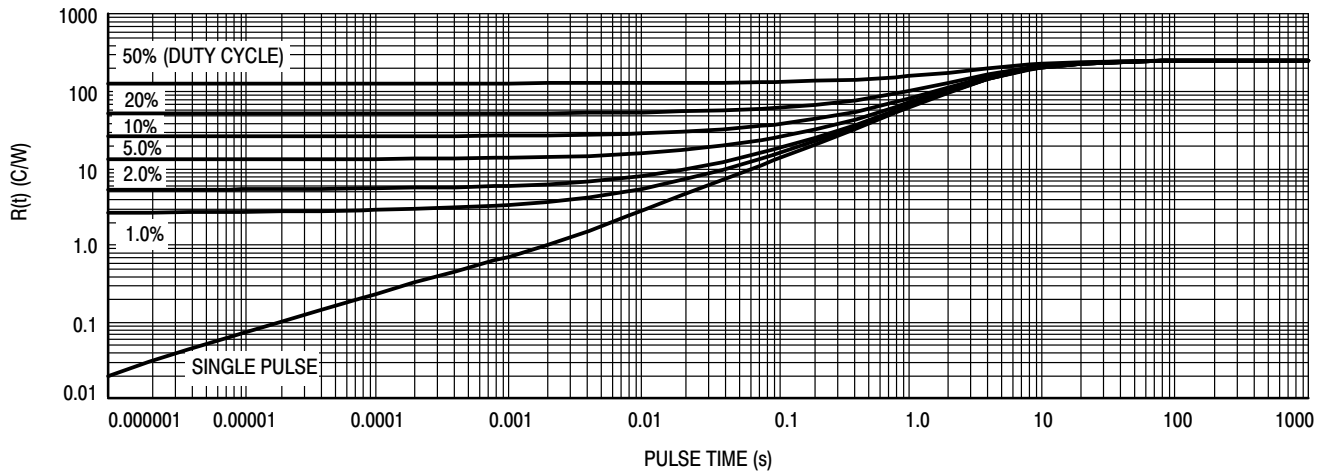


**Figure 10. Thermal Response, Junction-to-Ambient (min pad) – MBRS2H100T3G/NBR2H100T3G**

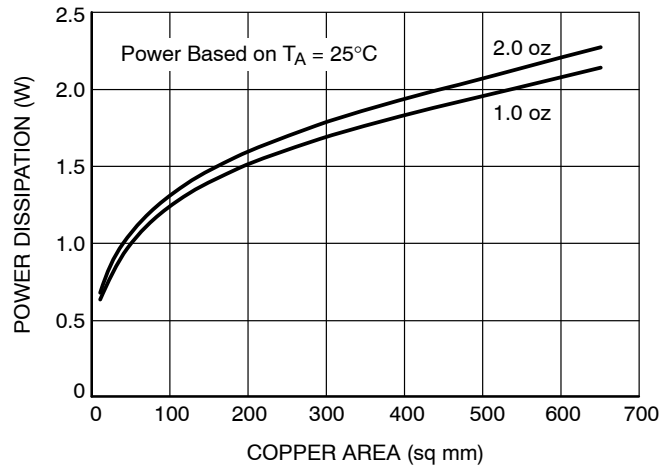
**MBRS2H100T3G, NBR2H100T3G, MBRA2H100T3G, NRVBA2H100T3G,  
NRVBA2H100NT3G  
TYPICAL CHARACTERISTICS**



**Figure 11. Thermal Response, Junction-to-Ambient (1 inch pad) – MBRA2H100T3G/NRVBA2H100T3G**



**Figure 12. Thermal Response, Junction-to-Ambient (min pad) – MBRA2H100T3G/NRVBA2H100T3G**



**Figure 13.  $P_D$ , Junction-to-Ambient (URS copper area)**

# MECHANICAL CASE OUTLINE

## PACKAGE DIMENSIONS

ON Semiconductor®



SCALE 1:1

Polarity Band



SCALE 1:1

Non-Polarity Band

**SMB**  
CASE 403A-03  
ISSUE J

DATE 19 JUL 2012

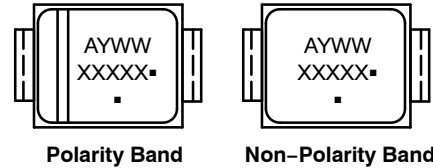


**NOTES:**

1. DIMENSIONING AND TOLERANCING PER ANSI Y14.5M, 1982.
2. CONTROLLING DIMENSION: INCH.
3. DIMENSION b SHALL BE MEASURED WITHIN DIMENSION L1.

| DIM | MILLIMETERS |      |      | INCHES    |       |       |
|-----|-------------|------|------|-----------|-------|-------|
|     | MIN         | NOM  | MAX  | MIN       | NOM   | MAX   |
| A   | 1.95        | 2.30 | 2.47 | 0.077     | 0.091 | 0.097 |
| A1  | 0.05        | 0.10 | 0.20 | 0.002     | 0.004 | 0.008 |
| b   | 1.96        | 2.03 | 2.20 | 0.077     | 0.080 | 0.087 |
| c   | 0.15        | 0.23 | 0.31 | 0.006     | 0.009 | 0.012 |
| D   | 3.30        | 3.56 | 3.95 | 0.130     | 0.140 | 0.156 |
| E   | 4.06        | 4.32 | 4.60 | 0.160     | 0.170 | 0.181 |
| HE  | 5.21        | 5.44 | 5.60 | 0.205     | 0.214 | 0.220 |
| L   | 0.76        | 1.02 | 1.60 | 0.030     | 0.040 | 0.063 |
| L1  | 0.51 REF    |      |      | 0.020 REF |       |       |

**GENERIC MARKING DIAGRAM\***

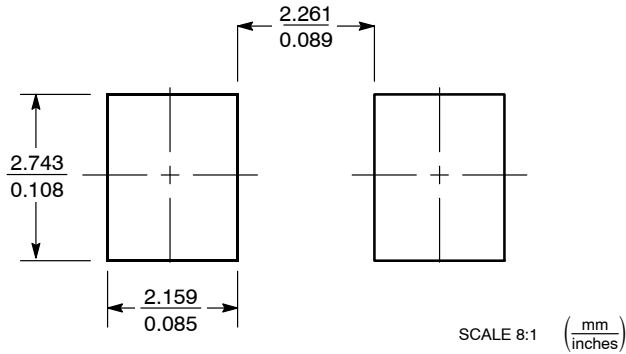


**Polarity Band      Non-Polarity Band**

- XXXXX = Specific Device Code
  - A = Assembly Location
  - Y = Year
  - WW = Work Week
  - = Pb-Free Package
- (Note: Microdot may be in either location)

\*This information is generic. Please refer to device data sheet for actual part marking. Pb-Free indicator, "G" or microdot "▪", may or may not be present.

**SOLDERING FOOTPRINT\***



\*For additional information on our Pb-Free strategy and soldering details, please download the ON Semiconductor Soldering and Mounting Techniques Reference Manual, SOLDERRM/D.

|                         |                    |  |
|-------------------------|--------------------|--|
| <b>DOCUMENT NUMBER:</b> | <b>98ASB42669B</b> | Electronic versions are uncontrolled except when accessed directly from the Document Repository. Printed versions are uncontrolled except when stamped "CONTROLLED COPY" in red. |
| <b>DESCRIPTION:</b>     | <b>SMB</b>         | <b>PAGE 1 OF 1</b>   |

ON Semiconductor and are trademarks of Semiconductor Components Industries, LLC dba ON Semiconductor or its subsidiaries in the United States and/or other countries. ON Semiconductor reserves the right to make changes without further notice to any products herein. ON Semiconductor makes no warranty, representation or guarantee regarding the suitability of its products for any particular purpose, nor does ON Semiconductor assume any liability arising out of the application or use of any product or circuit, and specifically disclaims any and all liability, including without limitation special, consequential or incidental damages. ON Semiconductor does not convey any license under its patent rights nor the rights of others.

# MECHANICAL CASE OUTLINE

## PACKAGE DIMENSIONS

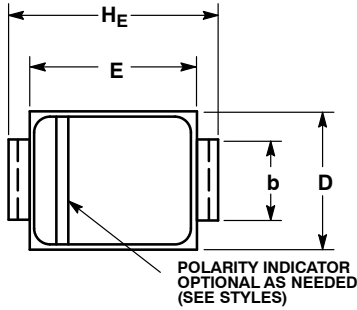
ON Semiconductor®



STYLE 1    STYLE 2  
SCALE 1:1

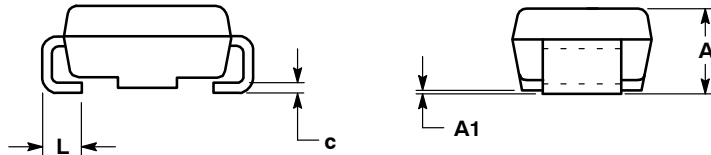
### SMA CASE 403D ISSUE H

DATE 23 SEP 2015

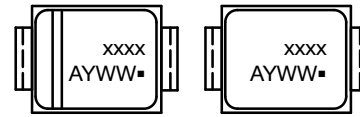


- NOTES:
1. DIMENSIONING AND TOLERANCING PER ANSI Y14.5M, 1982.
  2. CONTROLLING DIMENSION: INCH.
  3. DIMENSION b SHALL BE MEASURED WITHIN DIMENSION L.

| DIM | MILLIMETERS |      |      | INCHES |       |       |
|-----|-------------|------|------|--------|-------|-------|
|     | MIN         | NOM  | MAX  | MIN    | NOM   | MAX   |
| A   | 1.97        | 2.10 | 2.20 | 0.078  | 0.083 | 0.087 |
| A1  | 0.05        | 0.10 | 0.20 | 0.002  | 0.004 | 0.008 |
| b   | 1.27        | 1.45 | 1.63 | 0.050  | 0.057 | 0.064 |
| c   | 0.15        | 0.28 | 0.41 | 0.006  | 0.011 | 0.016 |
| D   | 2.29        | 2.60 | 2.92 | 0.090  | 0.103 | 0.115 |
| E   | 4.06        | 4.32 | 4.57 | 0.160  | 0.170 | 0.180 |
| HE  | 4.83        | 5.21 | 5.59 | 0.190  | 0.205 | 0.220 |
| L   | 0.76        | 1.14 | 1.52 | 0.030  | 0.045 | 0.060 |



### GENERIC MARKING DIAGRAM\*

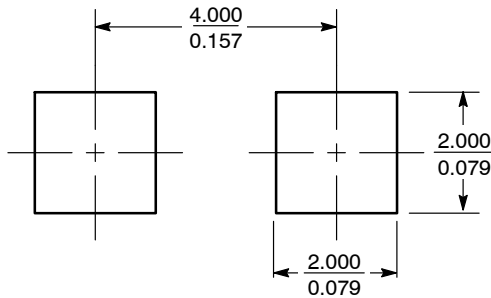


STYLE 1                      STYLE 2

- xxxx = Specific Device Code
- A = Assembly Location
- Y = Year
- WW = Work Week
- = Pb-Free Package

\*This information is generic. Please refer to device data sheet for actual part marking. Pb-Free indicator, "G" or microdot "■", may or may not be present.

### SOLDERING FOOTPRINT\*



SCALE 8:1 (mm/inches)

\*For additional information on our Pb-Free strategy and soldering details, please download the ON Semiconductor Soldering and Mounting Techniques Reference Manual, SOLDERRM/D.

- STYLE 1:                      STYLE 2:
1. CATHODE (POLARITY BAND)
  2. ANODE
- NO POLARITY

|                         |                    |  |
|-------------------------|--------------------|--|
| <b>DOCUMENT NUMBER:</b> | <b>98AON04079D</b> | Electronic versions are uncontrolled except when accessed directly from the Document Repository. Printed versions are uncontrolled except when stamped "CONTROLLED COPY" in red. |
| <b>DESCRIPTION:</b>     | <b>SMA</b>         | <b>PAGE 1 OF 1</b>   |

ON Semiconductor and are trademarks of Semiconductor Components Industries, LLC dba ON Semiconductor or its subsidiaries in the United States and/or other countries. ON Semiconductor reserves the right to make changes without further notice to any products herein. ON Semiconductor makes no warranty, representation or guarantee regarding the suitability of its products for any particular purpose, nor does ON Semiconductor assume any liability arising out of the application or use of any product or circuit, and specifically disclaims any and all liability, including without limitation special, consequential or incidental damages. ON Semiconductor does not convey any license under its patent rights nor the rights of others.

ON Semiconductor and  are trademarks of Semiconductor Components Industries, LLC dba ON Semiconductor or its subsidiaries in the United States and/or other countries. ON Semiconductor owns the rights to a number of patents, trademarks, copyrights, trade secrets, and other intellectual property. A listing of ON Semiconductor's product/patent coverage may be accessed at [www.onsemi.com/site/pdf/Patent-Marking.pdf](http://www.onsemi.com/site/pdf/Patent-Marking.pdf). ON Semiconductor reserves the right to make changes without further notice to any products herein. ON Semiconductor makes no warranty, representation or guarantee regarding the suitability of its products for any particular purpose, nor does ON Semiconductor assume any liability arising out of the application or use of any product or circuit, and specifically disclaims any and all liability, including without limitation special, consequential or incidental damages. Buyer is responsible for its products and applications using ON Semiconductor products, including compliance with all laws, regulations and safety requirements or standards, regardless of any support or applications information provided by ON Semiconductor. "Typical" parameters which may be provided in ON Semiconductor data sheets and/or specifications can and do vary in different applications and actual performance may vary over time. All operating parameters, including "Typicals" must be validated for each customer application by customer's technical experts. ON Semiconductor does not convey any license under its patent rights nor the rights of others. ON Semiconductor products are not designed, intended, or authorized for use as a critical component in life support systems or any FDA Class 3 medical devices or medical devices with a same or similar classification in a foreign jurisdiction or any devices intended for implantation in the human body. Should Buyer purchase or use ON Semiconductor products for any such unintended or unauthorized application, Buyer shall indemnify and hold ON Semiconductor and its officers, employees, subsidiaries, affiliates, and distributors harmless against all claims, costs, damages, and expenses, and reasonable attorney fees arising out of, directly or indirectly, any claim of personal injury or death associated with such unintended or unauthorized use, even if such claim alleges that ON Semiconductor was negligent regarding the design or manufacture of the part. ON Semiconductor is an Equal Opportunity/Affirmative Action Employer. This literature is subject to all applicable copyright laws and is not for resale in any manner.

## PUBLICATION ORDERING INFORMATION

### LITERATURE FULFILLMENT:

Email Requests to: [orderlit@onsemi.com](mailto:orderlit@onsemi.com)

ON Semiconductor Website: [www.onsemi.com](http://www.onsemi.com)

### TECHNICAL SUPPORT

North American Technical Support:  
Voice Mail: 1 800-282-9855 Toll Free USA/Canada  
Phone: 011 421 33 790 2910

### Europe, Middle East and Africa Technical Support:

Phone: 00421 33 790 2910

For additional information, please contact your local Sales Representative



# Mouser Electronics

Authorized Distributor

Click to View Pricing, Inventory, Delivery & Lifecycle Information:

## ON Semiconductor:

[MBRA2H100T3G](#) [MBRS2H100T3G](#) [NBRS2H100T3G](#) [NRVBA2H100T3G](#) [NBRS2H100T3G-VF01](#)  
[NRVBA2H100T3G-VF01](#) [NRVBA2H100NT3G](#) [SNBRS2H100T3G](#)