

Molding Type Power Inductor

ASPI-0630LR



RoHS
Compliant



7.2 x 6.65 x 3.0 mm

FEATURES:

- High saturation current.
- Low loss due to low DC resistance.
- Frequency application up to 3MHz.
- Low profile with max thickness 3.0mm.
- 100% lead free and metted RoHS standard.
- Suitable for reflow soldering.
- High reliable SMD package

APPLICATIONS:

- DC/DC converters in Notebook, Netbook, desktop and server
- Low profile, high current power supplies.

STANDARD SPECIFICATIONS

Abrakon P/N:	ASPI-0630LR Series
Operating Temperature & Humidity:	-55°C to +125°C (Including self generated heat)
Storage Temperature & Humidity:	+25°C to +35°C, 45% to 85% RH

Part Number	Inductance	Tolerance	DCR Typ	DCR Max	Saturation Current	Temperature Rise Current
Units	μH	%	mΩ	mΩ	A	A
Symbol	L	M			Isat	Irms
ASPI-0630LR-R47	0.47	M	3.5	4.1	20.0	18.0
ASPI-0630LR-R56	0.56	M	4.7	5.0	18.0	17.0
ASPI-0630LR-R68	0.68	M	6.0	6.5	17.0	16.0
ASPI-0630LR-R82	0.82	M	7.0	7.5	16.0	14.0
ASPI-0630LR-1R0	1.0	M	8.5	9.0	15.0	12.0
ASPI-0630LR-1R5	1.5	M	10.5	12.0	14.0	10.0
ASPI-0630LR-2R2	2.2	M	16.0	18.5	10.0	8.0
ASPI-0630LR-3R3	3.3	M	25.0	28.0	10.0	6.5
ASPI-0630LR-4R7	4.7	M	32.5	35.0	6.5	5.5
ASPI-0630LR-5R6	5.6	M	32.5	35.5	5.0	6.0
ASPI-0630LR-6R8	6.8	M	54.0	60.0	6.0	4.5
ASPI-0630LR-100	10.0	M	62.0	68.0	5.5	4.0
ASPI-0630LR-150	15.0	M	110.0	120.0	5.0	3.0
ASPI-0630LR-220	22.0	M	152.0	167.0	2.5	2.5

Test Conditions

1. Inductance is measured in HP-4284A Precision LCR Meter.
2. RDC is measured in HP-4338B milli ohm meter.(or equivalent).
3. Isat: Based on inductance change ($\Delta L/L_0 : \leq -30\%$)
4. Irms: Based on temperature rise ($\Delta T : 40^\circ\text{C TYP.}$)

ELECTRICAL CHARACTERISTIC CURVES

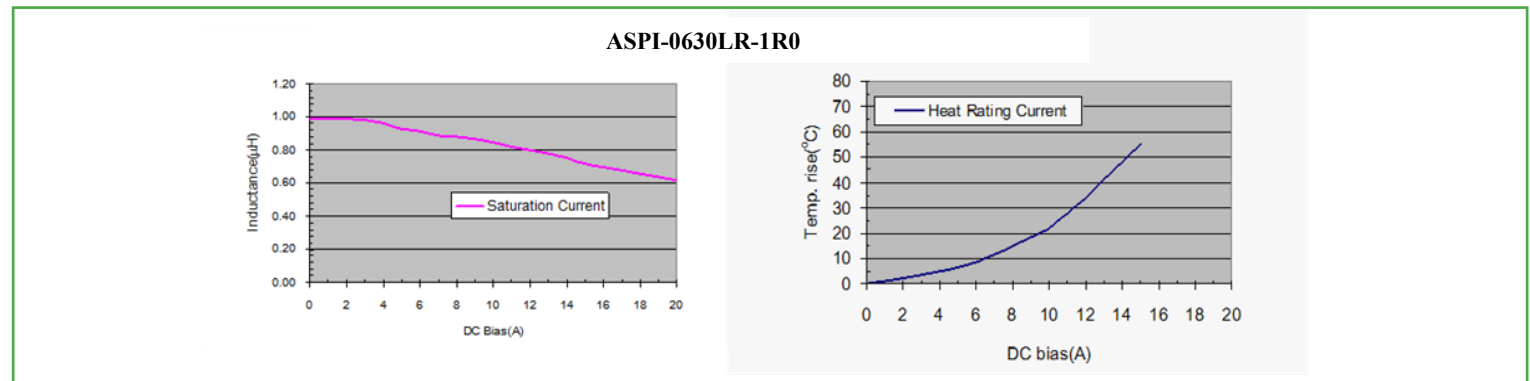

Molding Type Power Inductor

ASPI-0630LR



RoHS
Compliant



7.2 x 6.65 x 3.0 mm

ELECTRICAL CHARACTERISTIC CURVES

ASPI-0630LR-1R5

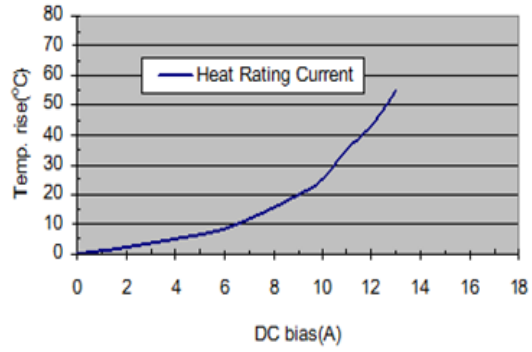
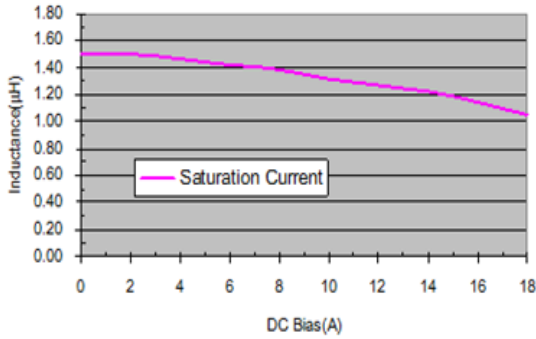

ASPI-0630LR-2R2

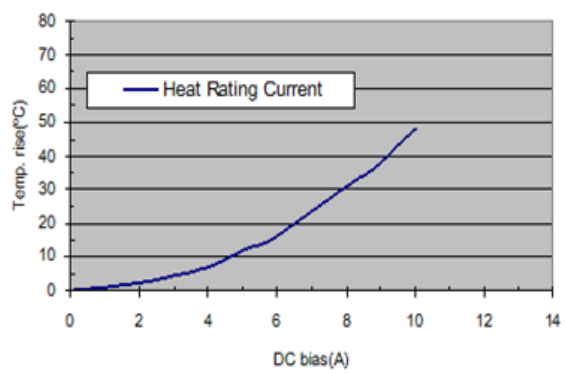
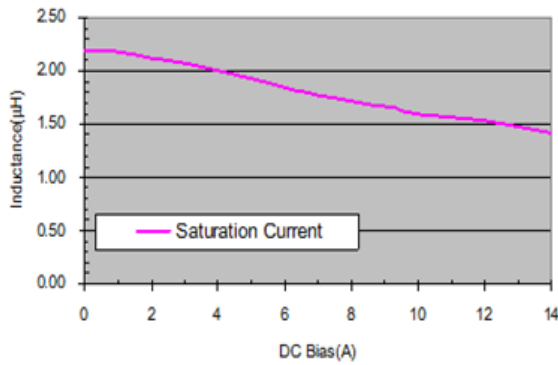

ASPI-0630LR-3R3

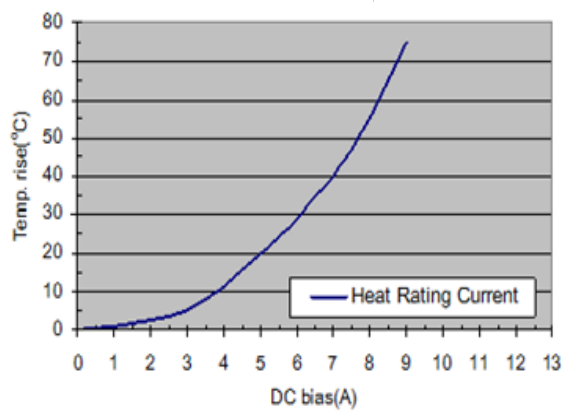
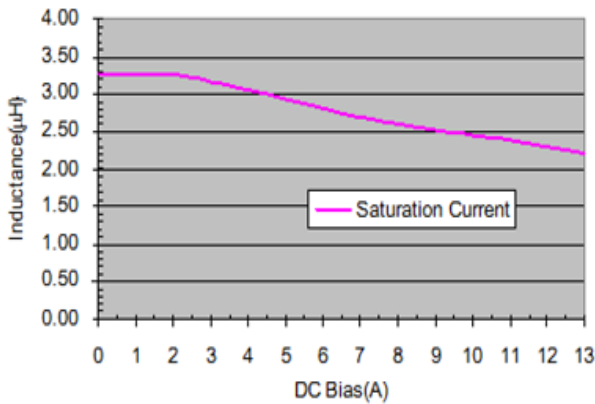

Molding Type Power Inductor

ASPI-0630LR



RoHS
Compliant



7.2 x 6.65 x 3.0 mm

ELECTRICAL CHARACTERISTIC CURVES

ASPI-0630LR-4R7

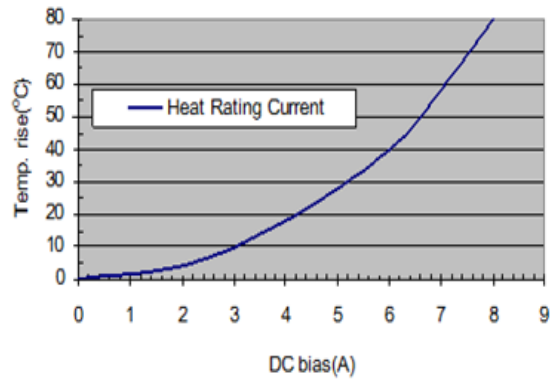
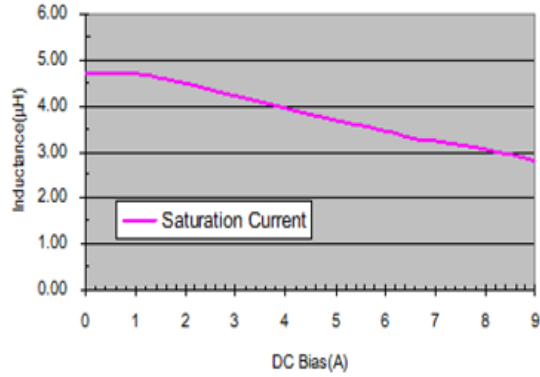

ASPI-0630LR-5R6

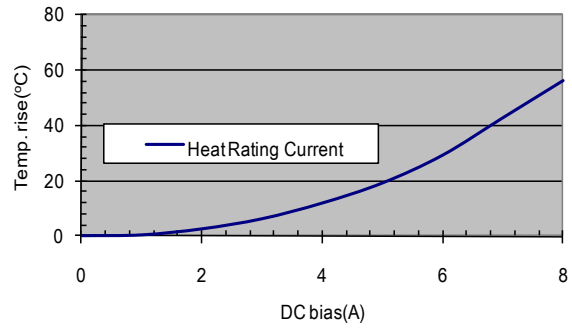
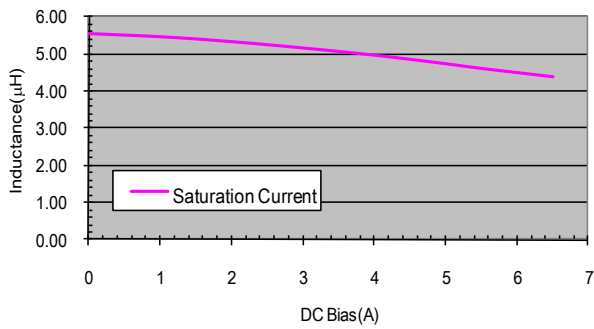

ASPI-0630LR-6R8

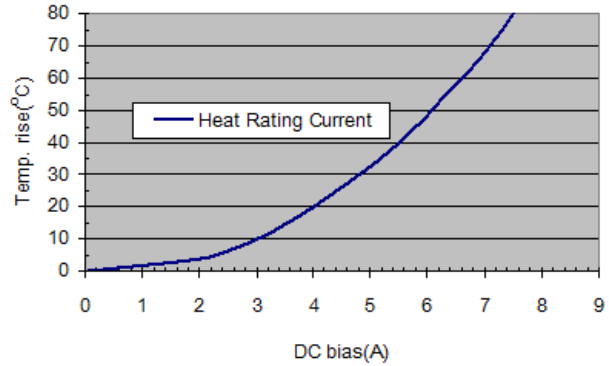
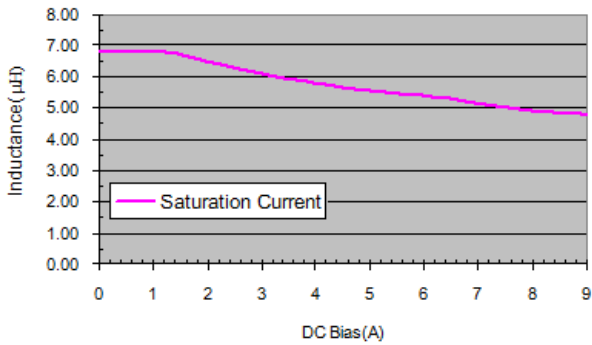

Molding Type Power Inductor

ASPI-0630LR



7.2 x 6.65 x 3.0 mm

ELECTRICAL CHARACTERISTIC CURVES

ASPI-0630LR-100

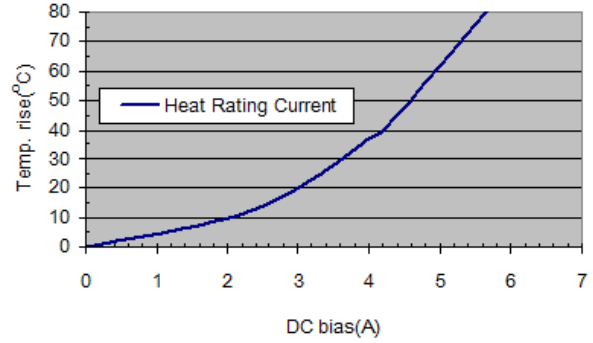
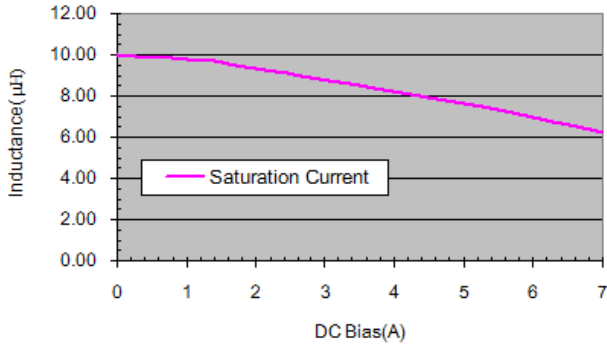

ASPI-0630LR-150

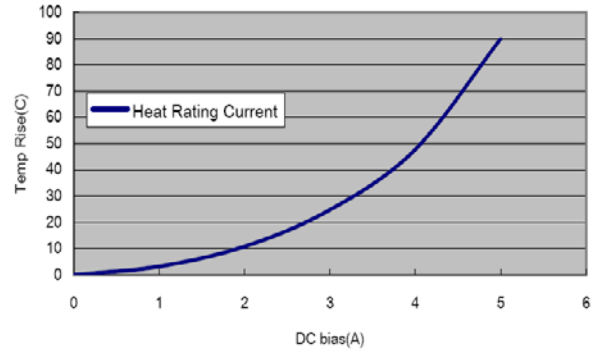
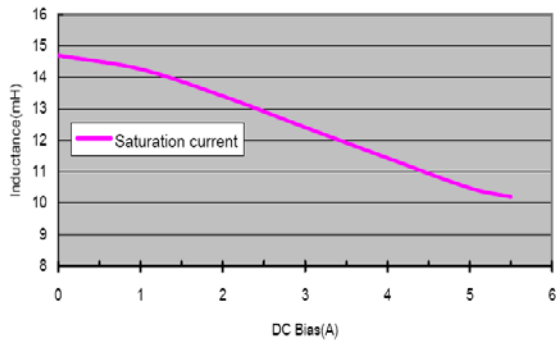

ASPI-0630LR-R47

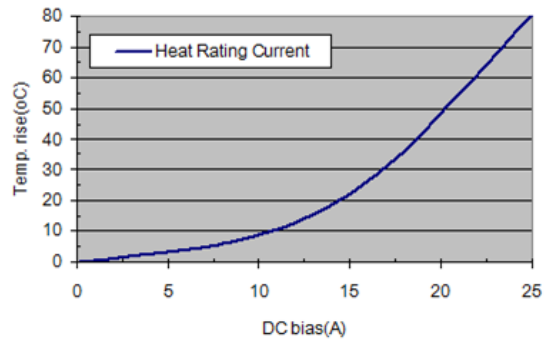
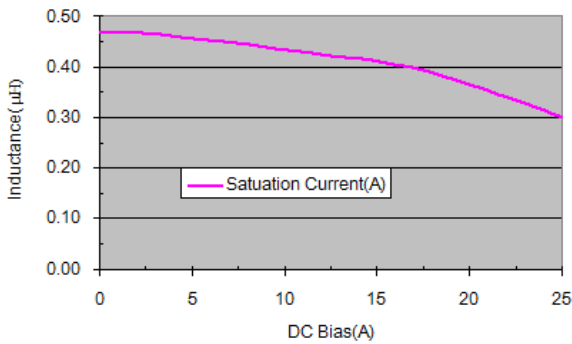

Molding Type Power Inductor

ASPI-0630LR



RoHS
Compliant



7.2 x 6.65 x 3.0 mm

ELECTRICAL CHARACTERISTIC CURVES

ASPI-0630LR-R56

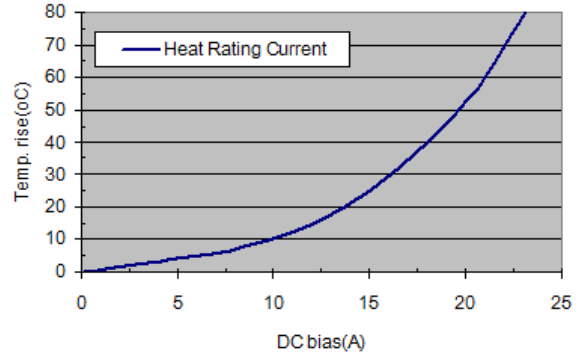
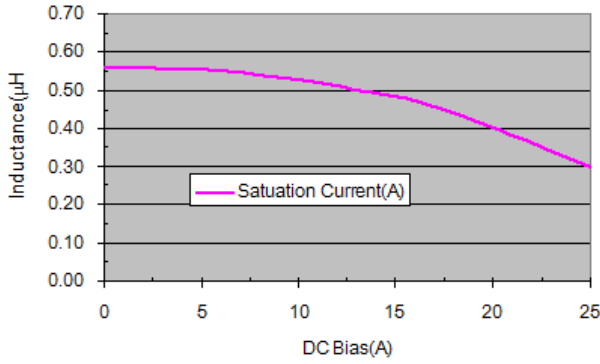

ASPI-0630LR-R68

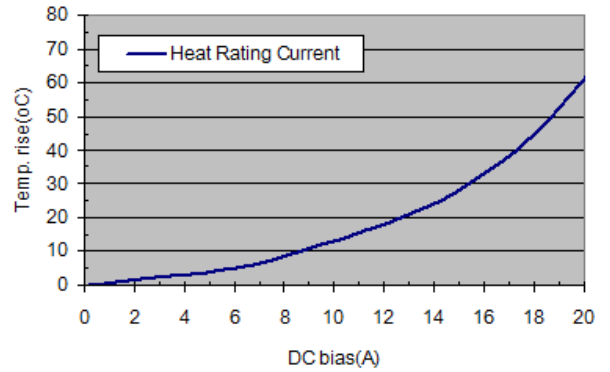
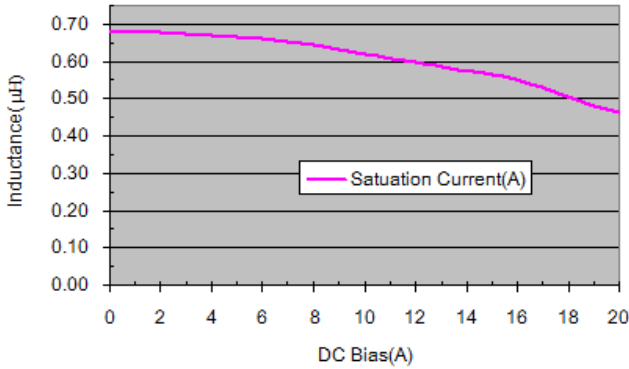

ASPI-0630LR-R82

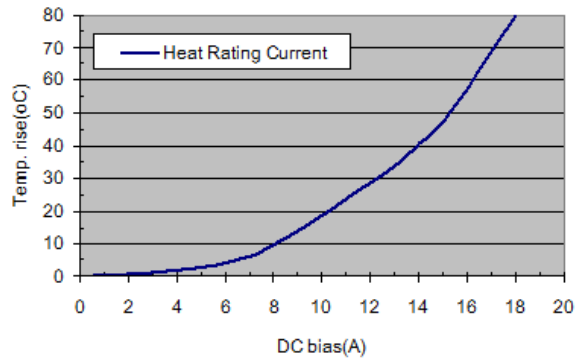
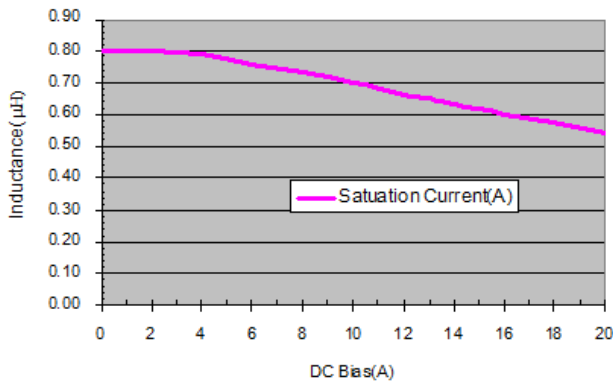

Molding Type Power Inductor

ASPI-0630LR



7.2 x 6.65 x 3.0 mm

PART NUMBER IDENTIFICATION

ASPI-0630LR---

Inductance Code
Please refer to the Electrical Spec Table

Tolerance
M: $\pm 20\%$

Packaging
T15: Tape and Reel (1.5kpcs / reel)

OUTLINE DRAWING:

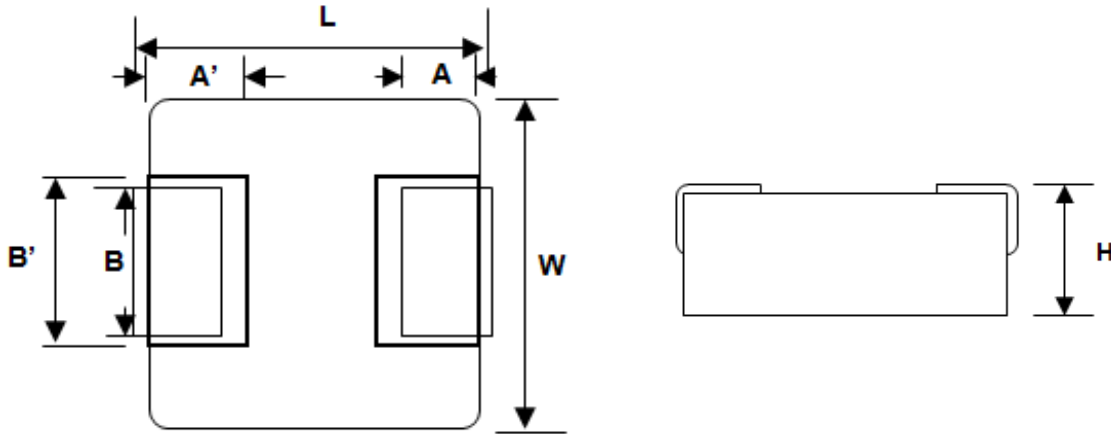

A	A'	B	B'	L	W	H max
1.6 ± 0.4	2.0 ± 0.1	3.0 ± 0.3	3.4 ± 0.2	7.2 ± 0.3	6.65 ± 0.2	3.0

Recommended Land Pattern

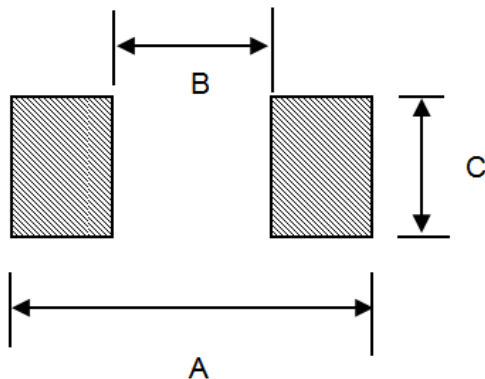

A	B	C
8.4	3.7	3.4

Dimension: mm

Molding Type Power Inductor

ASPI-0630LR



RoHS
Compliant



7.2 x 6.65 x 3.0 mm

TAPE & REEL:

T1: 1,500pcs / reel

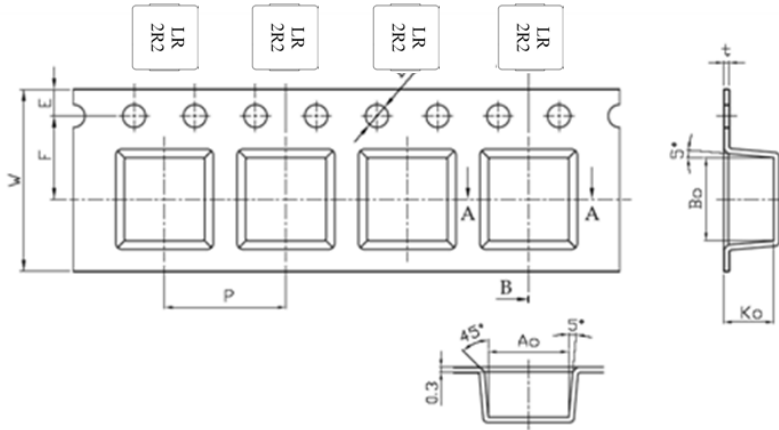

A0	7.2
B0	7.5
K0	3.6
P	12.0
t	0.3
W	16
E	1.75
F	7.5
D	1.5

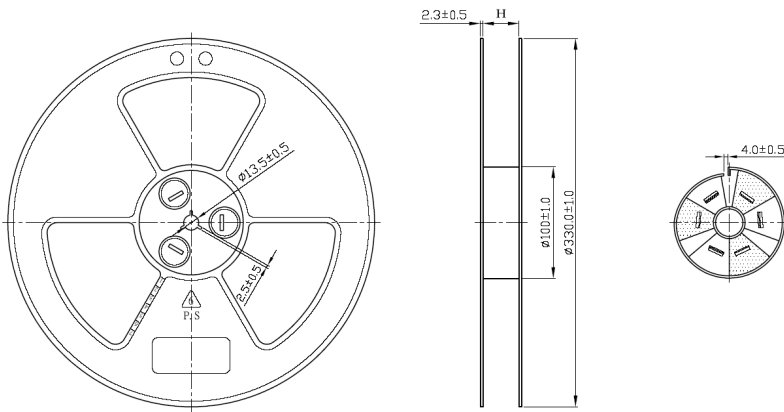

Dimension: mm

Molding Type Power Inductor

ASPI-0630LR



RoHS
Compliant



7.2 x 6.65 x 3.0 mm

REFLOW PROFILE:

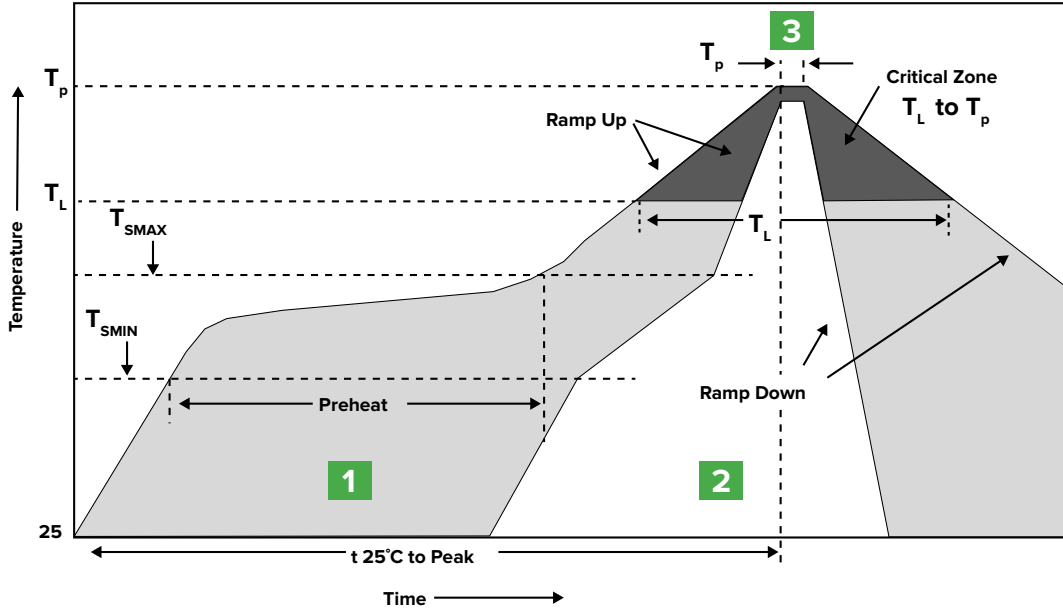

Zone	Description	Temperature	Times
1	Preheat	T_{SMIN} to T_{SMAX} 150°C to 200°C	60 to 120 sec.
2	Reflow	T_L 217°C	60 to 150 sec.
3	Peak heat	T_P 260°C	30 sec. MAX

ATTENTION: Abracon LLC's products are COTS – Commercial-Off-The-Shelf products; suitable for Commercial, Industrial and, where designated, Automotive Applications. Abracon's products are not specifically designed for Military, Aviation, Aerospace, Life-dependant Medical applications or any application requiring high reliability where component failure could result in loss of life and/or property. For applications requiring high reliability and/or presenting an extreme operating environment, written consent and authorization from Abracon LLC is required. Please contact Abracon LLC for more information.

Mouser Electronics

Authorized Distributor

Click to View Pricing, Inventory, Delivery & Lifecycle Information:

ABRACON:

[ASPI-0630LR-100M-T15](#) [ASPI-0630LR-150M-T15](#) [ASPI-0630LR-1R0M-T15](#) [ASPI-0630LR-1R5M-T15](#) [ASPI-0630LR-220M-T15](#) [ASPI-0630LR-2R2M-T15](#) [ASPI-0630LR-3R3M-T15](#) [ASPI-0630LR-4R7M-T15](#) [ASPI-0630LR-5R6M-T15](#) [ASPI-0630LR-6R8M-T15](#) [ASPI-0630LR-R47M-T15](#) [ASPI-0630LR-R56M-T15](#) [ASPI-0630LR-R68M-T15](#) [ASPI-0630LR-R82M-T15](#)