

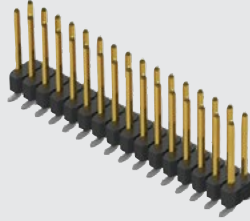

(2.54 mm) .100"

TSM-116-02-S-DV-LC



TSM-121-01-T-SV

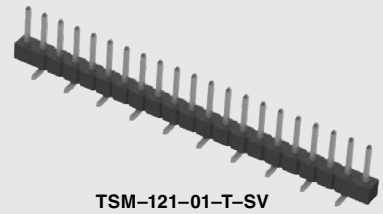

# SMT .025" SQ POST HEADER

**Board Mates:**

SSW, SSQ, SSM, BSW, ESW, ESQ, BCS, SLW, CES, HLE

**Cable Mates:**

IDSS, IDSD

**SPECIFICATIONS**

For complete specifications and recommended PCB layouts see [www.samtec.com?TSM](http://www.samtec.com?TSM)

**Insulator Material:** Black Liquid Crystal Polymer  
**Terminal Material:** Phosphor Bronze  
**Plating:** Au or Sn over 50 μm (1.27 μm) Ni

**Operating Temp Range:** -55 °C to +105 °C with Tin; -55 °C to +125 °C with Gold  
**Voltage Rating:** 475 VAC -SV/-DV mated with BCS or SSM  
**RoHS Compliant:** Yes

MATES	CURRENT RATING (PER PIN)
TSM/SSW	4.7 A
TSM/SSM	5.4 A
TSM/HLE	4.1 A
<b>2 PINS POWERED</b>	

**PROCESSING**

**Lead-Free Solderable:** Yes  
**-DH/-SH Lead Coplanarity:** (0.15 mm) .006" max (02-36)\*  
**-DV/-SV Lead Coplanarity:** (0.10 mm) .004" max (02-05) (0.13 mm) .005" max (06-10)\* (0.15 mm) .006" max (11-36)\*  
 \*(.004" stencil solution may be available; contact [IPG@samtec.com](mailto:IPG@samtec.com))

**RECOGNITIONS**

For complete scope of recognitions see [www.samtec.com/quality](http://www.samtec.com/quality)



**ALSO AVAILABLE (MOQ Required)**

- Edge Mount and Locking Clips for -SV
- Solder Locks for -DH and Shrouds for -DV
- Other platings

**Note:** Some lengths, styles and options are non-standard, non-returnable.

<b>TSM</b>	<b>1</b>	<b>NO. PINS PER ROW</b>	<b>LEAD STYLE</b>	<b>PLATING OPTION</b>	<b>ROW OPTION</b>
		<b>02 thru 36</b>	<p><b>-01</b> = .230" (5.84 mm) Post Height (Mates with SSW, BCS, SSM, IDSS, IDSD)</p> <p><b>-02</b> = .320" (8.13 mm) Post Height (Mates with SSM -DH)</p> <p><b>-03</b> = .420" (10.67 mm) Post Height (For Bottom Mount &amp; Pass Through)</p> <p><b>-04</b> = .120" (3.05 mm) Post Height (Mates with SLW, CES, HLE)</p>	<p><b>-F</b> = Gold flash on post, Matte Tin on tail</p> <p><b>-L</b> = 10 μm (0.25 μm) Gold on post, Matte Tin on tail</p> <p><b>-S</b> = 30 μm (0.76 μm) Gold on post, Matte Tin on tail</p> <p><b>-T</b> = Matte Tin</p>	

**APPLICATIONS**

**HIGH-SPEED CHANNEL PERFORMANCE**

Rating based on Samtec reference channel. For full SI performance data visit [Samtec.com](http://Samtec.com) or contact [SIG@samtec.com](mailto:SIG@samtec.com)

**8** Gbps

**-SV = Single Row Vertical Pin**

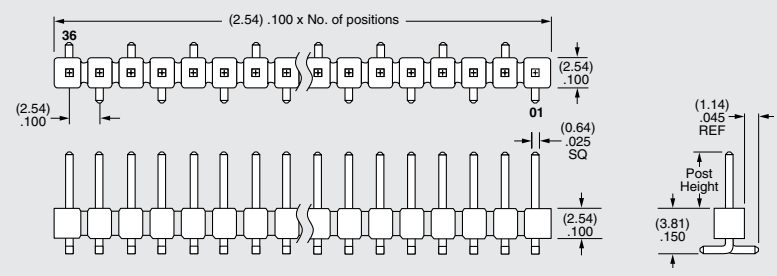

**-SH = Single Row Horizontal Pin**

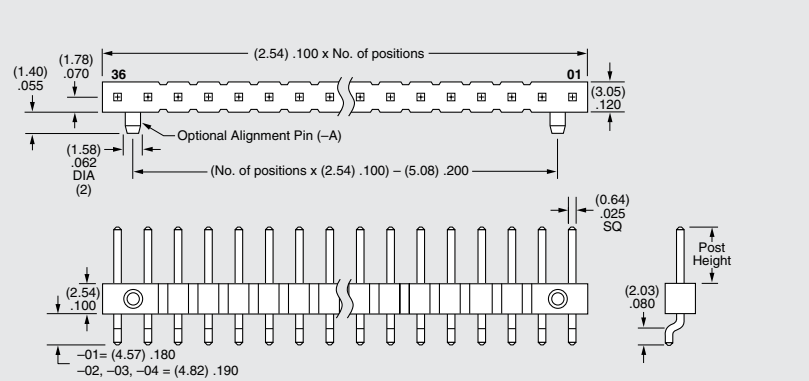

Due to technical progress, all designs, specifications and components are subject to change without notice.

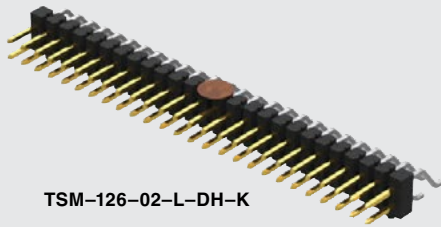

TSM-126-02-L-DH-K

TSM-115-01-T-SH-A

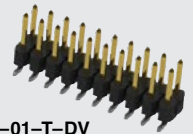
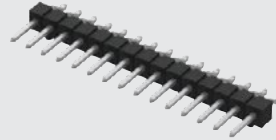

TSM-110-01-T-DV

**TSM SERIES**

**OTHER OPTIONS**

**-A**

= Alignment Pin metal or plastic at Samtec discretion (Not available with -TM or -MT) (02 positions min.) (Not available with -LC)

**-LC**

= Locking Clip (Not available with -TM) (3 positions min.) (Not available with -A) (Manual placement required)

**-K**

= (6.50 mm) .256" DIA Polyimide Film Pick & Place Pad (-SH: 4 positions minimum without -TR; 2 & 3 positions available with -TR) (-DH: 4 positions minimum without -TR)

**-“XXX”**  
= Polarized Position

**-P**

= Plastic Pick & Place Pad (-DV: 4 positions minimum without -TR; 2 & 3 positions available with -TR) (-SH: 4 positions minimum without -TR; 2 & 3 positions available with -TR) (-DH: 5 positions minimum without -TR) (-SV: 4 positions minimum without -TR; 2 & 3 positions available with -TR)

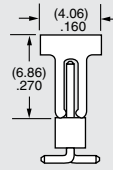

**-SV**

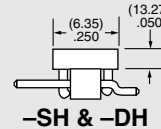

**-SH & -DH**

**-TR**

= Tape & Reel Packaging (-SV: 02-22 positions, -DV: 02-28 positions, -SH: 02-30 positions, -DH: 02-29 positions) (Not available with -MT or -TM)

**-FR**

= Full Reel Tape & Reel (must order maximum quantity per reel; contact Samtec for quantity breaks) (-SV: 02-22 positions, -DV: 02-28 positions, -SH: 02-30 positions, -DH: 02-29 positions) (Not available with -MT or -TM)

**-DV**

= Double Row Vertical Pin

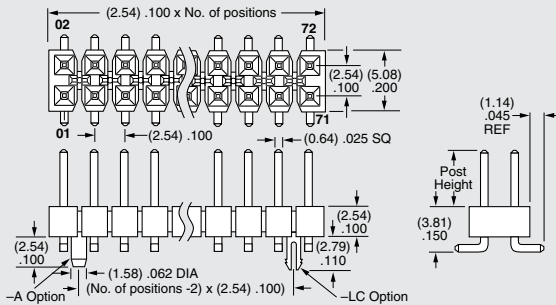

**-TM**

= Triple Row Vertical Mixed Technology (Style -01 only)

02 thru 30 positions only

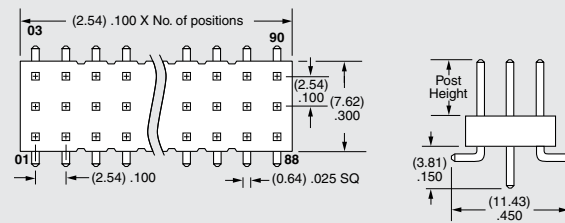

**-DH**

= Double Row Horizontal Pin (Style -01, -02 or -03 only)

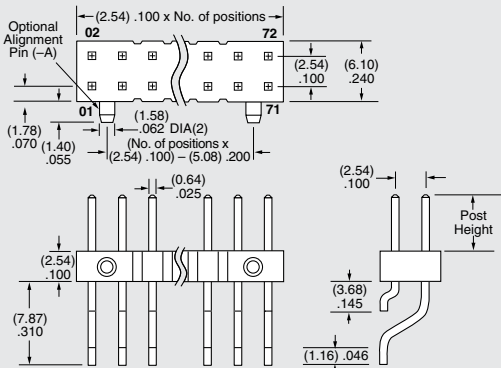

**-MT**

= Mixed Technology Pin (Style -01, -02 or -03 only)

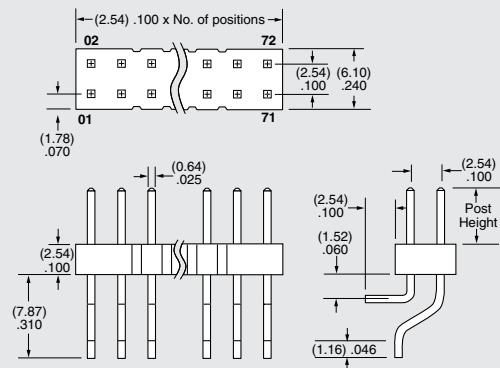

Due to technical progress, all designs, specifications and components are subject to change without notice.

[WWW.SAMTEC.COM](http://WWW.SAMTEC.COM)

All parts within this catalog are built to Samtec's specifications. Customer specific requirements must be approved by Samtec and identified in a Samtec customer-specific drawing to apply.

# Mouser Electronics

Authorized Distributor

Click to View Pricing, Inventory, Delivery & Lifecycle Information:

[Samtec:](#)

[TSM-106-01-F-SH](#)