

NSR0340HT1G

Schottky Barrier Diode

Schottky barrier diodes are optimized for very low forward voltage drop and low leakage current and are used in a wide range of dc–dc converter, clamping and protection applications in portable devices. NSR0340H in a SOD–323 miniature package enables designers to meet the challenging task of achieving higher efficiency and meeting reduced space requirements.

Features

- Very Low Forward Voltage Drop –415 mV @ 100 mA
- Low Reverse Current – 0.4 μ A @ 25 V V_R
- 250 mA of Continuous Forward Current
- Power Dissipation of 160 mW with Minimum Trace
- Very High Switching Speed
- Low Capacitance – $C_T = 6$ pF
- NSV Prefix for Automotive and Other Applications Requiring Unique Site and Control Change Requirements; AEC–Q101 Qualified and PPAP Capable
- These Devices are Pb–Free, Halogen Free/BFR Free and are RoHS Compliant

Typical Applications

- LCD and Keypad Backlighting
- Camera Photo Flash
- Buck and Boost dc–dc Converters
- Reverse Voltage and Current Protection
- Clamping & Protection

Markets

- Mobile Handsets
- MP3 Players
- Digital Camera and Camcorders
- Notebook PCs and PDAs
- GPS

MAXIMUM RATINGS

Rating	Symbol	Value	Unit
Reverse Voltage	V_R	40	Vdc
Forward Continuous Current (DC)	I_F	250	mA
Non–Repetitive Peak Forward Surge Current	I_{FSM}	1.0	A
ESD Rating: Human Body Model Machine Model	ESD	Class 2 Class A	

Stresses exceeding those listed in the Maximum Ratings table may damage the device. If any of these limits are exceeded, device functionality should not be assumed, damage may occur and reliability may be affected.



ON Semiconductor®

<http://onsemi.com>

40 VOLT SCHOTTKY BARRIER DIODE

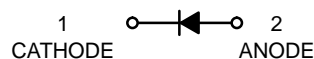

SOD–323
CASE 477
STYLE 1

MARKING DIAGRAM



AD = Specific Device Code

M = Date Code

▪ = Pb–Free Package

(Note: Microdot may be in either location)

ORDERING INFORMATION

Device	Package	Shipping†
NSR0340HT1G	SOD–323 (Pb–Free)	3000 / Tape & Reel
NSVR0340HT1G	SOD–323 (Pb–Free)	3000 / Tape & Reel

†For information on tape and reel specifications, including part orientation and tape sizes, please refer to our Tape and Reel Packaging Specifications Brochure, BRD8011/D.

NSR0340HT1G

THERMAL CHARACTERISTICS

Characteristic	Symbol	Max	Unit
Thermal Resistance Junction-to-Ambient (Note 1) Total Power Dissipation @ $T_A = 25^\circ\text{C}$	$R_{\theta JA}$ P_D	740 160	$^\circ\text{C/W}$ mW
Thermal Resistance Junction-to-Ambient (Note 2) Total Power Dissipation @ $T_A = 25^\circ\text{C}$	$R_{\theta JA}$ P_D	460 270	$^\circ\text{C/W}$ mW
Junction and Storage Temperature Range	T_J, T_{stg}	-55 to +150	$^\circ\text{C}$

1. Mounted onto a 4 in square FR-4 board 10 mm sq. 1 oz. Cu 0.06" thick single-sided. Operating to steady state.
2. Mounted onto a 4 in square FR-4 board 1 in sq. 1 oz. Cu 0.06" thick single-sided. Operating to steady state.

ELECTRICAL CHARACTERISTICS ($T_A = 25^\circ\text{C}$ unless otherwise noted)

Characteristic	Symbol	Min	Typ	Max	Unit
Reverse Leakage ($V_R = 10\text{ V}$) ($V_R = 25\text{ V}$) ($V_R = 40\text{ V}$)	I_R		0.2 0.4 1.3	1.0 3.0 6.0	μA
Forward Voltage ($I_F = 10\text{ mA}$) ($I_F = 100\text{ mA}$) ($I_F = 200\text{ mA}$)	V_F		320 415 470	350 490 590	mV
Total Capacitance ($V_R = 10\text{ V}, f = 1\text{ MHz}$)	CT		6.0		pF
Reverse Recovery Time ($I_F = I_R = 10\text{ mA}, I_R = 1.0\text{ mA}$)	t_{rr}		5.0		ns

Product parametric performance is indicated in the Electrical Characteristics for the listed test conditions, unless otherwise noted. Product performance may not be indicated by the Electrical Characteristics if operated under different conditions.

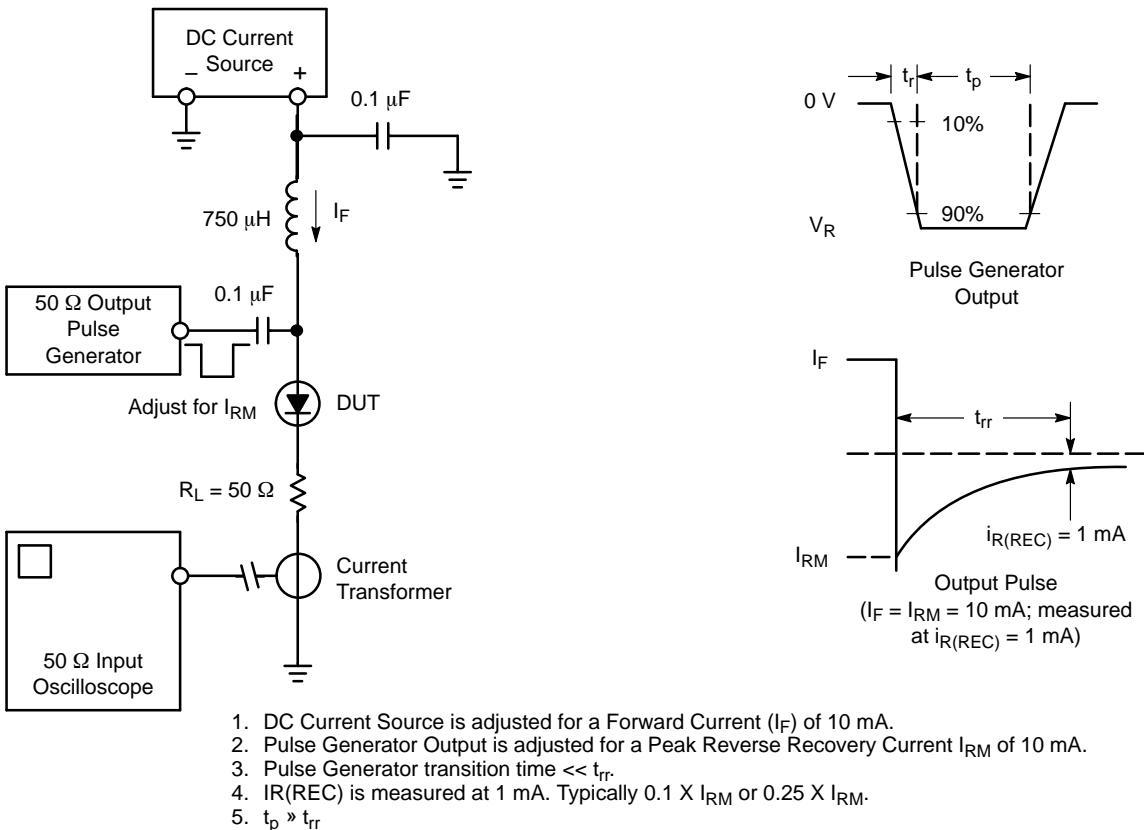

Figure 1. Recovery Time Equivalent Test Circuit

NSR0340HT1G

TYPICAL CHARACTERISTICS

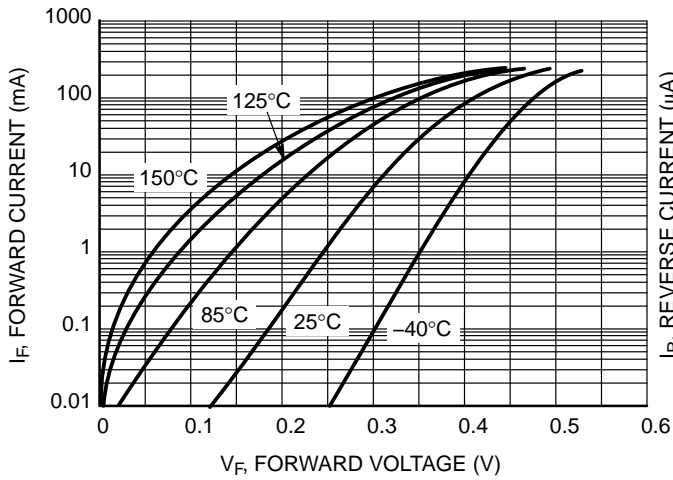

Figure 2. Forward Voltage

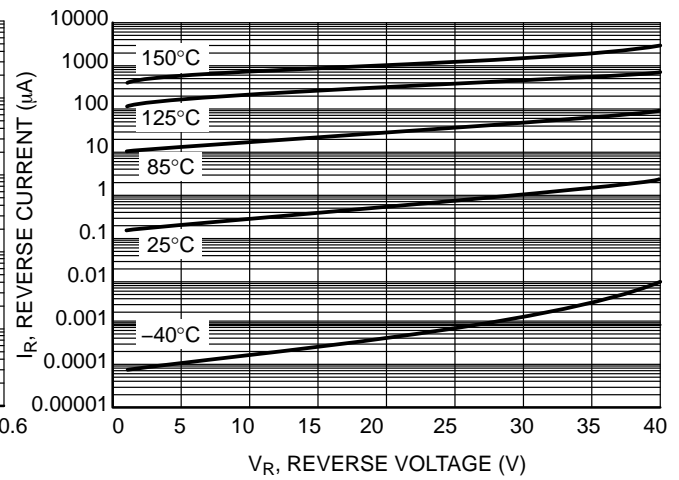

Figure 3. Leakage Current

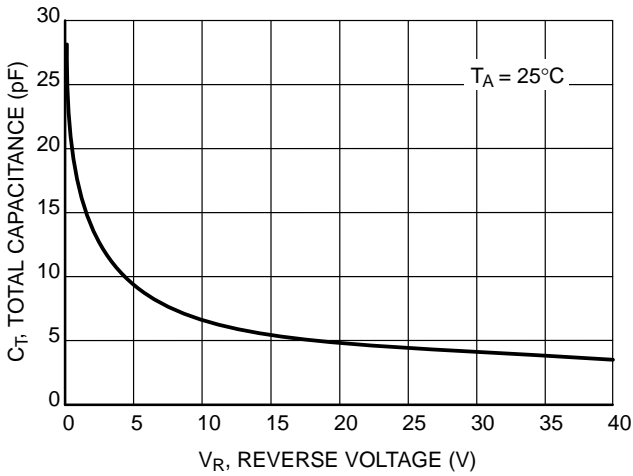

Figure 4. Total Capacitance

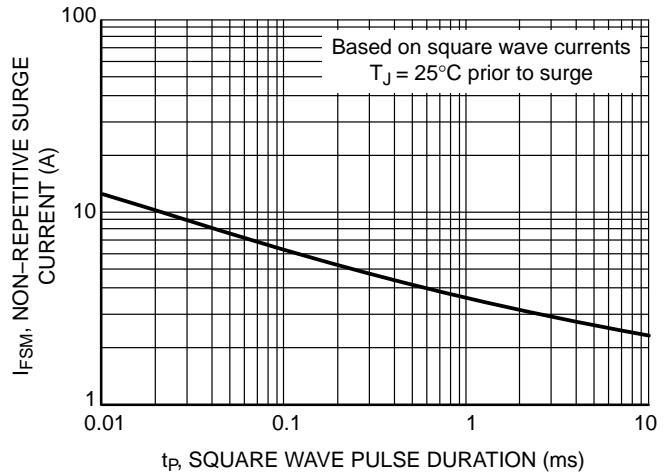

Figure 5. Non-Repetitive Surge Current

MECHANICAL CASE OUTLINE

PACKAGE DIMENSIONS

ON Semiconductor®



SOD-323
CASE 477-02
ISSUE H

DATE 13 MAR 2007

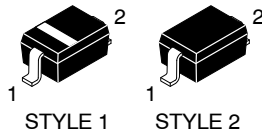

SCALE 4:1

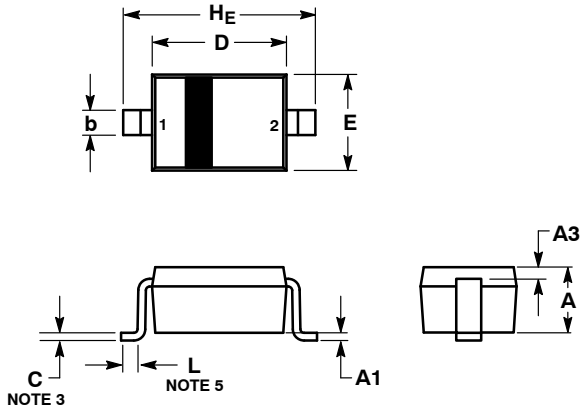

NOTES:

1. DIMENSIONING AND TOLERANCING PER ANSI Y14.5M, 1982.
2. CONTROLLING DIMENSION: MILLIMETERS.
3. LEAD THICKNESS SPECIFIED PER L/F DRAWING WITH SOLDER PLATING.
4. DIMENSIONS A AND B DO NOT INCLUDE MOLD FLASH, PROTRUSIONS OR GATE BURRS.
5. DIMENSION L IS MEASURED FROM END OF RADIUS.

DIM	MILLIMETERS			INCHES		
	MIN	NOM	MAX	MIN	NOM	MAX
A	0.80	0.90	1.00	0.031	0.035	0.040
A1	0.00	0.05	0.10	0.000	0.002	0.004
A3	0.15 REF			0.006 REF		
b	0.25	0.32	0.4	0.010	0.012	0.016
C	0.089	0.12	0.177	0.003	0.005	0.007
D	1.60	1.70	1.80	0.062	0.066	0.070
E	1.15	1.25	1.35	0.045	0.049	0.053
L	0.08			0.003		
HE	2.30	2.50	2.70	0.090	0.098	0.105

GENERIC MARKING DIAGRAM*

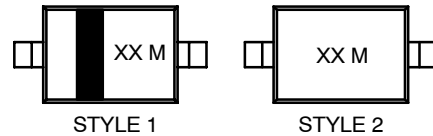

XX = Specific Device Code
M = Date Code

*This information is generic. Please refer to device data sheet for actual part marking. Pb-Free indicator, "G" or microdot "▪", may or may not be present.

SOLDERING FOOTPRINT*

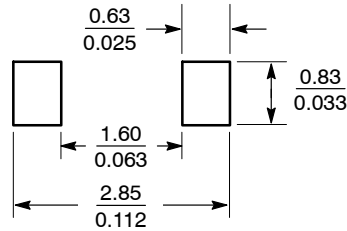

*For additional information on our Pb-Free strategy and soldering details, please download the ON Semiconductor Soldering and Mounting Techniques Reference Manual, SOLDERRM/D.

STYLE 1:
PIN 1. CATHODE (POLARITY BAND)
2. ANODE

STYLE 2:
NO POLARITY

DOCUMENT NUMBER:	98ASB17533C	Electronic versions are uncontrolled except when accessed directly from the Document Repository. Printed versions are uncontrolled except when stamped "CONTROLLED COPY" in red.
DESCRIPTION:	SOD-323	PAGE 1 OF 1

ON Semiconductor and ON are trademarks of Semiconductor Components Industries, LLC dba ON Semiconductor or its subsidiaries in the United States and/or other countries. ON Semiconductor reserves the right to make changes without further notice to any products herein. ON Semiconductor makes no warranty, representation or guarantee regarding the suitability of its products for any particular purpose, nor does ON Semiconductor assume any liability arising out of the application or use of any product or circuit, and specifically disclaims any and all liability, including without limitation special, consequential or incidental damages. ON Semiconductor does not convey any license under its patent rights nor the rights of others.

ON Semiconductor and  are trademarks of Semiconductor Components Industries, LLC dba ON Semiconductor or its subsidiaries in the United States and/or other countries. ON Semiconductor owns the rights to a number of patents, trademarks, copyrights, trade secrets, and other intellectual property. A listing of ON Semiconductor's product/patent coverage may be accessed at www.onsemi.com/site/pdf/Patent-Marking.pdf. ON Semiconductor reserves the right to make changes without further notice to any products herein. ON Semiconductor makes no warranty, representation or guarantee regarding the suitability of its products for any particular purpose, nor does ON Semiconductor assume any liability arising out of the application or use of any product or circuit, and specifically disclaims any and all liability, including without limitation special, consequential or incidental damages. Buyer is responsible for its products and applications using ON Semiconductor products, including compliance with all laws, regulations and safety requirements or standards, regardless of any support or applications information provided by ON Semiconductor. "Typical" parameters which may be provided in ON Semiconductor data sheets and/or specifications can and do vary in different applications and actual performance may vary over time. All operating parameters, including "Typicals" must be validated for each customer application by customer's technical experts. ON Semiconductor does not convey any license under its patent rights nor the rights of others. ON Semiconductor products are not designed, intended, or authorized for use as a critical component in life support systems or any FDA Class 3 medical devices or medical devices with a same or similar classification in a foreign jurisdiction or any devices intended for implantation in the human body. Should Buyer purchase or use ON Semiconductor products for any such unintended or unauthorized application, Buyer shall indemnify and hold ON Semiconductor and its officers, employees, subsidiaries, affiliates, and distributors harmless against all claims, costs, damages, and expenses, and reasonable attorney fees arising out of, directly or indirectly, any claim of personal injury or death associated with such unintended or unauthorized use, even if such claim alleges that ON Semiconductor was negligent regarding the design or manufacture of the part. ON Semiconductor is an Equal Opportunity/Affirmative Action Employer. This literature is subject to all applicable copyright laws and is not for resale in any manner.

PUBLICATION ORDERING INFORMATION

LITERATURE FULFILLMENT:

Email Requests to: orderlit@onsemi.com

ON Semiconductor Website: www.onsemi.com

TECHNICAL SUPPORT

North American Technical Support:
Voice Mail: 1 800-282-9855 Toll Free USA/Canada
Phone: 011 421 33 790 2910

Europe, Middle East and Africa Technical Support:

Phone: 00421 33 790 2910

For additional information, please contact your local Sales Representative

Mouser Electronics

Authorized Distributor

Click to View Pricing, Inventory, Delivery & Lifecycle Information:

[ON Semiconductor:](#)

[NSR0340HT1G](#) [NSVR0340HT1G](#)