

SPECIFICATION

SPEC. No. H-General-b

D A T E : 2014 May

To

Non-Controlled Copy

CUSTOMER'S PRODUCT NAME

TDK PRODUCT NAME

MULTILAYER CERAMIC CHIP CAPACITORS
CGJ Series / High Reliability Grade
General (Up to 50V)
Mid voltage (100 to 630V)

Please return this specification to TDK representatives.

If orders are placed without returned specification, please allow us to judge that specification is accepted by your side.

RECEIPT CONFIRMATION

DATE: YEAR MONTH DAY

TDK Corporation
Sales
Electronic Components
Sales & Marketing Group

TDK-EPC Corporation
Engineering
Ceramic Capacitors Business Group

APPROVED	Person in charge

APPROVED	CHECKED	Person in charge

1. SCOPE

This specification is applicable to chip type multilayer ceramic capacitors with a priority over the other relevant specification.

Manufacturing places defined in this specification shall be TDK-EPC Corporation Japan, and TDK Components USA, Inc.

TDK's CGJ Series MLCC provides an extended life MLCC that meets electrical, mechanical and environmental performance standards from AEC Q200 Rev.D.

Details are referenced within section 7 of this specification.

In addition to our highest quality MLCC, the customer will also receive access to an on-line Sigma Report and internet based product authentication for each lot (which includes electrical characterization data, and estimated product life, as well as anti-counterfeit packaging).

Additionally RFID (radio frequency identification) tags are available as an option.

EXPLANATORY NOTE:

This specification warrant the quality of the ceramic chip capacitor. The chips should be evaluated or confirmed a state of mounted on your product.

If the use of the chips go beyond the bounds of this specification, we can not afford to guarantee.

2. CODE CONSTRUCTION

(Example)

Catalog Number :	<u>CGJ2</u>	<u>B</u>	<u>2</u>	<u>X7R</u>	<u>1 C</u>	<u>104</u>	<u>K</u>	<u>050</u>	<u>B</u>	<u>A</u>
(Web)	(1)	(2)	(3)	(4)	(5)	(6)	(7)	(8)	(9)	(10)
Item Description :	<u>CGJ2</u>	<u>B</u>	<u>2</u>	<u>X7R</u>	<u>1 C</u>	<u>104</u>	<u>K</u>	<u>T</u>	<u>xxxx</u>	
	(1)	(2)	(3)	(4)	(5)	(6)	(7)	(11)	(12)	

(1) Type

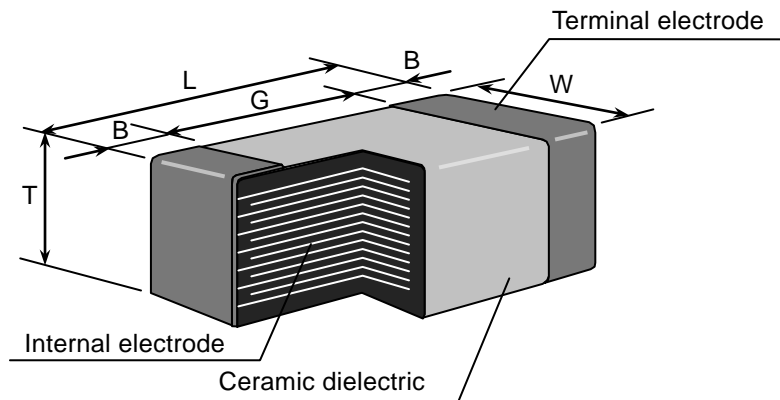

Please refer to product list on the web catalog, for the dimension of each product.

(2) Thickness

* As for dimension tolerance, please contact with our sales representative.

Thickness	Dimension (mm)
B	0.50
C	0.60
E	0.80
F	0.85
H	1.15
J	1.25
K	1.30
L	1.60
M	2.00
N	2.30
P	2.50

- (3) Guaranteed life test condition
 (Details are shown in 7.PERFORMANCE No.21)

Sign	Condition
1	Rated Voltage x 1
2	Rated Voltage x 2
3	Rated Voltage x 1.5
4	Rated Voltage x 1.2

- (4) Temperature Characteristics (Details are shown in 7.PREFORMANCE No.8, 9)

- (5) Rated Voltage

Symbol	Rated Voltage
2 H	DC 500 V
2 D	DC 200 V
2 A	DC 100 V
1 H	DC 50 V
1 E	DC 25 V
1 C	DC 16 V
1 A	DC 10 V
0 J	DC 6.3 V

- (6) Rated Capacitance

Stated in three digits and in units of pico farads (pF).

The first and Second digits identify the first and second significant figures of the capacitance, the third digit identifies the multiplier.

R is designated for a decimal point.

Example 104 → 100,000pF

- (7) Capacitance tolerance

Symbol	Tolerance
J	± 5 %
K	± 10 %
M	± 20 %

- (8) Thickness code (Only Catalog Number)

- (9) Package code (Only Catalog Number)

- (10) Special code (Only Catalog Number)

- (11) Packaging (Only Item Description)

Symbol	Packaging
T	Taping

- (12) Internal code (Only Item Description)

3. RATED CAPACITANCE AND TOLERANCE

3.1 Standard combination of rated capacitance and tolerances

Class	Temperature Characteristics	Capacitance tolerance		Rated capacitance
1	C0G	10pF and under	C ($\pm 0.25\text{pF}$)	1, 1.5, 2, 2.2, 3, 3.3, 4, 4.7, 5
			D ($\pm 0.5\text{pF}$)	6, 6.8, 7, 8, 9, 10
		12pF to 10,000pF	J ($\pm 5\%$) K ($\pm 10\%$)	E – 12 series
			J ($\pm 5\%$) K ($\pm 10\%$)	E – 6 series
2	X7R X7S X7T	K ($\pm 10\%$) M ($\pm 20\%$)	E – 6 series	

3.2 Capacitance Step in E series

E series	Capacitance Step											
E-6	1.0		1.5		2.2		3.3		4.7		6.8	
E-12	1.0	1.2	1.5	1.8	2.2	2.7	3.3	3.9	4.7	5.6	6.8	8.2

4. OPERATING TEMPERATURE RANGE

T.C.	Min. operating Temperature	Max. operating Temperature	Reference Temperature
C0G X7R X7S X7T	-55°C	125°C	25°C

5. STORING CONDITION AND TERM

5 to 40°C at 20 to 70%RH
6 months Max.

6. ENVIRONMENTAL ISSUE

(1) Environmental Conscious Product

This product does not use chemical substances whose use is restricted by the RoHS Directive of End of Life Vehicle (ELV) Directive.

TDK's MLCC capacitors are lead free and conform to the RoHS and REACH directives.

TDK's MLCC do not contain any listed or banned substances nor does TDK use any of the banned substances listed during manufacturing.

(2) INDUSTRIAL WASTE DISPOSAL

Dispose this product as industrial waste in accordance with local industrial waste law.

7. PERFORMANCE

table 1

No.	Item	Performance	Test or inspection method																				
1	External Appearance	No defects which may affect performance.	Inspect with magnifying glass (3×).																				
2	Destructive Physical Analysis	No defects or abnormalities.	Per EIA-469																				
3	Insulation Resistance	10,000MΩ or 500MΩ·μF min. (As for the capacitors of rated voltage 16V DC and the item below, 10,000 MΩ or 100MΩ·μF min.,) whichever smaller.	Apply rated voltage for 60s.																				
4	Voltage Proof	Withstand test voltage without insulation breakdown or other damage.	<table border="1"> <thead> <tr> <th>Class</th> <th>Rated voltage</th> <th>Apply voltage</th> </tr> </thead> <tbody> <tr> <td rowspan="2">Class1</td> <td>100V and under</td> <td>3 × rated voltage</td> </tr> <tr> <td>Over 100V</td> <td>1.5 × rated voltage</td> </tr> <tr> <td rowspan="2">Class2</td> <td>100V and under</td> <td>2.5 × rated voltage</td> </tr> <tr> <td>Over 100V</td> <td>1.5 × rated voltage</td> </tr> </tbody> </table> <p>Above DC voltage shall be applied for 1 to 5s. Charge / discharge current shall not exceed 50mA.</p>	Class	Rated voltage	Apply voltage	Class1	100V and under	3 × rated voltage	Over 100V	1.5 × rated voltage	Class2	100V and under	2.5 × rated voltage	Over 100V	1.5 × rated voltage							
Class	Rated voltage	Apply voltage																					
Class1	100V and under	3 × rated voltage																					
	Over 100V	1.5 × rated voltage																					
Class2	100V and under	2.5 × rated voltage																					
	Over 100V	1.5 × rated voltage																					
5	Capacitance	Within the specified tolerance.	<table border="1"> <thead> <tr> <th>Class</th> <th>Capacitance</th> <th>Measuring frequency</th> <th>Measuring voltage</th> </tr> </thead> <tbody> <tr> <td rowspan="2">Class1</td> <td>1000pF and under</td> <td>1MHz±10%</td> <td rowspan="2">0.5 - 5 Vrms.</td> </tr> <tr> <td>Over 1000pF</td> <td>1kHz±10%</td> </tr> <tr> <td rowspan="2">Class2</td> <td>10uF and under</td> <td>1kHz±10%</td> <td>0.5±0.2Vrms</td> </tr> <tr> <td>Over 10uF</td> <td>120Hz±20%</td> <td>1.0±0.2Vrms</td> </tr> </tbody> </table> <p>For information which product has which measuring voltage, please contact with our sales representative.</p>	Class	Capacitance	Measuring frequency	Measuring voltage	Class1	1000pF and under	1MHz±10%	0.5 - 5 Vrms.	Over 1000pF	1kHz±10%	Class2	10uF and under	1kHz±10%	0.5±0.2Vrms	Over 10uF	120Hz±20%	1.0±0.2Vrms			
Class	Capacitance	Measuring frequency	Measuring voltage																				
Class1	1000pF and under	1MHz±10%	0.5 - 5 Vrms.																				
	Over 1000pF	1kHz±10%																					
Class2	10uF and under	1kHz±10%	0.5±0.2Vrms																				
	Over 10uF	120Hz±20%	1.0±0.2Vrms																				
6	Q (Class1)	<table border="1"> <thead> <tr> <th>Capacitance</th> <th>Q</th> </tr> </thead> <tbody> <tr> <td>30pF and over</td> <td>1,000 min.</td> </tr> <tr> <td>Under 30pF</td> <td>400+20xC min.</td> </tr> </tbody> </table> <p>C : Rated capacitance (pF)</p>	Capacitance	Q	30pF and over	1,000 min.	Under 30pF	400+20xC min.	See No.5 in this table for measuring condition.														
Capacitance	Q																						
30pF and over	1,000 min.																						
Under 30pF	400+20xC min.																						
7	Dissipation Factor (Class2)	0.025 max. 0.03 max. 0.05 max. 0.075 max. For information which product has which Dissipation Factor, please contact with our sales representative.	See No.5 in this table for measuring condition.																				
8	Temperature Characteristics of Capacitance (Class1)	<table border="1"> <thead> <tr> <th>T.C.</th> <th>Temperature Coefficient</th> </tr> </thead> <tbody> <tr> <td>COG</td> <td>0 ± 30 (ppm/°C)</td> </tr> </tbody> </table> <p>Capacitance drift within ± 0.2% or ± 0.05pF, whichever larger.</p>	T.C.	Temperature Coefficient	COG	0 ± 30 (ppm/°C)	<p>Temperature Coefficient shall be calculated based on values at 25°C and 125°C temperature. The capacitance should be within the tolerance below.</p> <table border="1"> <thead> <tr> <th colspan="4">Capacitance change from 25°C (%)</th> </tr> <tr> <th colspan="2">-55°C</th> <th colspan="2">125°C</th> </tr> <tr> <th>Max.</th> <th>Min.</th> <th>Max.</th> <th>Min.</th> </tr> </thead> <tbody> <tr> <td>0.58</td> <td>-0.24</td> <td>0.30</td> <td>-0.30</td> </tr> </tbody> </table>	Capacitance change from 25°C (%)				-55°C		125°C		Max.	Min.	Max.	Min.	0.58	-0.24	0.30	-0.30
T.C.	Temperature Coefficient																						
COG	0 ± 30 (ppm/°C)																						
Capacitance change from 25°C (%)																							
-55°C		125°C																					
Max.	Min.	Max.	Min.																				
0.58	-0.24	0.30	-0.30																				

(continued)

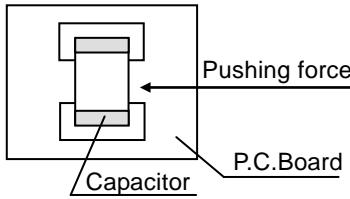
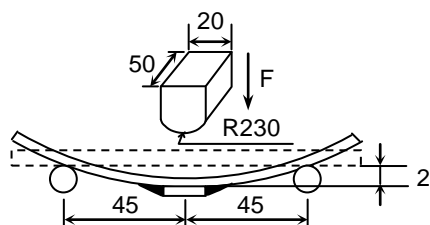
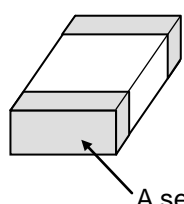
No.	Item	Performance	Test or inspection method										
9	Temperature Characteristics of Capacitance (Class2)	<p style="text-align: center;"><u>Capacitance Change (%)</u></p> <p style="text-align: center;"><u>No voltage applied</u></p> <p style="text-align: center;">X7R : ± 15</p> <p style="text-align: center;">X7S : ± 22</p> <p style="text-align: center;">X7T : +22 -33</p>	<p>Capacitance shall be measured by the steps shown in the following table after thermal equilibrium is obtained for each step.</p> <p>ΔC be calculated ref. STEP3 reading</p> <table border="1" style="width: 100%; border-collapse: collapse;"> <thead> <tr> <th style="width: 20%;">Step</th> <th style="width: 80%;">Temperature(°C)</th> </tr> </thead> <tbody> <tr> <td style="text-align: center;">1</td> <td style="text-align: center;">Reference temp. ± 2</td> </tr> <tr> <td style="text-align: center;">2</td> <td style="text-align: center;">Min. operating temp. ± 2</td> </tr> <tr> <td style="text-align: center;">3</td> <td style="text-align: center;">Reference temp. ± 2</td> </tr> <tr> <td style="text-align: center;">4</td> <td style="text-align: center;">Max. operating temp. ± 2</td> </tr> </tbody> </table> <p>Measuring voltage : 0.1, 0.2, 0.5, 1.0Vrms. For information which product has which Measuring voltage, please contact with our sales representative.</p>	Step	Temperature(°C)	1	Reference temp. ± 2	2	Min. operating temp. ± 2	3	Reference temp. ± 2	4	Max. operating temp. ± 2
Step	Temperature(°C)												
1	Reference temp. ± 2												
2	Min. operating temp. ± 2												
3	Reference temp. ± 2												
4	Max. operating temp. ± 2												
10	Robustness of Terminations	No sign of termination coming off, breakage of ceramic, or other abnormal signs.	<p>Reflow solder the capacitors on a P.C.Board shown in Appendix 1a or Appendix 1b and apply a pushing force of 17.7N with 10±1s. (2N is applied for CGJ2 type)</p> 										
11	Bending	No mechanical damage. Capacitance change from initial value should be within 12.5% (Class2) and 5% (Class1).	<p>Reflow solder the capacitors on a P.C.Board shown in Appendix 2a or Appendix 2b and bend it for 2mm.</p>  <p style="text-align: right;">(Unit : mm)</p>										
12	Solderability	<p>New solder to cover over 95% of termination. 5% may have pin holes or rough spots but not concentrated in one spot. Ceramic surface of A sections shall not be exposed due to melting or shifting of termination material.</p> 	<p>Method a) Preheat:155°C, dry heat for 4h. Soak terminations in the solder 235°C for 5 (-0.5) sec.</p> <p>Method b) Preheat:93±3°C, steam aging for 8h. Soak terminations in the solder 215°C for 5 (-0.5) sec.</p> <p>Method c) Preheat:93±3°C, steam aging for 8h. Soak terminations in the solder 260°C for 7 ± 0.5 sec.</p>										

(continued)

No.	Item		Performance	Test or inspection method										
13	Resistance to solder heat	External appearance	No cracks are allowed and terminations shall be covered at least 60% with new solder.	<p>Completely soak both terminations in solder at 260±5°C for 10±1s.</p> <p>Preheating condition Temp. : 150±10°C Time : 1 to 2min.</p> <p>Flux : Isopropyl alcohol (JIS K 8839) Rosin (JIS K 5902) 25% solid solution.</p> <p>Solder : H63A (JIS Z 3282)</p> <p>Leave the capacitors in ambient condition for 6 to 24h (Class1) or 24±2h (Class2) before measurement.</p>										
		Capacitance	<table border="1"> <thead> <tr> <th colspan="2">Characteristics</th> <th>Change from the value before test</th> </tr> </thead> <tbody> <tr> <td>Class1</td> <td>C0G</td> <td>Capacitance drift within ± 2.5% or ± 0.25pF, whichever larger.</td> </tr> <tr> <td>Class2</td> <td>X7R X7S X7T</td> <td>± 7.5 %</td> </tr> </tbody> </table>		Characteristics		Change from the value before test	Class1	C0G	Capacitance drift within ± 2.5% or ± 0.25pF, whichever larger.	Class2	X7R X7S X7T	± 7.5 %	
			Characteristics		Change from the value before test									
			Class1		C0G	Capacitance drift within ± 2.5% or ± 0.25pF, whichever larger.								
		Class2	X7R X7S X7T		± 7.5 %									
		Q (Class1)	Capacitance		Q									
30pF and over	1,000 min.													
D.F. (Class2)	Under 30pF	400+20×C min.												
	C : Rated capacitance (pF)													
Insulation Resistance	Meet the initial spec.													
Voltage proof	No insulation breakdown or other damage.													
14	Vibration	External appearance	No mechanical damage.	<p>Reflow solder the capacitors on a P.C.Board shown in Appendix 1a or Appendix 1b before testing.</p> <p>Vibrate the capacitor with following conditions.</p> <p>Applied force : 5G max. Frequency : 10-2000Hz Duration : 20 min. Cycle : 12 cycles</p>										
		Capacitance	<table border="1"> <thead> <tr> <th colspan="2">Characteristics</th> <th>Change from the value before test</th> </tr> </thead> <tbody> <tr> <td>Class1</td> <td>C0G</td> <td>Capacitance drift within ± 2.5% or ± 0.25pF, whichever larger.</td> </tr> <tr> <td>Class2</td> <td>X7R X7S X7T</td> <td>± 7.5 %</td> </tr> </tbody> </table>		Characteristics		Change from the value before test	Class1	C0G	Capacitance drift within ± 2.5% or ± 0.25pF, whichever larger.	Class2	X7R X7S X7T	± 7.5 %	
			Characteristics		Change from the value before test									
			Class1		C0G	Capacitance drift within ± 2.5% or ± 0.25pF, whichever larger.								
Class2	X7R X7S X7T	± 7.5 %												
Q (Class1)	Capacitance	Q												
	30pF and over	1,000 min.												
D.F. (Class2)	Under 30pF	400+20×C min.												
	C : Rated capacitance (pF)													
D.F. (Class2)		Meet the initial spec.												

(continued)

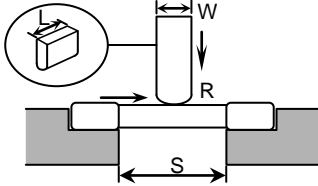
No.	Item	Performance	Test or inspection method																														
15	<table border="1"> <tr> <td data-bbox="193 197 352 264">Mechanical Shock</td> <td data-bbox="352 197 523 264">External appearance</td> <td data-bbox="523 197 967 264">No mechanical damage.</td> <td data-bbox="967 197 1482 891" rowspan="5"> Apply three shocks along 3 mutually Perpendicular axes of the capacitors. (18 shocks) Test pulse : Half-sine Duration : 0.5m Force Peak : 1500G Velocity change : 4.7m/s </td> </tr> <tr> <td></td> <td data-bbox="352 264 523 568">Capacitance</td> <td data-bbox="523 264 967 568"> <table border="1"> <tr> <td colspan="2" data-bbox="523 264 719 353">Characteristics</td> <td data-bbox="719 264 967 353">Change from the value before test</td> </tr> <tr> <td data-bbox="523 353 651 472">Class1</td> <td data-bbox="651 353 719 472">C0G</td> <td data-bbox="719 353 967 472">Capacitance drift within $\pm 2.5\%$ or $\pm 0.25\text{pF}$, whichever larger.</td> </tr> <tr> <td data-bbox="523 472 651 568">Class2</td> <td data-bbox="651 472 719 568">X7R X7S X7T</td> <td data-bbox="719 472 967 568">$\pm 7.5\%$</td> </tr> </table> </td> </tr> <tr> <td></td> <td data-bbox="352 568 523 763">Q (Class1)</td> <td data-bbox="523 568 967 763"> <table border="1"> <tr> <td data-bbox="523 568 719 645">Capacitance</td> <td data-bbox="719 568 967 645">Q</td> </tr> <tr> <td data-bbox="523 645 719 689">30pF and over</td> <td data-bbox="719 645 967 689">1,000 min.</td> </tr> <tr> <td data-bbox="523 689 719 763">Under 30pF</td> <td data-bbox="719 689 967 763">400+20xC min.</td> </tr> </table> C : Rated capacitance (pF) </td> </tr> <tr> <td></td> <td data-bbox="352 763 523 831">D.F. (Class2)</td> <td data-bbox="523 763 967 831">Meet the initial spec.</td> </tr> <tr> <td></td> <td data-bbox="352 831 523 891">Insulation Resistance</td> <td data-bbox="523 831 967 891">Meet the initial spec.</td> </tr> </table>	Mechanical Shock	External appearance	No mechanical damage.	Apply three shocks along 3 mutually Perpendicular axes of the capacitors. (18 shocks) Test pulse : Half-sine Duration : 0.5m Force Peak : 1500G Velocity change : 4.7m/s		Capacitance	<table border="1"> <tr> <td colspan="2" data-bbox="523 264 719 353">Characteristics</td> <td data-bbox="719 264 967 353">Change from the value before test</td> </tr> <tr> <td data-bbox="523 353 651 472">Class1</td> <td data-bbox="651 353 719 472">C0G</td> <td data-bbox="719 353 967 472">Capacitance drift within $\pm 2.5\%$ or $\pm 0.25\text{pF}$, whichever larger.</td> </tr> <tr> <td data-bbox="523 472 651 568">Class2</td> <td data-bbox="651 472 719 568">X7R X7S X7T</td> <td data-bbox="719 472 967 568">$\pm 7.5\%$</td> </tr> </table>	Characteristics		Change from the value before test	Class1	C0G	Capacitance drift within $\pm 2.5\%$ or $\pm 0.25\text{pF}$, whichever larger.	Class2	X7R X7S X7T	$\pm 7.5\%$		Q (Class1)	<table border="1"> <tr> <td data-bbox="523 568 719 645">Capacitance</td> <td data-bbox="719 568 967 645">Q</td> </tr> <tr> <td data-bbox="523 645 719 689">30pF and over</td> <td data-bbox="719 645 967 689">1,000 min.</td> </tr> <tr> <td data-bbox="523 689 719 763">Under 30pF</td> <td data-bbox="719 689 967 763">400+20xC min.</td> </tr> </table> C : Rated capacitance (pF)	Capacitance	Q	30pF and over	1,000 min.	Under 30pF	400+20xC min.		D.F. (Class2)	Meet the initial spec.		Insulation Resistance	Meet the initial spec.	
Mechanical Shock	External appearance	No mechanical damage.	Apply three shocks along 3 mutually Perpendicular axes of the capacitors. (18 shocks) Test pulse : Half-sine Duration : 0.5m Force Peak : 1500G Velocity change : 4.7m/s																														
	Capacitance	<table border="1"> <tr> <td colspan="2" data-bbox="523 264 719 353">Characteristics</td> <td data-bbox="719 264 967 353">Change from the value before test</td> </tr> <tr> <td data-bbox="523 353 651 472">Class1</td> <td data-bbox="651 353 719 472">C0G</td> <td data-bbox="719 353 967 472">Capacitance drift within $\pm 2.5\%$ or $\pm 0.25\text{pF}$, whichever larger.</td> </tr> <tr> <td data-bbox="523 472 651 568">Class2</td> <td data-bbox="651 472 719 568">X7R X7S X7T</td> <td data-bbox="719 472 967 568">$\pm 7.5\%$</td> </tr> </table>		Characteristics		Change from the value before test	Class1	C0G	Capacitance drift within $\pm 2.5\%$ or $\pm 0.25\text{pF}$, whichever larger.	Class2	X7R X7S X7T	$\pm 7.5\%$																					
Characteristics		Change from the value before test																															
Class1	C0G	Capacitance drift within $\pm 2.5\%$ or $\pm 0.25\text{pF}$, whichever larger.																															
Class2	X7R X7S X7T	$\pm 7.5\%$																															
	Q (Class1)	<table border="1"> <tr> <td data-bbox="523 568 719 645">Capacitance</td> <td data-bbox="719 568 967 645">Q</td> </tr> <tr> <td data-bbox="523 645 719 689">30pF and over</td> <td data-bbox="719 645 967 689">1,000 min.</td> </tr> <tr> <td data-bbox="523 689 719 763">Under 30pF</td> <td data-bbox="719 689 967 763">400+20xC min.</td> </tr> </table> C : Rated capacitance (pF)	Capacitance	Q	30pF and over	1,000 min.	Under 30pF	400+20xC min.																									
Capacitance	Q																																
30pF and over	1,000 min.																																
Under 30pF	400+20xC min.																																
	D.F. (Class2)	Meet the initial spec.																															
	Insulation Resistance	Meet the initial spec.																															
16	Beam Load	Breaking strength will be reported during qualification or per customer request.	Place the capacitor in the beam load fixture and apply force.  Force speed : $2.5 \pm 0.25\text{mm/s}$ Jig : R 0.5mm L 6mm W 1mm (In case $S < 1$, $W=0.75\text{mm}$) S 55% the nominal length of the component tested.																														
17	<table border="1"> <tr> <td data-bbox="193 1357 352 1424">ESD</td> <td data-bbox="352 1357 523 1424">External appearance</td> <td data-bbox="523 1357 967 1424">No mechanical damage.</td> <td data-bbox="967 1357 1482 2033" rowspan="5"> AEC-Q200-002, Human Body Model Max. ESD voltage passed will be reported during qualification or per customer request. </td> </tr> <tr> <td></td> <td data-bbox="352 1424 523 1720">Capacitance</td> <td data-bbox="523 1424 967 1720"> <table border="1"> <tr> <td colspan="2" data-bbox="523 1424 719 1514">Characteristics</td> <td data-bbox="719 1424 967 1514">Change from the value before test</td> </tr> <tr> <td data-bbox="523 1514 651 1632">Class1</td> <td data-bbox="651 1514 719 1632">C0G</td> <td data-bbox="719 1514 967 1632">Capacitance drift within $\pm 2.5\%$ or $\pm 0.25\text{pF}$, whichever larger.</td> </tr> <tr> <td data-bbox="523 1632 651 1720">Class2</td> <td data-bbox="651 1632 719 1720">X7R X7S X7T</td> <td data-bbox="719 1632 967 1720">$\pm 7.5\%$</td> </tr> </table> </td> </tr> <tr> <td></td> <td data-bbox="352 1720 523 1915">Q (Class1)</td> <td data-bbox="523 1720 967 1915"> <table border="1"> <tr> <td data-bbox="523 1720 719 1796">Capacitance</td> <td data-bbox="719 1720 967 1796">Q</td> </tr> <tr> <td data-bbox="523 1796 719 1841">30pF and over</td> <td data-bbox="719 1796 967 1841">1,000 min.</td> </tr> <tr> <td data-bbox="523 1841 719 1915">Under 30pF</td> <td data-bbox="719 1841 967 1915">400+20xC min.</td> </tr> </table> C : Rated capacitance (pF) </td> </tr> <tr> <td></td> <td data-bbox="352 1915 523 1982">D.F. (Class2)</td> <td data-bbox="523 1915 967 1982">Meet the initial spec.</td> </tr> <tr> <td></td> <td data-bbox="352 1982 523 2033">Insulation Resistance</td> <td data-bbox="523 1982 967 2033">Meet the initial spec.</td> </tr> </table>	ESD	External appearance	No mechanical damage.	AEC-Q200-002, Human Body Model Max. ESD voltage passed will be reported during qualification or per customer request.		Capacitance	<table border="1"> <tr> <td colspan="2" data-bbox="523 1424 719 1514">Characteristics</td> <td data-bbox="719 1424 967 1514">Change from the value before test</td> </tr> <tr> <td data-bbox="523 1514 651 1632">Class1</td> <td data-bbox="651 1514 719 1632">C0G</td> <td data-bbox="719 1514 967 1632">Capacitance drift within $\pm 2.5\%$ or $\pm 0.25\text{pF}$, whichever larger.</td> </tr> <tr> <td data-bbox="523 1632 651 1720">Class2</td> <td data-bbox="651 1632 719 1720">X7R X7S X7T</td> <td data-bbox="719 1632 967 1720">$\pm 7.5\%$</td> </tr> </table>	Characteristics		Change from the value before test	Class1	C0G	Capacitance drift within $\pm 2.5\%$ or $\pm 0.25\text{pF}$, whichever larger.	Class2	X7R X7S X7T	$\pm 7.5\%$		Q (Class1)	<table border="1"> <tr> <td data-bbox="523 1720 719 1796">Capacitance</td> <td data-bbox="719 1720 967 1796">Q</td> </tr> <tr> <td data-bbox="523 1796 719 1841">30pF and over</td> <td data-bbox="719 1796 967 1841">1,000 min.</td> </tr> <tr> <td data-bbox="523 1841 719 1915">Under 30pF</td> <td data-bbox="719 1841 967 1915">400+20xC min.</td> </tr> </table> C : Rated capacitance (pF)	Capacitance	Q	30pF and over	1,000 min.	Under 30pF	400+20xC min.		D.F. (Class2)	Meet the initial spec.		Insulation Resistance	Meet the initial spec.	
ESD	External appearance	No mechanical damage.	AEC-Q200-002, Human Body Model Max. ESD voltage passed will be reported during qualification or per customer request.																														
	Capacitance	<table border="1"> <tr> <td colspan="2" data-bbox="523 1424 719 1514">Characteristics</td> <td data-bbox="719 1424 967 1514">Change from the value before test</td> </tr> <tr> <td data-bbox="523 1514 651 1632">Class1</td> <td data-bbox="651 1514 719 1632">C0G</td> <td data-bbox="719 1514 967 1632">Capacitance drift within $\pm 2.5\%$ or $\pm 0.25\text{pF}$, whichever larger.</td> </tr> <tr> <td data-bbox="523 1632 651 1720">Class2</td> <td data-bbox="651 1632 719 1720">X7R X7S X7T</td> <td data-bbox="719 1632 967 1720">$\pm 7.5\%$</td> </tr> </table>		Characteristics		Change from the value before test	Class1	C0G	Capacitance drift within $\pm 2.5\%$ or $\pm 0.25\text{pF}$, whichever larger.	Class2	X7R X7S X7T	$\pm 7.5\%$																					
Characteristics		Change from the value before test																															
Class1	C0G	Capacitance drift within $\pm 2.5\%$ or $\pm 0.25\text{pF}$, whichever larger.																															
Class2	X7R X7S X7T	$\pm 7.5\%$																															
	Q (Class1)	<table border="1"> <tr> <td data-bbox="523 1720 719 1796">Capacitance</td> <td data-bbox="719 1720 967 1796">Q</td> </tr> <tr> <td data-bbox="523 1796 719 1841">30pF and over</td> <td data-bbox="719 1796 967 1841">1,000 min.</td> </tr> <tr> <td data-bbox="523 1841 719 1915">Under 30pF</td> <td data-bbox="719 1841 967 1915">400+20xC min.</td> </tr> </table> C : Rated capacitance (pF)	Capacitance	Q	30pF and over	1,000 min.	Under 30pF	400+20xC min.																									
Capacitance	Q																																
30pF and over	1,000 min.																																
Under 30pF	400+20xC min.																																
	D.F. (Class2)	Meet the initial spec.																															
	Insulation Resistance	Meet the initial spec.																															

(continued)

No.	Item	Performance	Test or inspection method															
18	High Temp. Exposure (Storage)	External appearance	No mechanical damage.															
		Capacitance	Characteristics	Change from the value before test														
			Class1	COG	Capacitance drift within $\pm 2.5\%$ or $\pm 0.25\text{pF}$, whichever larger.													
			Class2	X7R X7S X7T	$\pm 7.5\%$													
		Q (Class1)	Capacitance	Q														
			30pF and over	1,000 min.														
			Under 30pF	$400+20\times C$ min.														
C : Rated capacitance (pF)																		
D.F. (Class2)	Meet the initial spec.																	
Insulation Resistance	Meet the initial spec.																	
Voltage proof	No insulation breakdown or other damage.																	
19	Temperature cycle	External appearance	No mechanical damage.															
		Capacitance	Characteristics	Change from the value before test														
			Class1	COG	Capacitance drift within $\pm 2.5\%$ or $\pm 0.25\text{pF}$, whichever larger.													
			Class2	X7R X7S X7T	$\pm 7.5\%$													
		Q (Class1)	Capacitance	Q														
			30pF and over	1,000 min.														
			Under 30pF	$400+20\times C$ min.														
C : Rated capacitance (pF)																		
D.F. (Class2)	Meet the initial spec.																	
Insulation Resistance	Meet the initial spec.																	
Voltage proof	No insulation breakdown or other damage.																	
			<p>Reflow solder the capacitors on a P.C.Board shown in Appendix 1a or Appendix 1b before testing.</p> <p>Test condition : $125\pm 3^\circ\text{C}$ for $1,000\pm 12\text{h}$.</p> <p>Leave the capacitors in ambient condition for 6 to 24h (Class 1) or $24\pm 2\text{h}$ (Class 2) before measurement.</p>															
			<p>Reflow solder the capacitors on a P.C.Board shown in Appendix 1a or Appendix 1b before testing.</p> <p>Expose the capacitors in the condition step1 through step 4 and repeat 1000 times consecutively.</p> <p>Leave the capacitors in ambient condition for 6 to 24h (Class 1) or $24\pm 2\text{h}$ (Class 2) before measurement.</p> <table border="1"> <thead> <tr> <th>Step</th> <th>Temperature($^\circ\text{C}$)</th> <th>Time (min.)</th> </tr> </thead> <tbody> <tr> <td>1</td> <td>Min. operating temp. ± 3</td> <td>30 ± 3</td> </tr> <tr> <td>2</td> <td>Reference Temp. ± 2</td> <td>2 - 5</td> </tr> <tr> <td>3</td> <td>Max. operating temp. ± 2</td> <td>30 ± 2</td> </tr> <tr> <td>4</td> <td>Reference Temp. ± 2</td> <td>2 - 5</td> </tr> </tbody> </table>	Step	Temperature($^\circ\text{C}$)	Time (min.)	1	Min. operating temp. ± 3	30 ± 3	2	Reference Temp. ± 2	2 - 5	3	Max. operating temp. ± 2	30 ± 2	4	Reference Temp. ± 2	2 - 5
Step	Temperature($^\circ\text{C}$)	Time (min.)																
1	Min. operating temp. ± 3	30 ± 3																
2	Reference Temp. ± 2	2 - 5																
3	Max. operating temp. ± 2	30 ± 2																
4	Reference Temp. ± 2	2 - 5																

(continued)

No.	Item		Performance	Test or inspection method										
20	Biased Humidity	External appearance	No mechanical damage.	<p>Reflow solder the capacitors on a P.C.Board shown in Appendix 1a or Appendix 1b before testing.</p> <p>Apply the rated voltage at temperature 85°C and 85%RH for 1000 +24,0h.</p> <p>Charge/discharge current shall not exceed 50mA.</p> <p>Leave the capacitors in ambient condition for 6 to 24h (Class1) or 24±2h (Class2) before measurement.</p> <p>Voltage conditioning (only for class 2) Voltage treat the capacitors under testing temperature and voltage for 1 hour.</p> <p>Leave the capacitors in ambient condition for 24±2h before measurement.</p> <p>Use this measurement for initial value.</p>										
		Capacitance	<table border="1"> <thead> <tr> <th colspan="2">Characteristics</th> <th>Change from the value before test</th> </tr> </thead> <tbody> <tr> <td>Class1</td> <td>COG</td> <td>Capacitance drift within ± 7.5% or ± 0.75pF, whichever larger.</td> </tr> <tr> <td>Class2</td> <td>X7R X7S X7T</td> <td>± 12.5 %</td> </tr> </tbody> </table>		Characteristics		Change from the value before test	Class1	COG	Capacitance drift within ± 7.5% or ± 0.75pF, whichever larger.	Class2	X7R X7S X7T	± 12.5 %	
			Characteristics		Change from the value before test									
			Class1		COG	Capacitance drift within ± 7.5% or ± 0.75pF, whichever larger.								
		Class2	X7R X7S X7T		± 12.5 %									
Q (Class1)	<table border="1"> <thead> <tr> <th>Capacitance</th> <th>Q</th> </tr> </thead> <tbody> <tr> <td>30pF and over</td> <td>200 min.</td> </tr> <tr> <td>Under 30pF</td> <td>100+10/3×C min.</td> </tr> </tbody> </table> <p>C : Rated capacitance (pF)</p>		Capacitance	Q	30pF and over	200 min.	Under 30pF	100+10/3×C min.						
	Capacitance	Q												
30pF and over	200 min.													
Under 30pF	100+10/3×C min.													
D.F. (Class2)	Characteristics X7R/X7S/X7T : 200% of initial spec. max.													
Insulation Resistance	500MΩ or 25MΩ·μF min. (As for the capacitors of rated voltage 16V DC and item below, 500MΩ or 5MΩ·μF min.,) whichever smaller.													
21	Life	External appearance	No mechanical damage.	<p>Reflow solder the capacitors on a P.C.Board shown in Appendix 1a or Appendix 1b before testing.</p> <p>Test condition : maximum operating temperature ±2°C for 2,000 +48,0h</p> <p>As for applied voltage, please refer to “(4) Voltage condition in the life test” at page 2.</p> <p>Charge/discharge current shall not exceed 50mA.</p> <p>Leave the capacitors in ambient condition for 6 to 24h (Class1) or 24±2h (Class2) before measurement.</p> <p>Voltage conditioning Voltage treat the capacitors under testing temperature and voltage for 1 hour.</p> <p>Leave the capacitors in ambient condition for 24±2h before measurement.</p> <p>Use this measurement for initial value.</p>										
		Capacitance	<table border="1"> <thead> <tr> <th colspan="2">Characteristics</th> <th>Change from the value before test</th> </tr> </thead> <tbody> <tr> <td>Class1</td> <td>COG</td> <td>Capacitance drift within ± 3% or ± 0.3pF, whichever larger.</td> </tr> <tr> <td>Class2</td> <td>X7R X7S X7T</td> <td>± 15 %</td> </tr> </tbody> </table>		Characteristics		Change from the value before test	Class1	COG	Capacitance drift within ± 3% or ± 0.3pF, whichever larger.	Class2	X7R X7S X7T	± 15 %	
			Characteristics		Change from the value before test									
			Class1		COG	Capacitance drift within ± 3% or ± 0.3pF, whichever larger.								
		Class2	X7R X7S X7T		± 15 %									
Q (Class1)	<table border="1"> <thead> <tr> <th>Capacitance</th> <th>Q</th> </tr> </thead> <tbody> <tr> <td>30pF and over</td> <td>350 and over</td> </tr> <tr> <td>10pF and over to under 30pF</td> <td>275+5/2×C min.</td> </tr> <tr> <td>Under 10pF</td> <td>200+10×C min.</td> </tr> </tbody> </table> <p>C : Rated capacitance (pF)</p>		Capacitance	Q	30pF and over	350 and over	10pF and over to under 30pF	275+5/2×C min.	Under 10pF	200+10×C min.				
	Capacitance	Q												
30pF and over	350 and over													
10pF and over to under 30pF	275+5/2×C min.													
Under 10pF	200+10×C min.													
D.F. (Class2)	Characteristics X7R/X7S/X7T : 200% of initial spec. max.													
Insulation Resistance	1,000MΩ or 50MΩ·μF min. (As for the capacitors of rated voltage 16V DC and the item below, 1,000 MΩ or 10MΩ·μF min.,) whichever smaller.													

*As for the initial measurement of capacitors (Class2) on number 9, 13, 14, 15, 17, 18 and 19 leave capacitors at 150 –10,0°C for 1 hour and measure the value after leaving capacitors for 24±2h in ambient condition.

Appendix - 1a

P.C. Board for reliability test

Applied for CGJ2, CGJ3, CGJ4, CGJ5

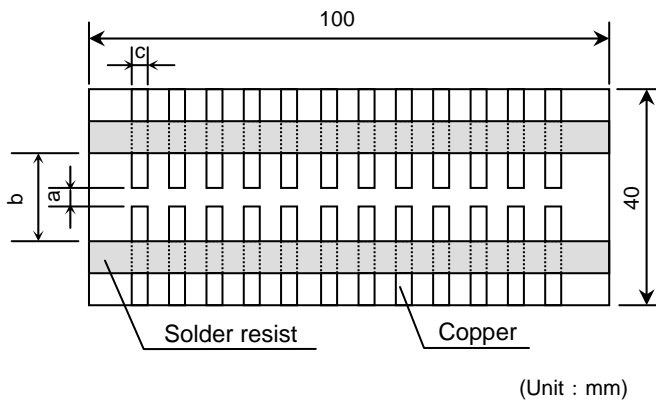

Appendix - 1b

P.C. Board for reliability test

Applied for CGJ6

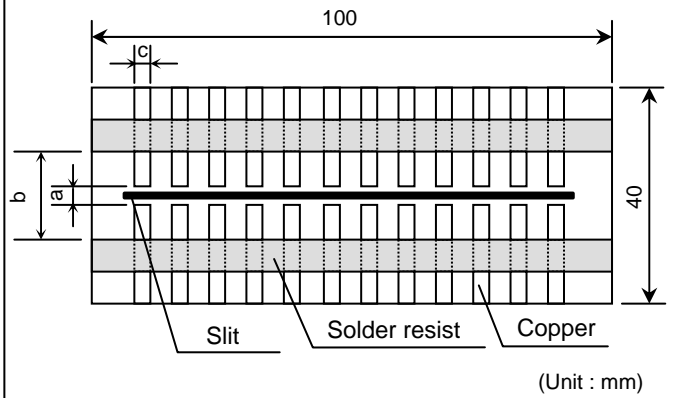

Appendix - 2a

P.C. Board for bending test

Applied for CGJ2

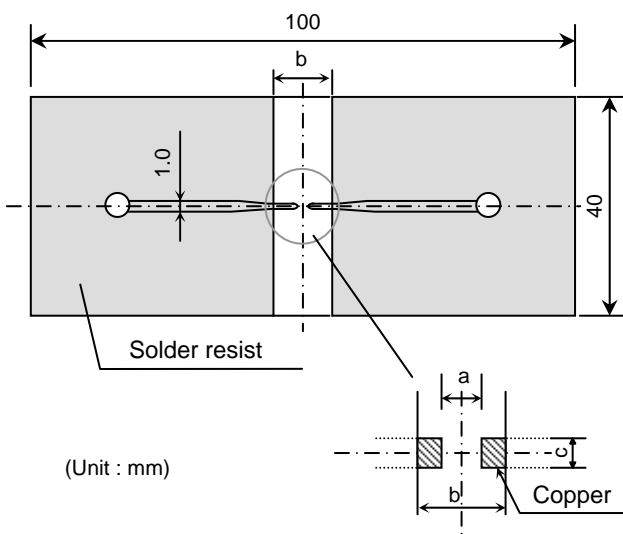

Appendix - 2b

P.C. Board for bending test

Applied for CGJ3, CGJ4, CGJ5, CGJ6

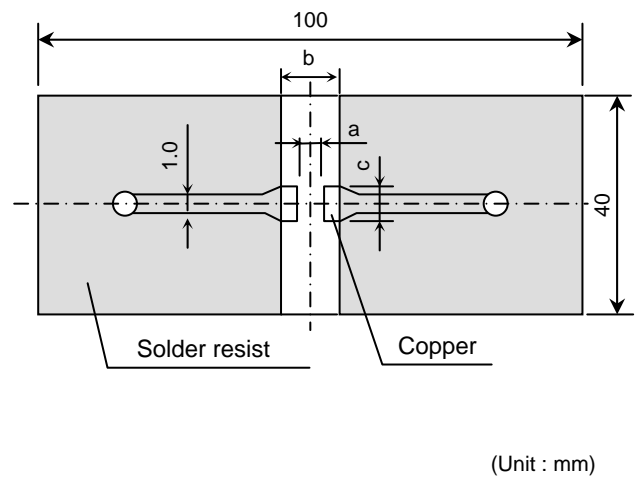

Material : Glass Epoxy (As per JIS C6484 GE4)

P.C. Board thickness : Appendix-2a 0.8mm

Appendix-1a, 1b, 2b 1.6mm

- Copper (thickness 0.035mm)
- Solder resist

TDK (EIA style)	Dimensions (mm)		
	a	b	c
CGJ2 (CC0402)	0.4	1.5	0.5
CGJ3 (CC0603)	1.0	3.0	1.2
CGJ4 (CC0805)	1.2	4.0	1.65
CGJ5 (CC1206)	2.2	5.0	2.0
CGJ6 (CC1210)	2.2	5.0	2.9

8. INSIDE STRUCTURE AND MATERIAL

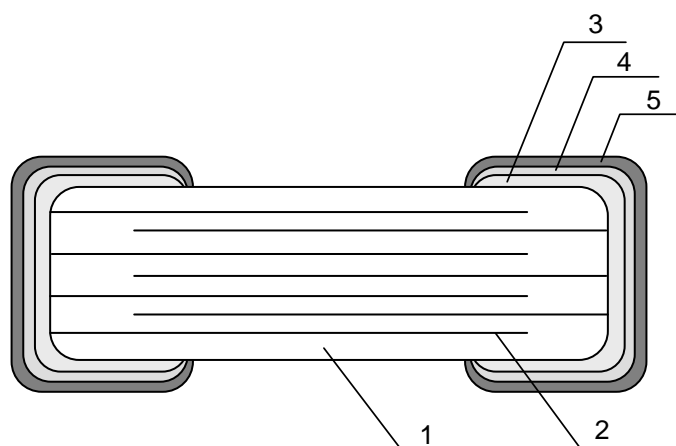



No.	NAME	MATERIAL	
		Class1	Class2
1	Dielectric	CaZrO ₃	BaTiO ₃
2	Electrode	Nickel (Ni)	
3	Termination	Copper (Cu)	
4		Nickel (Ni)	
5		Tin (Sn)	

9. SOLDERING CONDITION

As for CGJ2(CC0402) types, reflow soldering only.

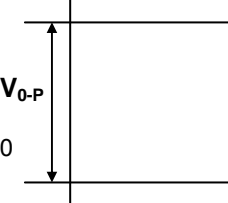
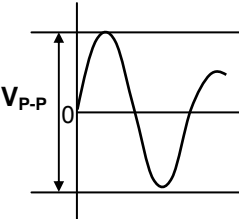
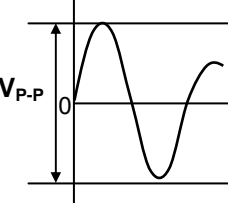
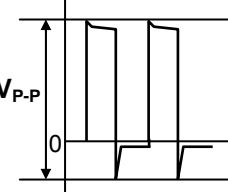
10. Caution

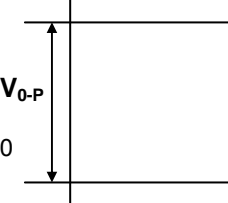
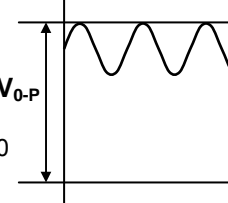
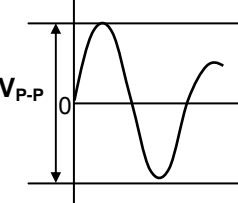
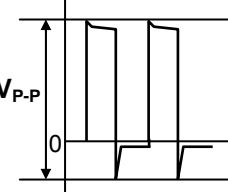
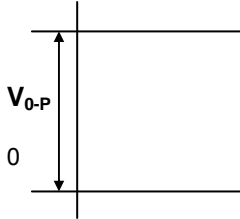
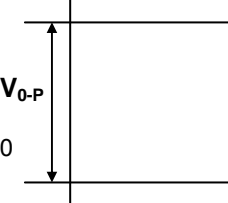
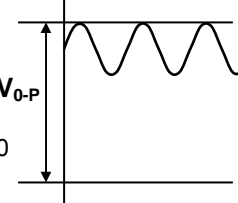
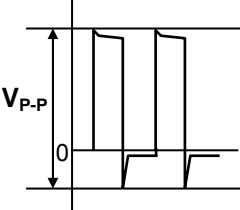
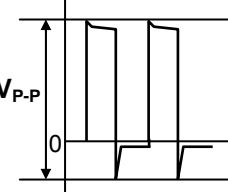
No.	Process	Condition														
1	Operating Condition (Storage, Transportation)	<p>1-1. Storage</p> <ol style="list-style-type: none"> 1) The capacitors must be stored in an ambient temperature of 5 to 40°C with a relative humidity of 20 to 70%RH. The products should be used within 6 months upon receipt. 2) The capacitors must be operated and stored in an environment free of dew condensation and these gases such as Hydrogen Sulphide, Hydrogen Sulphate, Chlorine, Ammonia and sulfur. 3) Avoid storing in sun light and falling of dew. 4) Do not use capacitors under high humidity and high and low atmospheric pressure which may affect capacitors reliability. 5) Capacitors should be tested for the solderability when they are stored for long time. <p>1-2. Handling in transportation</p> <p>In case of the transportation of the capacitors, the performance of the capacitors may be deteriorated depending on the transportation condition. (Refer to JEITA RCR-2335B 9.2 Handling in transportation)</p>														
2	Circuit design ⚠ Caution	<p>2-1. Operating temperature</p> <p>Operating temperature should be followed strictly within this specification, especially be careful with maximum temperature.</p> <ol style="list-style-type: none"> 1) Do not use capacitors above the maximum allowable operating temperature. 2) Surface temperature including self heating should be below maximum operating temperature. (Due to dielectric loss, capacitors will heat itself when AC is applied. Especially at high frequencies around its SRF, the heat might be so extreme that it may damage itself or the product mounted on. Please design the circuit so that the maximum temperature of the capacitors including the self heating to be below the maximum allowable operating temperature. Temperature rise at capacitor surface shall be below 20°C) 3) The electrical characteristics of the capacitors will vary depending on the temperature. The capacitors should be selected and designed in taking the temperature into consideration. <p>2-2. Operating voltage</p> <ol style="list-style-type: none"> 1) Operating voltage across the terminals should be below the rated voltage. When AC and DC are super imposed, V_{0-P} must be below the rated voltage. _____ (1) and (2) AC or pulse with overshooting, V_{P-P} must be below the rated voltage. _____ (3), (4) and (5) When the voltage is started to apply to the circuit or it is stopped applying, the irregular voltage may be generated for a transit period because of resonance or switching. Be sure to use the capacitors within rated voltage containing these Irregular voltage. <table border="1" data-bbox="472 1451 1445 1727"> <thead> <tr> <th data-bbox="472 1451 660 1496">Voltage</th> <th data-bbox="660 1451 922 1496">(1) DC voltage</th> <th data-bbox="922 1451 1184 1496">(2) DC+AC voltage</th> <th data-bbox="1184 1451 1445 1496">(3) AC voltage</th> </tr> </thead> <tbody> <tr> <td data-bbox="472 1496 660 1727">Positional Measurement (Rated voltage)</td> <td data-bbox="660 1496 922 1727">  </td> <td data-bbox="922 1496 1184 1727">  </td> <td data-bbox="1184 1496 1445 1727">  </td> </tr> </tbody> </table> <table border="1" data-bbox="472 1753 1184 2020"> <thead> <tr> <th data-bbox="472 1753 660 1798">Voltage</th> <th data-bbox="660 1753 922 1798">(4) Pulse voltage (A)</th> <th data-bbox="922 1753 1184 1798">(5) Pulse voltage (B)</th> </tr> </thead> <tbody> <tr> <td data-bbox="472 1798 660 2020">Positional Measurement (Rated voltage)</td> <td data-bbox="660 1798 922 2020">  </td> <td data-bbox="922 1798 1184 2020">  </td> </tr> </tbody> </table>	Voltage	(1) DC voltage	(2) DC+AC voltage	(3) AC voltage	Positional Measurement (Rated voltage)				Voltage	(4) Pulse voltage (A)	(5) Pulse voltage (B)	Positional Measurement (Rated voltage)		
Voltage	(1) DC voltage	(2) DC+AC voltage	(3) AC voltage													
Positional Measurement (Rated voltage)																
Voltage	(4) Pulse voltage (A)	(5) Pulse voltage (B)														
Positional Measurement (Rated voltage)																

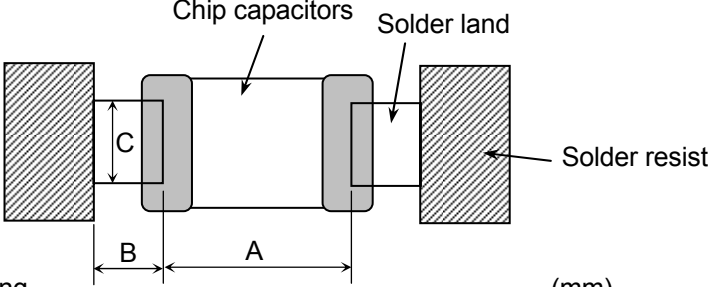
No.	Process	Condition																																												
2	Circuit design ⚠ Caution	<p>2) Even below the rated voltage, if repetitive high frequency AC or pulse is applied, the reliability of the capacitors may be reduced.</p> <p>3) The effective capacitance will vary depending on applied DC and AC voltages. The capacitors should be selected and designed in taking the voltages into consideration.</p> <p>2-3. Frequency When the capacitors (Class 2) are used in AC and/or pulse voltages, the capacitors may vibrate themselves and generate audible sound.</p>																																												
3	Designing P.C.board	<p>The amount of solder at the terminations has a direct effect on the reliability of the capacitors.</p> <p>1) The greater the amount of solder, the higher the stress on the chip capacitors, and the more likely that it will break. When designing a P.C.board, determine the shape and size of the solder lands to have proper amount of solder on the terminations.</p> <p>2) Avoid using common solder land for multiple terminations and provide individual solder land for each terminations.</p> <p>3) Size and recommended land dimensions.</p> <div style="text-align: center;">  <p>The diagram shows a top-down view of a chip capacitor mounted on a PCB. The capacitor is represented by two grey rectangular pads. The distance between the inner edges of these pads is labeled 'A'. The distance from the inner edge of the left pad to the edge of the solder resist is labeled 'B'. The height of the capacitor pads is labeled 'C'. Labels with arrows point to 'Chip capacitors', 'Solder land', and 'Solder resist'.</p> </div> <p style="text-align: center;">Flow soldering (mm)</p> <table border="1" style="width: 100%; border-collapse: collapse;"> <thead> <tr> <th style="text-align: center;">Type Symbol</th> <th style="text-align: center;">CGJ3 (CC0603)</th> <th style="text-align: center;">CGJ4 (CC0805)</th> <th style="text-align: center;">CGJ5 (CC1206)</th> </tr> </thead> <tbody> <tr> <td style="text-align: center;">A</td> <td style="text-align: center;">0.7 - 1.0</td> <td style="text-align: center;">1.0 - 1.3</td> <td style="text-align: center;">2.1 - 2.5</td> </tr> <tr> <td style="text-align: center;">B</td> <td style="text-align: center;">0.8 - 1.0</td> <td style="text-align: center;">1.0 - 1.2</td> <td style="text-align: center;">1.1 - 1.3</td> </tr> <tr> <td style="text-align: center;">C</td> <td style="text-align: center;">0.6 - 0.8</td> <td style="text-align: center;">0.8 - 1.1</td> <td style="text-align: center;">1.0 - 1.3</td> </tr> </tbody> </table> <p style="text-align: center;">Reflow soldering (mm)</p> <table border="1" style="width: 100%; border-collapse: collapse;"> <thead> <tr> <th style="text-align: center;">Type Symbol</th> <th style="text-align: center;">CGJ2 (CC0402)</th> <th style="text-align: center;">CGJ3 (CC0603)</th> <th style="text-align: center;">CGJ4 (CC0805)</th> <th style="text-align: center;">CGJ5 (CC1206)</th> </tr> </thead> <tbody> <tr> <td style="text-align: center;">A</td> <td style="text-align: center;">0.3 - 0.5</td> <td style="text-align: center;">0.6 - 0.8</td> <td style="text-align: center;">0.9 - 1.2</td> <td style="text-align: center;">2.0 - 2.4</td> </tr> <tr> <td style="text-align: center;">B</td> <td style="text-align: center;">0.35 - 0.45</td> <td style="text-align: center;">0.6 - 0.8</td> <td style="text-align: center;">0.7 - 0.9</td> <td style="text-align: center;">1.0 - 1.2</td> </tr> <tr> <td style="text-align: center;">C</td> <td style="text-align: center;">0.4 - 0.6</td> <td style="text-align: center;">0.6 - 0.8</td> <td style="text-align: center;">0.9 - 1.2</td> <td style="text-align: center;">1.1 - 1.6</td> </tr> </tbody> </table> <table border="1" style="width: 100%; border-collapse: collapse; margin-top: 10px;"> <thead> <tr> <th style="text-align: center;">Type Symbol</th> <th style="text-align: center;">CGJ6 (CC1210)</th> </tr> </thead> <tbody> <tr> <td style="text-align: center;">A</td> <td style="text-align: center;">2.0 - 2.4</td> </tr> <tr> <td style="text-align: center;">B</td> <td style="text-align: center;">1.0 - 1.2</td> </tr> <tr> <td style="text-align: center;">C</td> <td style="text-align: center;">1.9 - 2.5</td> </tr> </tbody> </table>	Type Symbol	CGJ3 (CC0603)	CGJ4 (CC0805)	CGJ5 (CC1206)	A	0.7 - 1.0	1.0 - 1.3	2.1 - 2.5	B	0.8 - 1.0	1.0 - 1.2	1.1 - 1.3	C	0.6 - 0.8	0.8 - 1.1	1.0 - 1.3	Type Symbol	CGJ2 (CC0402)	CGJ3 (CC0603)	CGJ4 (CC0805)	CGJ5 (CC1206)	A	0.3 - 0.5	0.6 - 0.8	0.9 - 1.2	2.0 - 2.4	B	0.35 - 0.45	0.6 - 0.8	0.7 - 0.9	1.0 - 1.2	C	0.4 - 0.6	0.6 - 0.8	0.9 - 1.2	1.1 - 1.6	Type Symbol	CGJ6 (CC1210)	A	2.0 - 2.4	B	1.0 - 1.2	C	1.9 - 2.5
Type Symbol	CGJ3 (CC0603)	CGJ4 (CC0805)	CGJ5 (CC1206)																																											
A	0.7 - 1.0	1.0 - 1.3	2.1 - 2.5																																											
B	0.8 - 1.0	1.0 - 1.2	1.1 - 1.3																																											
C	0.6 - 0.8	0.8 - 1.1	1.0 - 1.3																																											
Type Symbol	CGJ2 (CC0402)	CGJ3 (CC0603)	CGJ4 (CC0805)	CGJ5 (CC1206)																																										
A	0.3 - 0.5	0.6 - 0.8	0.9 - 1.2	2.0 - 2.4																																										
B	0.35 - 0.45	0.6 - 0.8	0.7 - 0.9	1.0 - 1.2																																										
C	0.4 - 0.6	0.6 - 0.8	0.9 - 1.2	1.1 - 1.6																																										
Type Symbol	CGJ6 (CC1210)																																													
A	2.0 - 2.4																																													
B	1.0 - 1.2																																													
C	1.9 - 2.5																																													

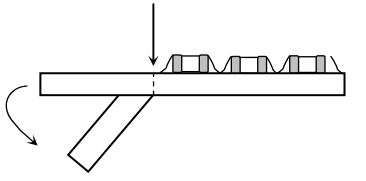
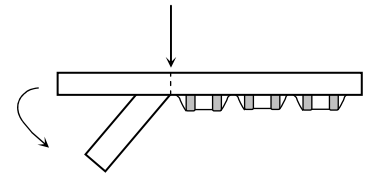
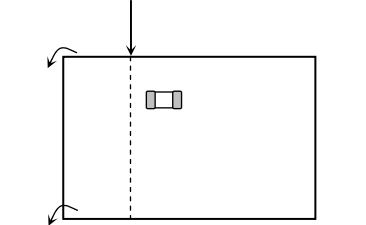
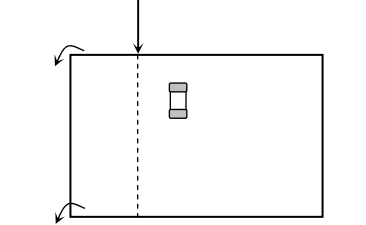
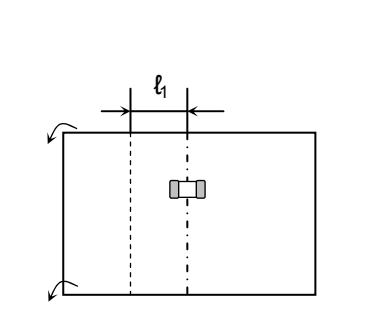
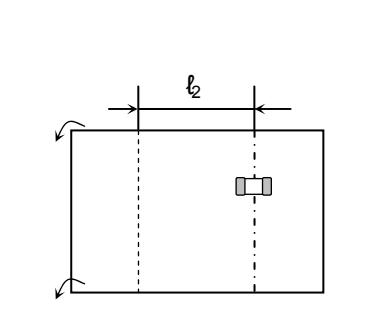
No.	Process	Condition	
3	Designing P.C.board	4) Recommended chip capacitors layout is as following. (CGJ2,CGJ3,CGJ4,CGJ5)	
		Disadvantage against bending stress	Advantage against bending stress
Mounting face	<p data-bbox="751 342 951 371">Perforation or slit</p>  <p data-bbox="699 607 948 674">Break P.C.board with mounted side up.</p>	<p data-bbox="1136 342 1335 371">Perforation or slit</p>  <p data-bbox="1091 607 1340 674">Break P.C.board with mounted side down.</p>	
Chip arrangement (Direction)	<p data-bbox="751 835 951 864">Perforation or slit</p> 	<p data-bbox="1136 835 1335 864">Perforation or slit</p> 	
Distance from slit	<p data-bbox="675 1171 1007 1200">Closer to slit is higher stress</p>  <p data-bbox="922 1541 1007 1570">$(l_1 < l_2)$</p>	<p data-bbox="1059 1171 1382 1200">Away from slit is less stress</p>  <p data-bbox="1315 1541 1399 1570">$(l_1 < l_2)$</p>	

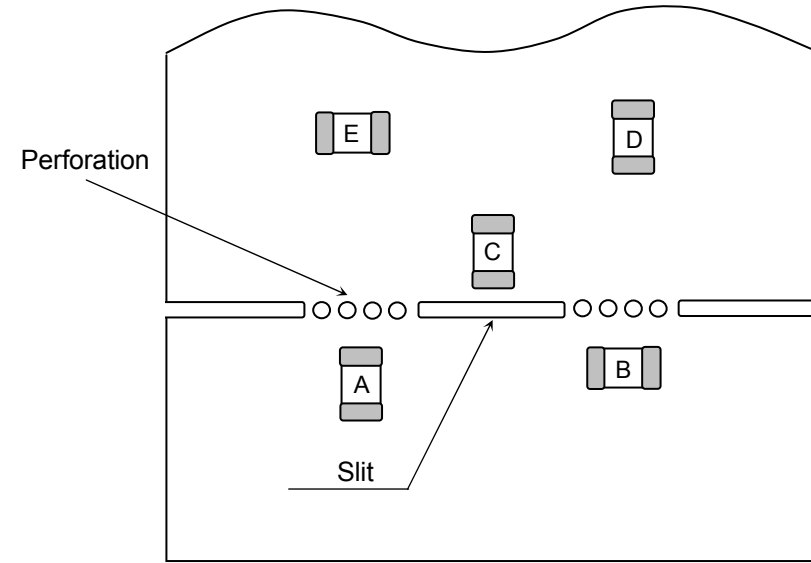
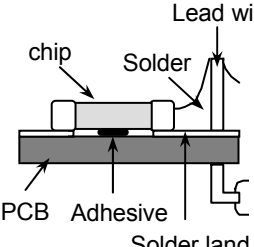
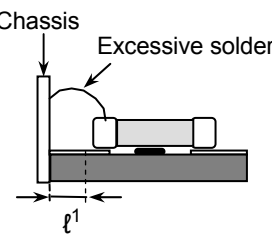
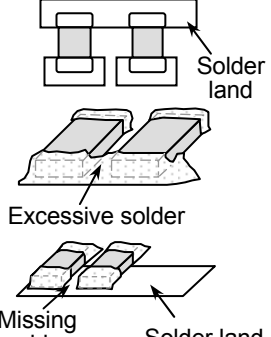
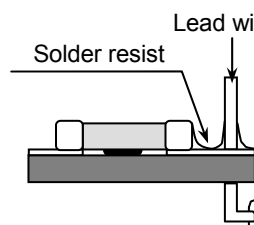
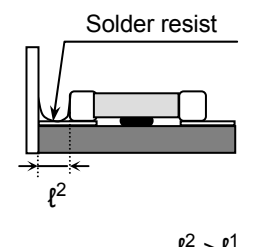
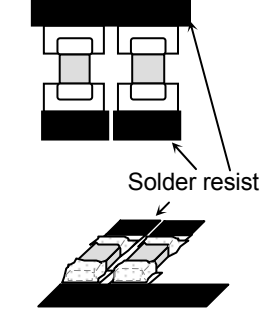
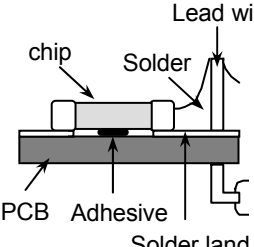
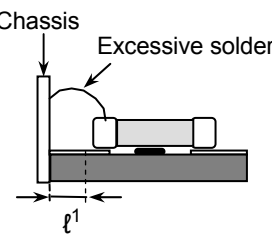
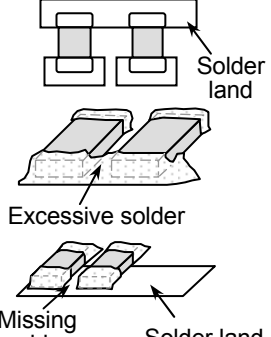
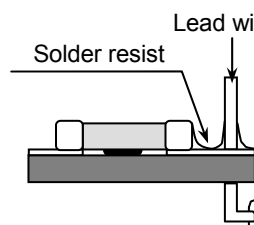
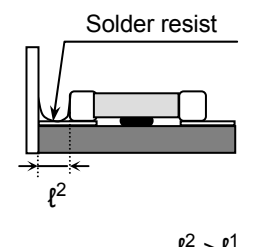
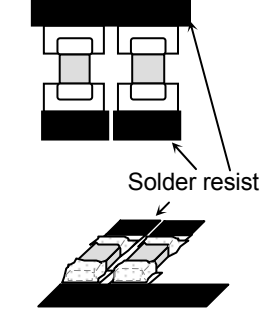
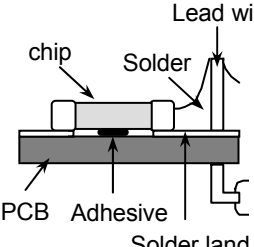
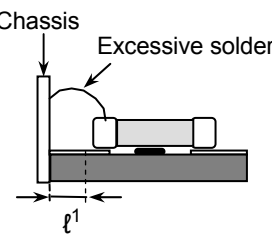
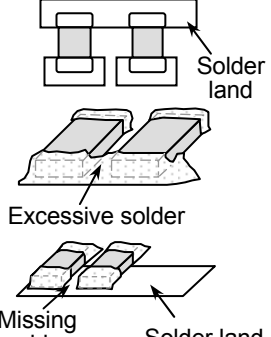
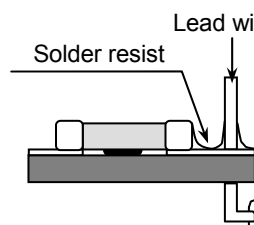
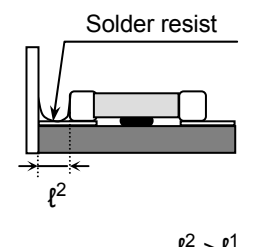
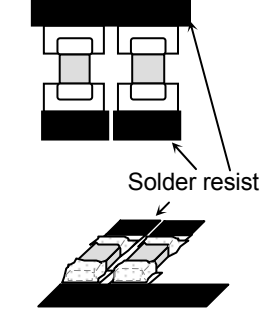
No.	Process	Condition												
3	Designing P.C.board	<p>5) Mechanical stress varies according to location of chip capacitors on the P.C.board.</p>  <p>The stress in capacitors is in the following order. $A > B = C > D > E$</p> <p>6) Layout recommendation</p> <table border="1"> <thead> <tr> <th data-bbox="379 1008 539 1120">Example</th> <th data-bbox="539 1008 842 1120">Use of common solder land</th> <th data-bbox="842 1008 1153 1120">Soldering with chassis</th> <th data-bbox="1153 1008 1481 1120">Use of common solder land with other SMD</th> </tr> </thead> <tbody> <tr> <td data-bbox="379 1120 539 1500">Need to avoid</td> <td data-bbox="539 1120 842 1500">  </td> <td data-bbox="842 1120 1153 1500">  </td> <td data-bbox="1153 1120 1481 1500">  </td> </tr> <tr> <td data-bbox="379 1500 539 1915">Recommendation</td> <td data-bbox="539 1500 842 1915">  </td> <td data-bbox="842 1500 1153 1915">  </td> <td data-bbox="1153 1500 1481 1915">  </td> </tr> </tbody> </table>	Example	Use of common solder land	Soldering with chassis	Use of common solder land with other SMD	Need to avoid				Recommendation			
Example	Use of common solder land	Soldering with chassis	Use of common solder land with other SMD											
Need to avoid														
Recommendation														

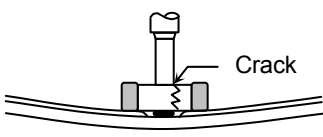
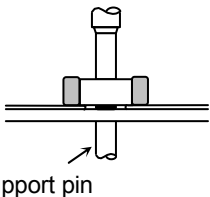
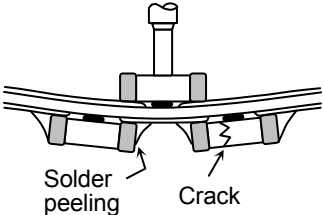
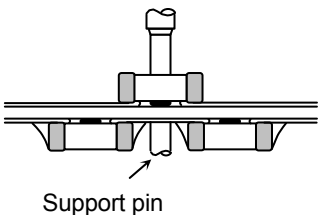
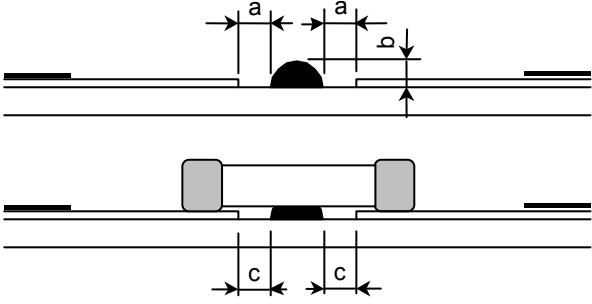
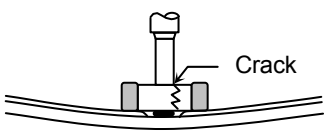
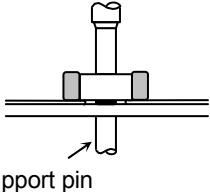
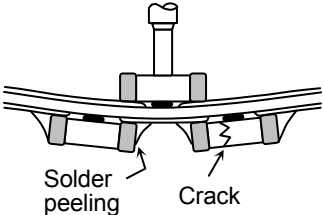
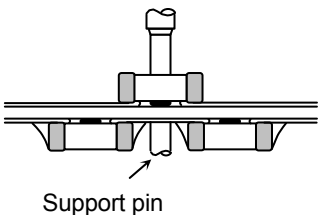
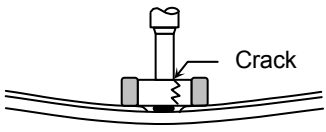
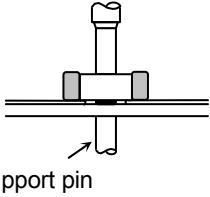
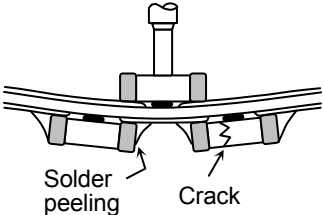
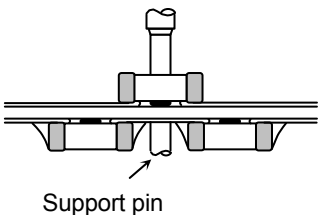
No.	Process	Condition															
4	Mounting	<p>4-1. Stress from mounting head If the mounting head is adjusted too low, it may induce excessive stress in the chip capacitors to result in cracking. Please take following precautions.</p> <ol style="list-style-type: none"> 1) Adjust the bottom dead center of the mounting head to reach on the P.C.board surface and not press it. 2) Adjust the mounting head pressure to be 1 to 3N of static weight. 3) To minimize the impact energy from mounting head, it is important to provide support from the bottom side of the P.C.board. See following examples. <table border="1" data-bbox="480 595 1433 1155"> <thead> <tr> <th></th> <th>Not recommended</th> <th>Recommended</th> </tr> </thead> <tbody> <tr> <td>Single sided mounting</td> <td></td> <td></td> </tr> <tr> <td>Double-sides mounting</td> <td></td> <td></td> </tr> </tbody> </table> <p>When the centering jaw is worn out, it may give mechanical impact on the capacitors to cause crack. Please control the close up dimension of the centering jaw and provide sufficient preventive maintenance and replacement of it.</p> <p>4-2. Amount of adhesive</p>  <p>Example : CGJ4 (CC0805), CGJ5 (CC1206)</p> <table border="1" data-bbox="663 1783 1214 1939"> <tbody> <tr> <td>a</td> <td>0.2mm min.</td> </tr> <tr> <td>b</td> <td>70 - 100μm</td> </tr> <tr> <td>c</td> <td>Do not touch the solder land</td> </tr> </tbody> </table>		Not recommended	Recommended	Single sided mounting			Double-sides mounting			a	0.2mm min.	b	70 - 100μm	c	Do not touch the solder land
	Not recommended	Recommended															
Single sided mounting																	
Double-sides mounting																	
a	0.2mm min.																
b	70 - 100μm																
c	Do not touch the solder land																

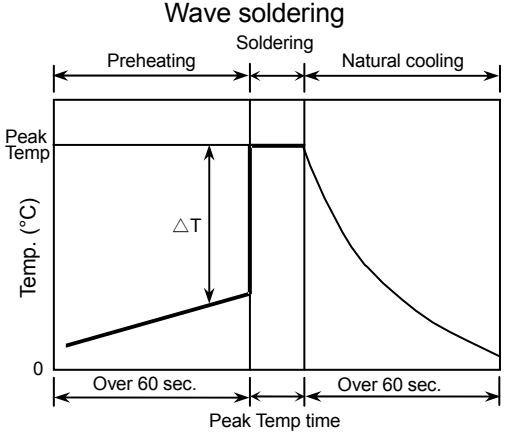
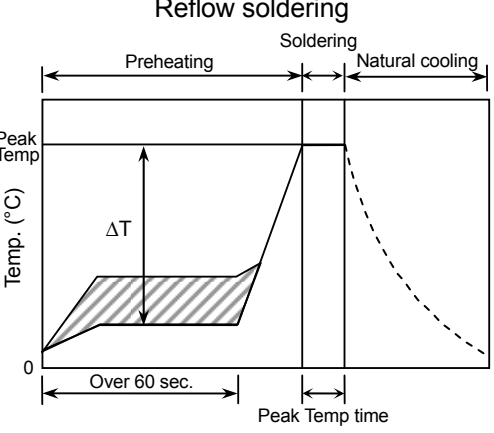
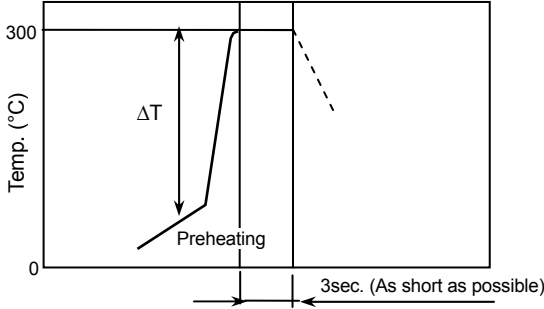
No.	Process	Condition																			
5	Soldering	<p>5-1. Flux selection</p> <p>Although highly-activated flux gives better solderability, substances which increase activity may also degrade the insulation of the chip capacitors. To avoid such degradation, it is recommended following.</p> <ol style="list-style-type: none"> 1) It is recommended to use a mildly activated rosin flux (less than 0.1wt% chlorine). Strong flux is not recommended. 2) Excessive flux must be avoided. Please provide proper amount of flux. 3) When water-soluble flux is used, enough washing is necessary. <p>5-2. Recommended soldering profile by various methods</p> <div style="display: flex; justify-content: space-around;"> <div style="text-align: center;"> <p>Wave soldering</p>  </div> <div style="text-align: center;"> <p>Reflow soldering</p>  </div> </div> <div style="text-align: center; margin-top: 20px;"> <p>Manual soldering (Solder iron)</p>  </div> <div style="margin-top: 20px;"> <p>APPLICATION</p> <p>As for CGJ3 (CC0603), CGJ4 (CC0805) and CGJ5 (CC1206), applied to wave soldering and reflow soldering.</p> <p>As for CGJ2 (CC0402) and CGJ6 (CC1210), applied only to reflow soldering.</p> </div> <p>5-3. Recommended soldering peak temp and peak temp duration</p> <table border="1" style="width: 100%; border-collapse: collapse;"> <thead> <tr> <th rowspan="2" style="text-align: center;">Temp./Duration</th> <th colspan="2" style="text-align: center;">Wave soldering</th> <th colspan="2" style="text-align: center;">Reflow soldering</th> </tr> <tr> <th style="text-align: center;">Peak temp(°C)</th> <th style="text-align: center;">Duration(sec.)</th> <th style="text-align: center;">Peak temp(°C)</th> <th style="text-align: center;">Duration(sec.)</th> </tr> </thead> <tbody> <tr> <td style="text-align: center;">Pb-Sn Solder</td> <td style="text-align: center;">250 max.</td> <td style="text-align: center;">3 max.</td> <td style="text-align: center;">230 max.</td> <td style="text-align: center;">20 max.</td> </tr> <tr> <td style="text-align: center;">Lead Free Solder</td> <td style="text-align: center;">260 max.</td> <td style="text-align: center;">5 max.</td> <td style="text-align: center;">260 max.</td> <td style="text-align: center;">10 max.</td> </tr> </tbody> </table> <p>Recommended solder compositions</p> <p>Sn-37Pb (Pb-Sn solder)</p> <p>Sn-3.0Ag-0.5Cu (Lead Free Solder)</p>	Temp./Duration	Wave soldering		Reflow soldering		Peak temp(°C)	Duration(sec.)	Peak temp(°C)	Duration(sec.)	Pb-Sn Solder	250 max.	3 max.	230 max.	20 max.	Lead Free Solder	260 max.	5 max.	260 max.	10 max.
Temp./Duration	Wave soldering			Reflow soldering																	
	Peak temp(°C)	Duration(sec.)	Peak temp(°C)	Duration(sec.)																	
Pb-Sn Solder	250 max.	3 max.	230 max.	20 max.																	
Lead Free Solder	260 max.	5 max.	260 max.	10 max.																	

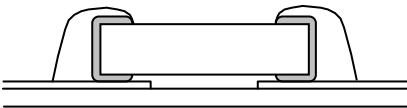
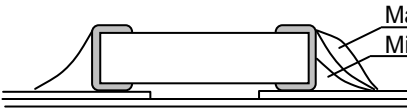
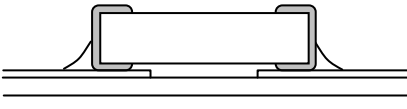
No.	Process	Condition																
5	Soldering	<p>5-4. Avoiding thermal shock</p> <p>1) Preheating condition</p> <table border="1" data-bbox="552 315 1426 667"> <thead> <tr> <th>Soldering</th> <th>Type</th> <th>Temp. (°C)</th> </tr> </thead> <tbody> <tr> <td>Wave soldering</td> <td>CGJ3(CC0603), CGJ4(CC0805)</td> <td>$\Delta T \leq 150$</td> </tr> <tr> <td rowspan="2">Reflow soldering</td> <td>CGJ2(CC0402), CGJ3(CC0603), CGJ4(CC0805), CGJ5(CC1206)</td> <td>$\Delta T \leq 150$</td> </tr> <tr> <td>CGJ6(CC1210)</td> <td>$\Delta T \leq 130$</td> </tr> <tr> <td rowspan="2">Manual soldering</td> <td>CGJ2(CC0402), CGJ3(CC0603), CGJ4(CC0805), CGJ5(CC1206)</td> <td>$\Delta T \leq 150$</td> </tr> <tr> <td>CGJ6(CC1210)</td> <td>$\Delta T \leq 130$</td> </tr> </tbody> </table> <p>2) Cooling condition Natural cooling using air is recommended. If the chips are dipped into a solvent for cleaning, the temperature difference (ΔT) must be less than 100°C.</p> <p>5-5. Amount of solder Excessive solder will induce higher tensile force in chip capacitors when temperature changes and it may result in chip cracking. In sufficient solder may detach the capacitors from the P.C.board.</p> <div style="display: flex; justify-content: space-between; align-items: flex-start;"> <div style="width: 30%;"> <p>Excessive solder</p> </div> <div style="width: 30%; text-align: center;">  </div> <div style="width: 30%;"> <p>Higher tensile force in chip capacitors to cause crack</p> </div> </div> <hr/> <div style="display: flex; justify-content: space-between; align-items: flex-start;"> <div style="width: 30%;"> <p>Adequate</p> </div> <div style="width: 30%; text-align: center;">  </div> <div style="width: 30%;"></div> </div> <hr/> <div style="display: flex; justify-content: space-between; align-items: flex-start;"> <div style="width: 30%;"> <p>Insufficient solder</p> </div> <div style="width: 30%; text-align: center;">  </div> <div style="width: 30%;"> <p>Low robustness may cause contact failure or chip capacitors come off the P.C.board.</p> </div> </div> <hr/> <p>5-6. Solder repair by solder iron</p> <p>1) Selection of the soldering iron tip Tip temperature of solder iron varies by its type, P.C.board material and solder land size. The higher the tip temperature, the quicker the operation. However, heat shock may cause a crack in the chip capacitors. Please make sure the tip temp. before soldering and keep the peak temp and time in accordance with following recommended condition. (Please preheat the chip capacitors with the condition in 5-4 to avoid the thermal shock.)</p>	Soldering	Type	Temp. (°C)	Wave soldering	CGJ3(CC0603), CGJ4(CC0805)	$\Delta T \leq 150$	Reflow soldering	CGJ2(CC0402), CGJ3(CC0603), CGJ4(CC0805), CGJ5(CC1206)	$\Delta T \leq 150$	CGJ6(CC1210)	$\Delta T \leq 130$	Manual soldering	CGJ2(CC0402), CGJ3(CC0603), CGJ4(CC0805), CGJ5(CC1206)	$\Delta T \leq 150$	CGJ6(CC1210)	$\Delta T \leq 130$
Soldering	Type	Temp. (°C)																
Wave soldering	CGJ3(CC0603), CGJ4(CC0805)	$\Delta T \leq 150$																
Reflow soldering	CGJ2(CC0402), CGJ3(CC0603), CGJ4(CC0805), CGJ5(CC1206)	$\Delta T \leq 150$																
	CGJ6(CC1210)	$\Delta T \leq 130$																
Manual soldering	CGJ2(CC0402), CGJ3(CC0603), CGJ4(CC0805), CGJ5(CC1206)	$\Delta T \leq 150$																
	CGJ6(CC1210)	$\Delta T \leq 130$																

No.	Process	Condition								
5	Soldering	<p style="text-align: center;">Recommended solder iron condition (Pb-Sn Solder and Lead Free Solder)</p> <table border="1" style="margin-left: auto; margin-right: auto;"> <thead> <tr> <th data-bbox="552 241 762 293">Temp. (°C)</th> <th data-bbox="762 241 970 293">Duration (sec.)</th> <th data-bbox="970 241 1177 293">Wattage (W)</th> <th data-bbox="1177 241 1385 293">Shape (mm)</th> </tr> </thead> <tbody> <tr> <td data-bbox="552 293 762 360">300 max.</td> <td data-bbox="762 293 970 360">3 max.</td> <td data-bbox="970 293 1177 360">20 max.</td> <td data-bbox="1177 293 1385 360">Ø 3.0 max.</td> </tr> </tbody> </table> <p>2) Direct contact of the soldering iron with ceramic dielectric of chip capacitors may cause crack. Do not touch the ceramic dielectric and the terminations by solder iron.</p> <p>5-7. Sn-Zn solder Sn-Zn solder affects product reliability. Please contact TDK in advance when utilize Sn-Zn solder.</p> <p>5-8. Countermeasure for tombstone The misalignment between the mounted positions of the capacitors and the land patterns should be minimized. The tombstone phenomenon may occur especially the capacitors are mounted (in longitudinal direction) in the same direction of the reflow soldering. (Refer to JEITA RCR-2335B Annex A (Informative) Recommendations to prevent the tombstone phenomenon)</p>	Temp. (°C)	Duration (sec.)	Wattage (W)	Shape (mm)	300 max.	3 max.	20 max.	Ø 3.0 max.
Temp. (°C)	Duration (sec.)	Wattage (W)	Shape (mm)							
300 max.	3 max.	20 max.	Ø 3.0 max.							
6	Cleaning	<p>1) If an unsuitable cleaning fluid is used, flux residue or some foreign articles may stick to chip capacitors surface to deteriorate especially the insulation resistance.</p> <p>2) If cleaning condition is not suitable, it may damage the chip capacitors.</p> <p>2)-1. Insufficient washing</p> <p>(1) Terminal electrodes may corrode by Halogen in the flux.</p> <p>(2) Halogen in the flux may adhere on the surface of capacitors, and lower the insulation resistance.</p> <p>(3) Water soluble flux has higher tendency to have above mentioned problems (1) and (2).</p> <p>2)-2. Excessive washing</p> <p>When ultrasonic cleaning is used, excessively high ultrasonic energy output can affect the connection between the ceramic chip capacitor's body and the terminal electrode. To avoid this, following is the recommended condition.</p> <p style="text-align: center;">Power : 20 W/l max. Frequency : 40 kHz max. Washing time : 5 minutes max.</p> <p>2)-3. If the cleaning fluid is contaminated, density of Halogen increases, and it may bring the same result as insufficient cleaning.</p>								

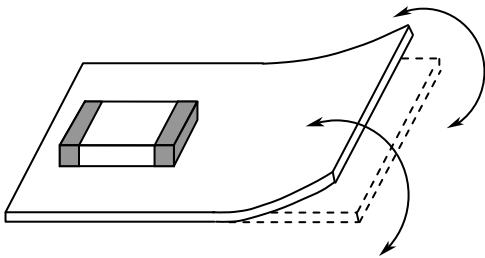
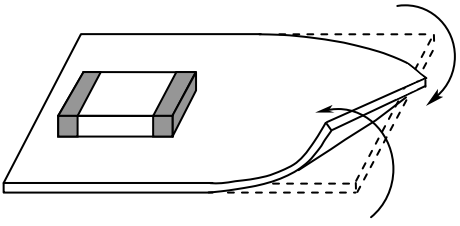
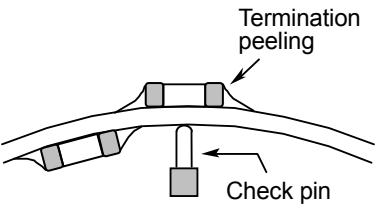
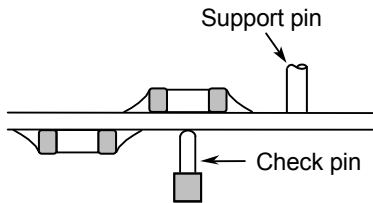
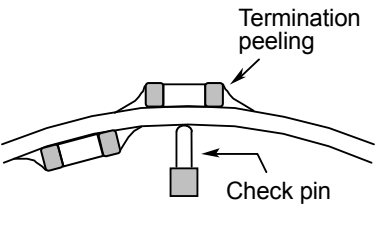
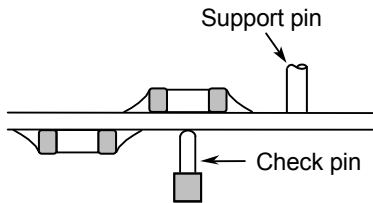
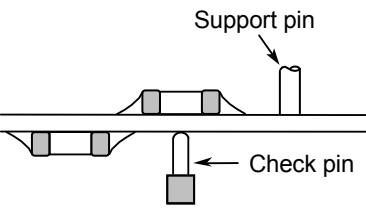
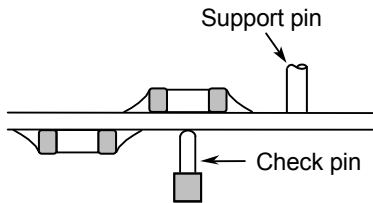
No.	Process	Condition						
7	Coating and molding of the P.C.board	<p>1) When the P.C.board is coated, please verify the quality influence on the product.</p> <p>2) Please verify carefully that there is no harmful decomposing or reaction gas emission during curing which may damage the chip capacitors.</p> <p>3) Please verify the curing temperature.</p>						
8	Handling after chip mounted  Caution	<p>1) Please pay attention not to bend or distort the P.C.board after soldering in handling otherwise the chip capacitors may crack.</p> <div style="display: flex; justify-content: space-around; align-items: center;"> <div style="text-align: center;"> <p>Bend</p>  </div> <div style="text-align: center;"> <p>Twist</p>  </div> </div> <p>2) When functional check of the P.C.board is performed, check pin pressure tends to be adjusted higher for fear of loose contact. But if the pressure is excessive and bend the P.C.board, it may crack the chip capacitors or peel the terminations off. Please adjust the check pins not to bend the P.C.board.</p> <table border="1" style="width: 100%; border-collapse: collapse;"> <thead> <tr> <th data-bbox="491 1189 630 1249">Item</th> <th data-bbox="630 1189 1050 1249">Not recommended</th> <th data-bbox="1050 1189 1449 1249">Recommended</th> </tr> </thead> <tbody> <tr> <td data-bbox="491 1249 630 1547" style="text-align: center; vertical-align: middle;">Board bending</td> <td data-bbox="630 1249 1050 1547" style="text-align: center;">  <p>Termination peeling</p> <p>Check pin</p> </td> <td data-bbox="1050 1249 1449 1547" style="text-align: center;">  <p>Support pin</p> <p>Check pin</p> </td> </tr> </tbody> </table>	Item	Not recommended	Recommended	Board bending	 <p>Termination peeling</p> <p>Check pin</p>	 <p>Support pin</p> <p>Check pin</p>
Item	Not recommended	Recommended						
Board bending	 <p>Termination peeling</p> <p>Check pin</p>	 <p>Support pin</p> <p>Check pin</p>						

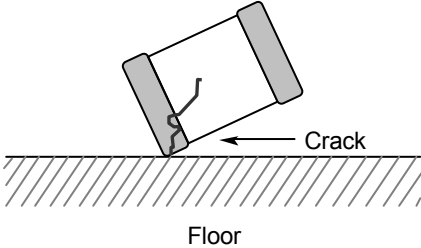
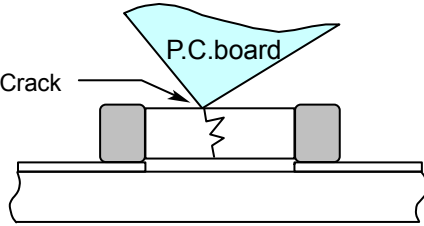
No.	Process	Condition
9	Handling of loose chip capacitors	<p>1) If dropped the chip capacitors may crack. Once dropped do not use it. Especially, the large case sized chip capacitors are tendency to have cracks easily, so please handle with care.</p>  <p>2) Piling the P.C.board after mounting for storage or handling, the corner of the P.C. board may hit the chip capacitors of another board to cause crack.</p> 
10	Capacitance aging	The capacitors (Class 2) have aging in the capacitance. They may not be used in precision time constant circuit. In case of the time constant circuit, the evaluation should be done well.
11	Estimated life and estimated failure rate of capacitors	<p>The estimated life and failure rate depend on the applied temperature and the voltage. This can be calculated by the equation described in JEITA RCR-2335B Annex 6(Informative) "Calculation of the estimated life time and the estimated failure rate."</p> <p>(Voltage acceleration coefficient : 3 multiplication rule, Temperature acceleration coefficient : 10°C rule)</p> <p>The failure rate can be decreased by reducing the temperature and the voltage but they will not be guaranteed.</p>

11. PACKAGING LABEL

11.1 Packaging shall be done to protect the components from the damage during transportation and storing, and a label which has the following information shall be attached.

(See Figure. 11.1)

- 1) Inspection No.
- 2) TDK P/N
- 3) Customer's P/N
- 4) Quantity

*Composition of Inspection No.

Example F 2 A - 00 - 000
 (a) (b) (c) (d) (e)

- a) Line code
- b) Last digit of the year
- c) Month and A for January and B for February and so on. (Skip I)
- d) Inspection Date of the month.
- e) Serial No. of the day

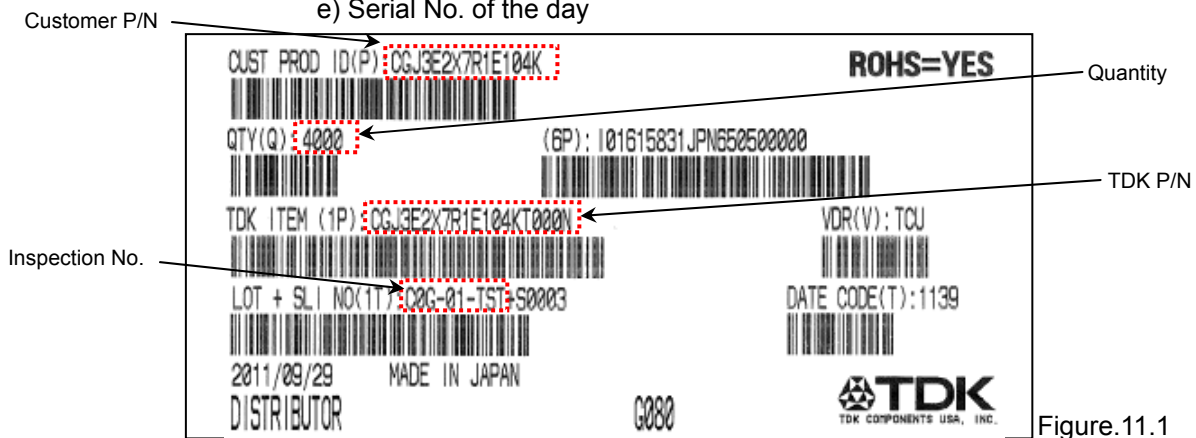

Figure.11.1

11.2 Anti-counterfeit Label

The anti-counterfeit label with a unique identification code is placed over the reel flanges to ensure material authenticity.

Product authentication can be confirmed by visiting TDK.com and entering the requested information. The secure on-line system will provide an immediate response to the authenticity of the TDK product from the information provided.



Figure.11.2

DO NOT USE if: the seal is broken or evidence of tampering is present.

Contact your local TDK representative for further instructions.

11.3 Radio Frequency Identification (RFID) label.

TDK's optional RFID reel tags are commissioned with lot specific information such as: lot number, customer part number, and quantity. RFID reel tag data can be customized to meet individual customer RFID requirements, as up to 64 bits of data can be stored on the RFID tag. Please contact your TDK sales representative for more information regarding customized information for RFID reel tags.

Below is an example of TDK standard RFID reel tag data (red font indicates data identifiers).

PCGJ2B1C104K, 1PCGJ2B2X7R1C104KT000N, Q10000
 (customer part no.) (TDK item description) (reel quantity)

TDK's RFID tag is compliant to ISO/IEC 18000-6 :2010 requirements and can be read within the standard operating frequency range for the United States (902-928Mhz) and international regulated frequencies within the Ultra High Frequency (UHF) bandwidth for Europe (865-868Mhz) and Japan (952-957Mhz).

12. TAPE PACKAGING SPECIFICATION

1. CONSTRUCTION AND DIMENSION OF TAPING

1-1. Dimensions of carrier tape

Dimensions of paper tape shall be according to Appendix 3, 4.

Dimensions of plastic tape shall be according to Appendix 5.

1-2. Bulk part and leader of taping

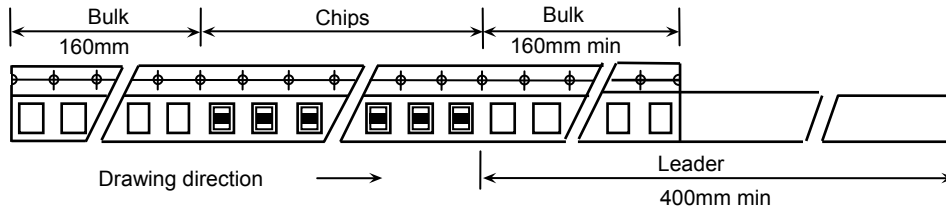

1-3. Dimensions of reel

Dimensions of Ø178 reel shall be according to Appendix 6, 7.

Dimensions of Ø330 reel shall be according to Appendix 8, 9.

1-4. Structure of taping

Type 1

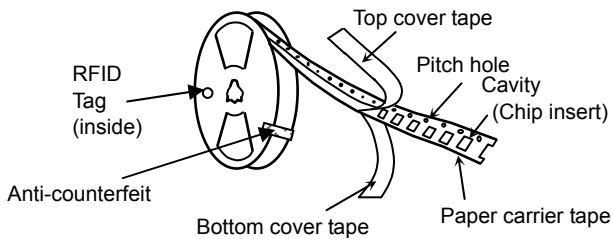

Type 2

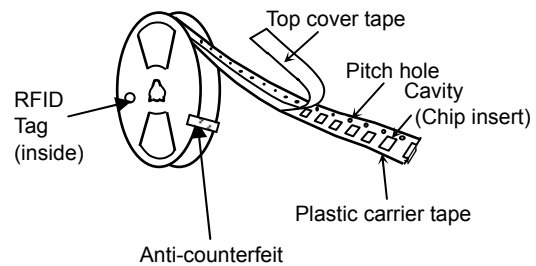

2. CHIP QUANTITY

Type	Thickness of chip	Taping Material	Chip quantity(pcs.)	
			Ø 178mm reel	Ø 330mm reel
CGJ2	0.50 mm	Paper	10,000	50,000
CGJ3	0.80 mm	Paper	4,000	10,000
CGJ4	0.60mm	Paper	4,000	10,000
	0.85 mm	Paper		
	1.25 mm	Plastic	2,000	
CGJ5	0.60 mm	Paper	4,000	10,000
	0.85 mm			
	1.15 mm	Plastic	2,000	
	1.30 mm			
1.60 mm		8,000		
CGJ6	1.60 mm	Plastic	2,000	8,000
	2.00 mm		1,000	5,000

3. PERFORMANCE SPECIFICATIONS

3-1. Fixing peeling strength (top tape)

0.05-0.7N. (See the following figure.)

TYPE 1 (Paper)

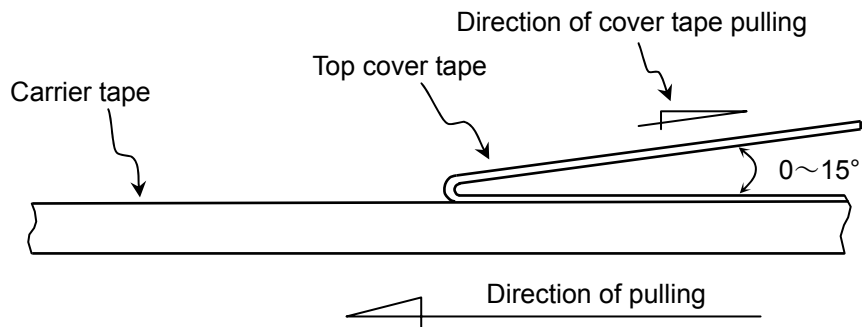

TYPE 2 (Plastic)

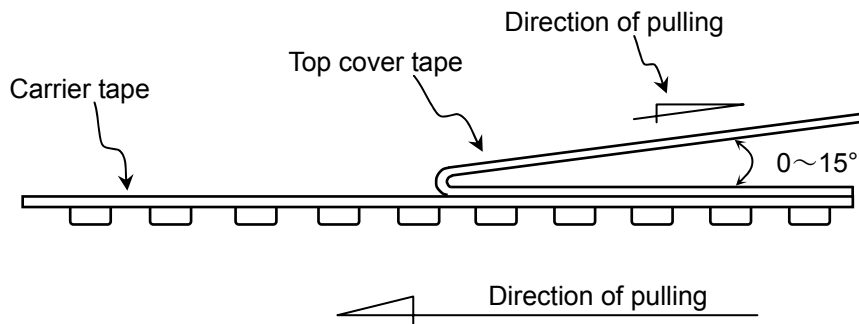

3-2. Carrier tape shall be flexible enough to be wound around a minimum radius of 30mm with components in tape.

3-3. The missing of components shall be less than 0.1%

3-4. Components shall not stick to fixing tape.

3-5. The fixing tapes shall not protrude beyond the edges of the carrier tape not shall cover the sprocket holes.

13. Sigma Report

Sigma Report will be performed for each lot. The results will be available on-line by visiting TDK.com and entering the requested information.

The Sigma Report will include performance (electrical and mechanical) and reliability metrics (FIT and MTTF).

A list of test completed is provided below.

Ref.	Test
1	Appearance
2	Destructive Physical Analysis
3	Insulation Resistance
4	Voltage Proof
5	Capacitance
6/7	Q/DF
8/9	Tem. Characteristics
11	Bending
12	Solderability
21	Life
	HALT
	Physical Dimensions

14. Warranty

TDK's CGJ Series MLCCs are designed and warranted to meet the performance standards shown in Table 1 of Section 7 (Performance Table) of this specification using the test and inspection methods specified herein.

While TDK's CGJ Series MLCCs are intended for high reliability applications within the range of conditions set forth in this specification, TDK is not aware of all applications in which these parts may be used, or the requirements of your particular application.

This series is not designed or warranted to meet any specifications of any intermediate or end user different from or in addition to those contained in this specification, nor are they intended or warranted for use in the applications excluded below.

Excluded Applications:

- Aerospace/aviation equipment (where the application is related to flight);
- FDA Class III medical equipment (and including any in-the-body medical application or any other medical application where the TDK part could possibly endanger human life or health);
- Nuclear energy-related equipment; and/or
- Military equipment (where designed to (i) destructive or explosive functionality including ammunition, firearms, warheads, mines and/or bombs, or (ii) discharging, emitting or blast-off functionality including artillery or missiles, or (iii) military aircraft or spacecraft).

Additionally, if you intend to use TDK's CGJ Series MLCCs in any of the applications listed below ("Specialized Applications"), you should carefully review the requirements of the particular application as against this specification so as to ensure the suitability of these parts for that application. TDK cannot ensure the suitability of these parts for the Specialized Applications below.

Specialized Applications:

- FDA Class I & II medical equipment (with the sale of parts for FDA Class II applications subject to prior TDK consultation).
- Transportation equipment (electric trains, ships, etc.)
[other than automotive applications];
- Transportation control equipment;
- Power-generation control equipment;
- Seabed equipment;
- Public information processing equipment;
- Electric heating apparatus and/or burning equipment;
- Disaster/crime prevention equipment; and/or
- Safety equipment.

TDK MAKES NO OTHER WARRANTIES, EXPRESS OR IMPLIED, INCLUDING THE WARRANTIES OF MERCHANTABILITY AND/OR FITNESS FOR A PARTICULAR PURPOSE.
IN NO EVENT SHALL TDK BE RESPONSIBLE FOR ANY DAMAGE OR LIABILITY CAUSED BY USE OF THESE PARTS
IN ANY OF THE EXCLUDED APPLICATIONS LISTED ABOVE OR FOR ANY OTHER USE EXCEEDING THE RANGE OR CONDITIONS SET FORTH IN THIS SPECIFICATION.

Please note that when designing your product, device, or equipment—even for general purpose applications - you should secure a protection circuit/device or provide backup circuits in your product, device, or equipment.

Appendix 3

Paper Tape

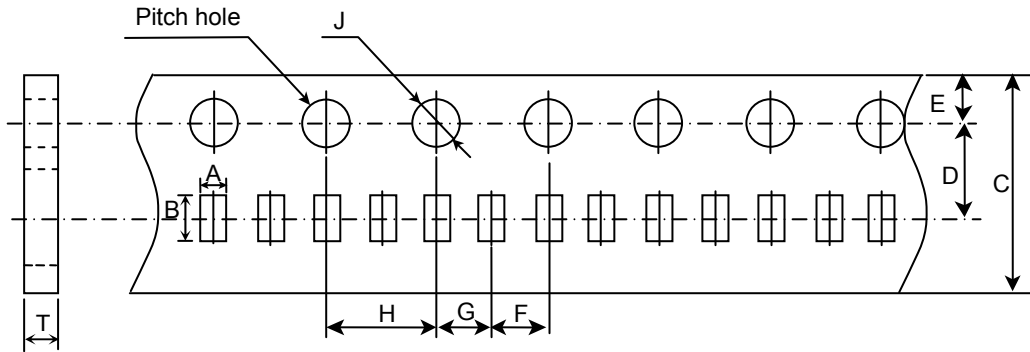

(Unit : mm)

Symbol	A	B	C	D	E	F
Type						
CGJ2 (CC0402)	(0.65)	(1.15)	8.00 ± 0.30	3.50 ± 0.05	1.75 ± 0.10	2.00 ± 0.05

Symbol	G	H	J	T
Type				
CGJ2 (CC0402)	2.00 ± 0.05	4.00 ± 0.10	$\varnothing 1.5 \begin{smallmatrix} +0.10 \\ 0 \end{smallmatrix}$	0.60 ± 0.15

* The values in the parentheses () are for reference

Appendix 4

Paper Tape

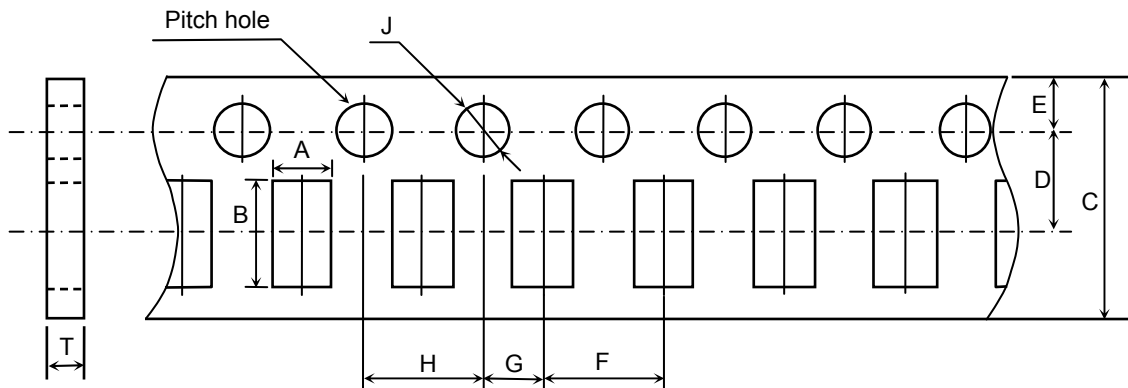

(Unit : mm)

Symbol	A	B	C	D	E	F
Type						
CGJ3 (CC0603)	(1.10)	(1.90)	8.00 ± 0.30	3.50 ± 0.05	1.75 ± 0.10	4.00 ± 0.10
CGJ4 (CC0805)	(1.50)	(2.30)				
CGJ5 (CC1206)	(1.90)	(3.50)				

Symbol	G	H	J	T
Type				
CGJ3 (CC0603)	2.00 ± 0.05	4.00 ± 0.10	$\varnothing 1.5 \begin{smallmatrix} +0.10 \\ 0 \end{smallmatrix}$	1.20 max.
CGJ4 (CC0805)				
CGJ5 (CC1206)				

* The values in the parentheses () are for reference.

Appendix 5

Plastic Tape

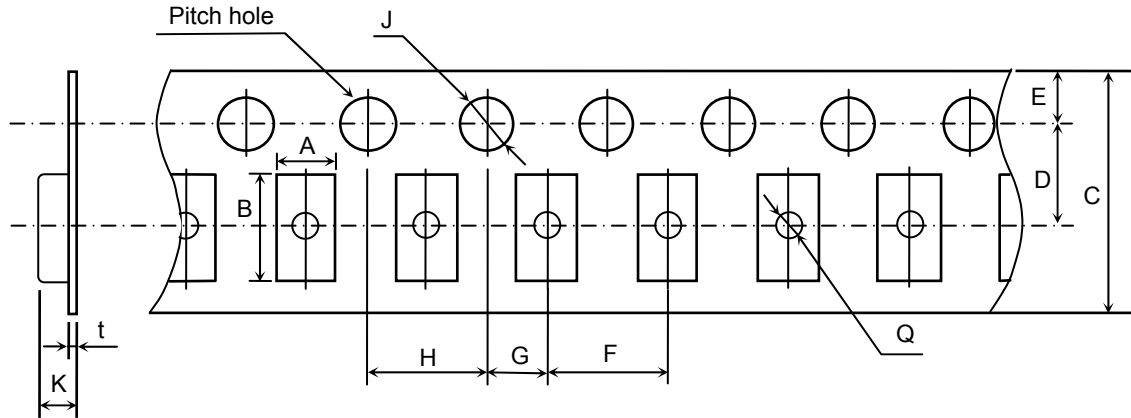

(Unit : mm)

Symbol Type	A	B	C	D	E	F
CGJ4 (CC0805)	(1.50)	(2.30)	8.00 ± 0.30 [12.0 ± 0.30]	3.50 ± 0.05 [5.50 ± 0.05]	1.75 ± 0.10	4.00 ± 0.10
CGJ5 (CC1206)	(1.90)	(3.50)				
CGJ6 (CC1210)	(2.90)	(3.60)				
Symbol Type	G	H	J	K	t	Q
CGJ4 (CC0805)	2.00 ± 0.05	4.00 ± 0.10	∅ 1.5 ^{+0.10} ₀	2.50 max.	0.30 max.	∅ 0.50 min.
CGJ5 (CC1206)				3.20 max.	0.60 max.	
CGJ6 (CC1210)						

* The values in the parentheses () are for reference.

* As for 2.5mm thickness products, apply values in the brackets [].

Appendix 7

CGJ2, CGJ3, CGJ4, CGJ5, CGJ6 (As for CGJ6 type, any thickness of the item except 2.5mm)

(Material : Polystyrene)

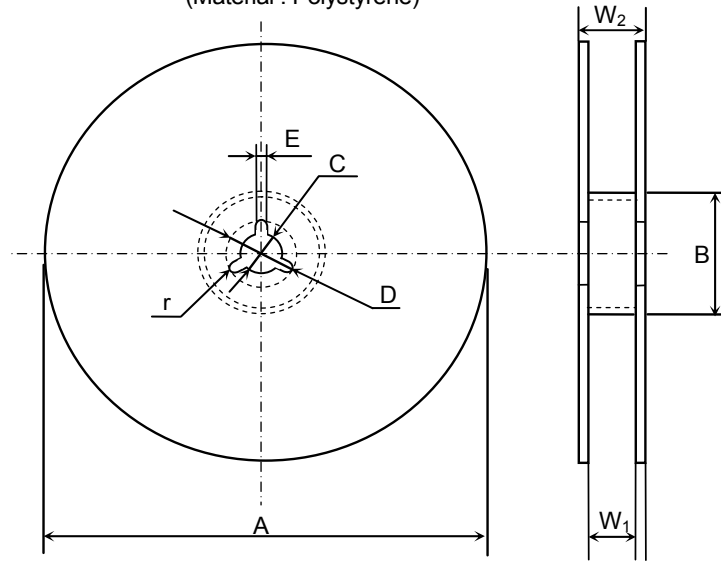

(Unit : mm)

Symbol	A	B	C	D	E	W ₁
Dimension	Ø178 ± 2.0	Ø60 ± 2.0	Ø13 ± 0.5	Ø21 ± 0.8	2.0 ± 0.5	9.0 ± 0.3
Symbol	W ₂	r				
Dimension	13.0 ± 1.4	1.0				

Appendix 8

CGJ6 (Applied to 2.5mm thickness products)

(Material : Polystyrene)

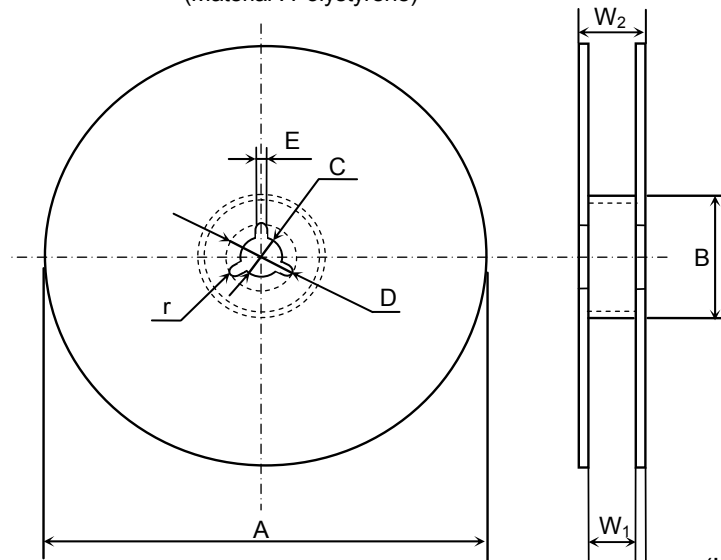

(Unit : mm)

Symbol	A	B	C	D	E	W ₁
Dimension	Ø178 ± 2.0	Ø60 ± 2.0	Ø13 ± 0.5	Ø21 ± 0.8	2.0 ± 0.5	13.0 ± 0.3
Symbol	W ₂	r				
Dimension	17.0 ± 1.4	1.0				

Appendix 9

CGJ2, CGJ3, CGJ4, CGJ5, CGJ6 (As for CGJ6 type, any thickness of the item except 2.5mm)

(Material : Polystyrene)

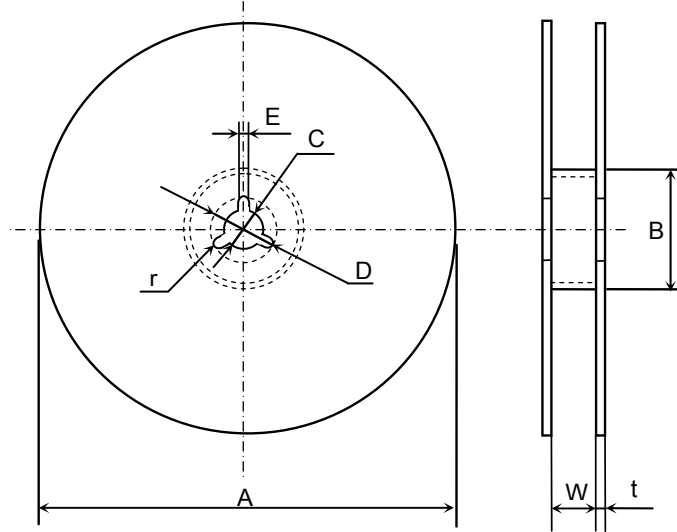

(Unit : mm)

Symbol	A	B	C	D	E	W
Dimension	Ø382 max. (Nominal Ø330)	Ø50 min.	Ø13 ± 0.5	Ø21 ± 0.8	2.0 ± 0.5	10.0 ± 1.5
Symbol	t	r				
Dimension	2.0 ± 0.5	1.0				

Appendix 10

CGJ6 (Applied to 2.5mm thickness products)

(Material : Polystyrene)

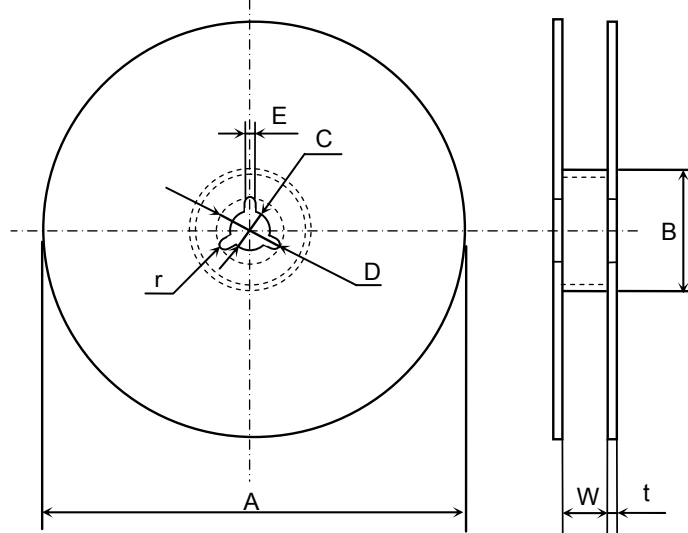

(Unit : mm)

Symbol	A	B	C	D	E	W
Dimension	Ø382 max. (Nominal Ø330)	Ø50 min.	Ø13 ± 0.5	Ø21 ± 0.8	2.0 ± 0.5	14.0 ± 1.5
Symbol	t	r				
Dimension	2.0 ± 0.5	1.0				

