

# Small Signal MOSFET

## 60 V, 380 mA, Single, N-Channel, SOT-23

### 2N7002K, 2V7002K

#### Features

- ESD Protected
- Low  $R_{DS(on)}$
- Surface Mount Package
- 2V Prefix for Automotive and Other Applications Requiring Unique Site and Control Change Requirements; AEC-Q101 Qualified and PPAP Capable
- These Devices are Pb-Free, Halogen Free/BFR Free and are RoHS Compliant

#### Applications

- Low Side Load Switch
- Level Shift Circuits
- DC-DC Converter
- Portable Applications i.e. DSC, PDA, Cell Phone, etc.

#### MAXIMUM RATINGS ( $T_J = 25^\circ\text{C}$ unless otherwise stated)

Rating	Symbol	Value	Unit
Drain-to-Source Voltage	$V_{DSS}$	60	V
Gate-to-Source Voltage	$V_{GS}$	$\pm 20$	V
Drain Current (Note 1) Steady State 1 sq in Pad	$I_D$	$T_A = 25^\circ\text{C}$ 380	mA
		$T_A = 85^\circ\text{C}$ 270	
Drain Current (Note 2) Steady State Minimum Pad	$I_D$	$T_A = 25^\circ\text{C}$ 320	mA
		$T_A = 85^\circ\text{C}$ 230	
Power Dissipation Steady State 1 sq in Pad Steady State Minimum Pad	$P_D$	420	mW
		300	
Pulsed Drain Current ( $t_p = 10 \mu\text{s}$ )	$I_{DM}$	5.0	A
Operating Junction and Storage Temperature Range	$T_J, T_{STG}$	-55 to +150	$^\circ\text{C}$
Source Current (Body Diode)	$I_S$	300	mA
Lead Temperature for Soldering Purposes (1/8" from case for 10 s)	$T_L$	260	$^\circ\text{C}$
Gate-Source ESD Rating (HBM, Method 3015)	ESD	2000	V

Stresses exceeding those listed in the Maximum Ratings table may damage the device. If any of these limits are exceeded, device functionality should not be assumed, damage may occur and reliability may be affected.

1. Surface-mounted on FR4 board using 1 sq in pad size with 1 oz Cu.
2. Surface-mounted on FR4 board using 0.08 sq in pad size with 1 oz Cu.

$V_{(BR)DSS}$	$R_{DS(on)}$ MAX	$I_D$ MAX
60 V	1.6 $\Omega$ @ 10 V	380 mA
	2.5 $\Omega$ @ 4.5 V	

#### SIMPLIFIED SCHEMATIC

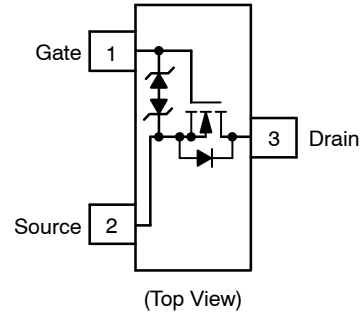

#### MARKING DIAGRAM & PIN ASSIGNMENT

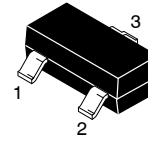

SOT-23  
CASE 318  
STYLE 21

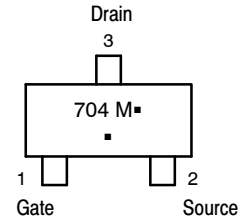

704 = Specific Device Code\*  
M = Date Code\*  
▪ = Pb-Free Package

(Note: Microdot may be in either location)  
\*Specific Device Code, Date Code or overbar orientation and/or location may vary depending upon manufacturing location. This is a representation only and actual devices may not match this drawing exactly.

#### ORDERING INFORMATION

Device	Package	Shipping†
2N7002KT1G, 2V7002KT1G	SOT-23 (Pb-Free)	3000 / Tape & Reel
2N7002KT7G	SOT-23 (Pb-Free)	3500 / Tape & Reel

†For information on tape and reel specifications, including part orientation and tape sizes, please refer to our Tape and Reel Packaging Specifications Brochure, BRD8011/D.

## 2N7002K, 2V7002K

### THERMAL CHARACTERISTICS

Characteristic	Symbol	Max	Unit
Junction-to-Ambient – Steady State (Note 3)	$R_{\theta JA}$	300	°C/W
Junction-to-Ambient – $t \leq 5$ s (Note 3)		92	
Junction-to-Ambient – Steady State (Note 4)		417	
Junction-to-Ambient – $t \leq 5$ s (Note 4)		154	

3. Surface-mounted on FR4 board using 1 sq in pad size with 1 oz Cu.  
 4. Surface-mounted on FR4 board using 0.08 sq in pad size with 1 oz Cu.

### ELECTRICAL CHARACTERISTICS ( $T_J = 25^\circ\text{C}$ unless otherwise specified)

Parameter	Symbol	Test Condition	Min	Typ	Max	Unit
-----------	--------	----------------	-----	-----	-----	------

#### OFF CHARACTERISTICS

Drain-to-Source Breakdown Voltage	$V_{(BR)DSS}$	$V_{GS} = 0$ V, $I_D = 250$ $\mu$ A	60			V
Drain-to-Source Breakdown Voltage Temperature Coefficient	$V_{(BR)DSS}/T_J$			71		mV/°C
Zero Gate Voltage Drain Current	$I_{DSS}$	$V_{GS} = 0$ V, $V_{DS} = 60$ V	$T_J = 25^\circ\text{C}$		1	$\mu$ A
			$T_J = 125^\circ\text{C}$		10	
		$V_{GS} = 0$ V, $V_{DS} = 50$ V	$T_J = 25^\circ\text{C}$		100	nA
Gate-to-Source Leakage Current	$I_{GSS}$	$V_{DS} = 0$ V, $V_{GS} = \pm 20$ V			$\pm 10$	$\mu$ A
		$V_{DS} = 0$ V, $V_{GS} = \pm 10$ V			450	nA
		$V_{DS} = 0$ V, $V_{GS} = \pm 5.0$ V			150	nA

#### ON CHARACTERISTICS (Note 5)

Gate Threshold Voltage	$V_{GS(TH)}$	$V_{GS} = V_{DS}$ , $I_D = 250$ $\mu$ A	1.0		2.3	V
Negative Threshold Temperature Coefficient	$V_{GS(TH)}/T_J$			4.0		mV/°C
Drain-to-Source On Resistance	$R_{DS(on)}$	$V_{GS} = 10$ V, $I_D = 500$ mA		1.19	1.6	$\Omega$
		$V_{GS} = 4.5$ V, $I_D = 200$ mA		1.33	2.5	
Forward Transconductance	$g_{FS}$	$V_{DS} = 5$ V, $I_D = 200$ mA		530		mS

#### CHARGES AND CAPACITANCES

Input Capacitance	$C_{ISS}$	$V_{GS} = 0$ V, $f = 1$ MHz, $V_{DS} = 20$ V		24.5	45	pF
Output Capacitance	$C_{OSS}$			4.2	8.0	
Reverse Transfer Capacitance	$C_{RSS}$			2.2	5.0	
Total Gate Charge	$Q_{G(TOT)}$	$V_{GS} = 4.5$ V, $V_{DS} = 10$ V; $I_D = 200$ mA		0.7		nC
Threshold Gate Charge	$Q_{G(TH)}$			0.1		
Gate-to-Source Charge	$Q_{GS}$			0.3		
Gate-to-Drain Charge	$Q_{GD}$			0.1		

#### SWITCHING CHARACTERISTICS, $V_{GS} = V$ (Note 6)

Turn-On Delay Time	$t_{d(ON)}$	$V_{GS} = 10$ V, $V_{DD} = 25$ V, $I_D = 500$ mA, $R_G = 25$ $\Omega$		12.2		ns
Rise Time	$t_r$			9.0		
Turn-Off Delay Time	$t_{d(OFF)}$			55.8		
Fall Time	$t_f$			29		

#### DRAIN-SOURCE DIODE CHARACTERISTICS

Forward Diode Voltage	$V_{SD}$	$V_{GS} = 0$ V, $I_S = 200$ mA	$T_J = 25^\circ\text{C}$		0.8	1.2	V
			$T_J = 85^\circ\text{C}$		0.7		

Product parametric performance is indicated in the Electrical Characteristics for the listed test conditions, unless otherwise noted. Product performance may not be indicated by the Electrical Characteristics if operated under different conditions.

5. Pulse Test: pulse width  $\leq 300$   $\mu$ s, duty cycle  $\leq 2\%$   
 6. Switching characteristics are independent of operating junction temperatures

TYPICAL CHARACTERISTICS

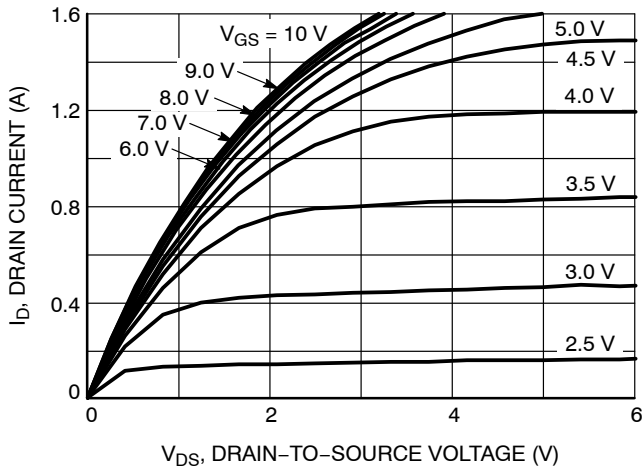

Figure 1. On-Region Characteristics

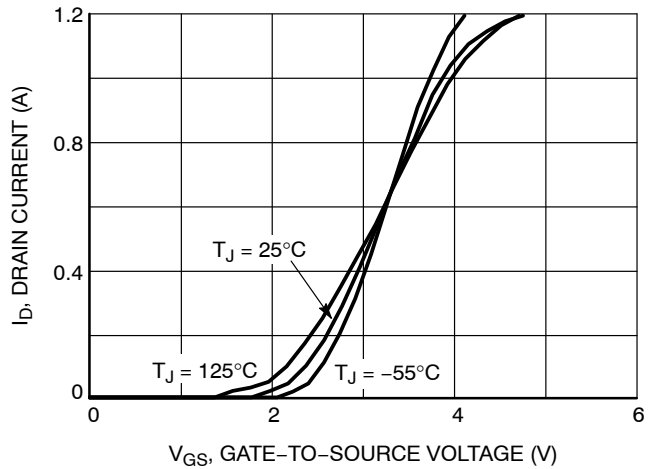

Figure 2. Transfer Characteristics

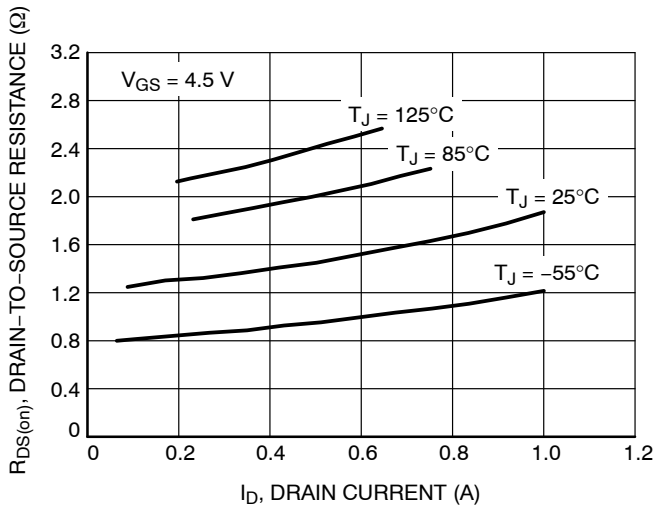

Figure 3. On-Resistance vs. Drain Current and Temperature

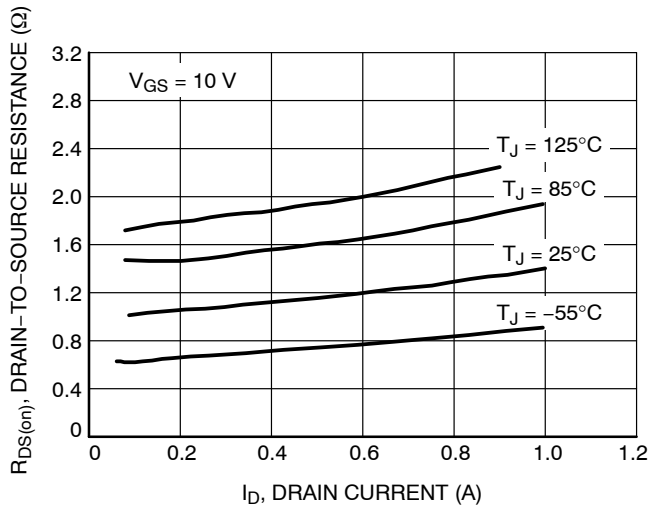

Figure 4. On-Resistance vs. Drain Current and Temperature

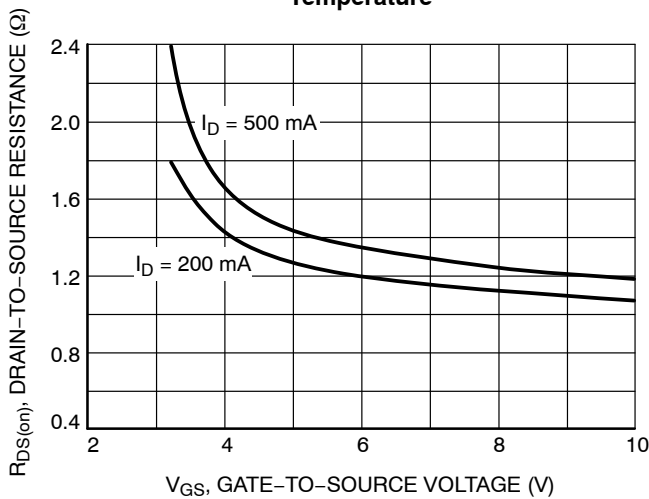

Figure 5. On-Resistance vs. Gate-to-Source Voltage

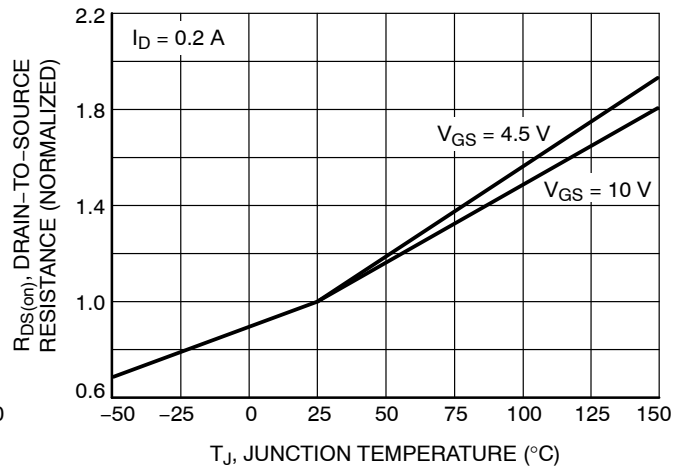
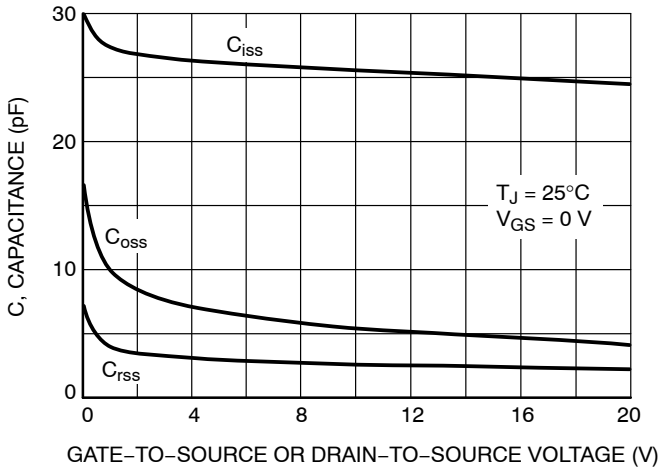

Figure 6. On-Resistance Variation with Temperature

# 2N7002K, 2V7002K

## TYPICAL CHARACTERISTICS



**Figure 7. Capacitance Variation**

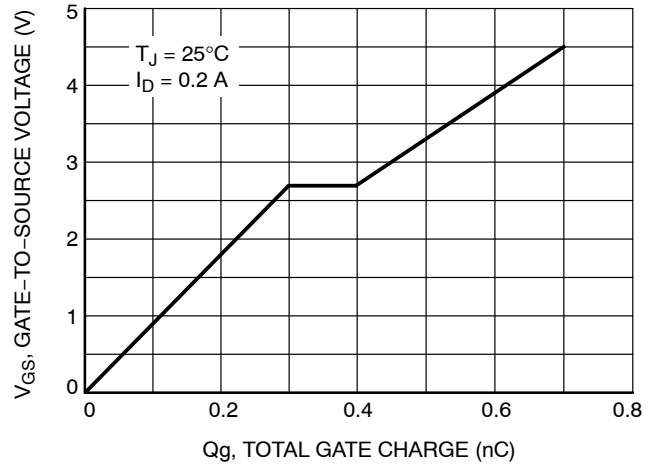

**Figure 8. Gate-to-Source and Drain-to-Source Voltage vs. Total Charge**

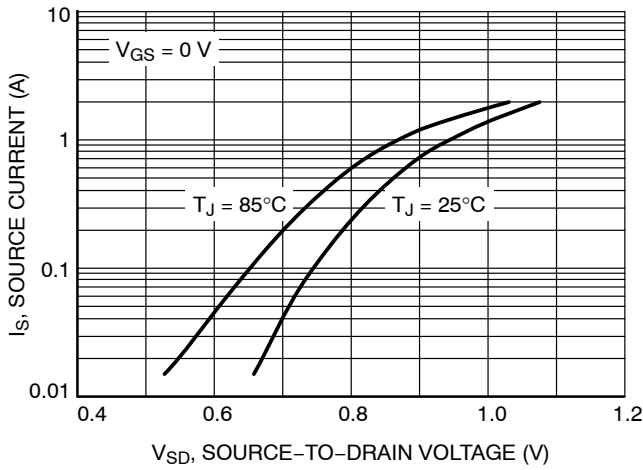

**Figure 9. Diode Forward Voltage vs. Current**

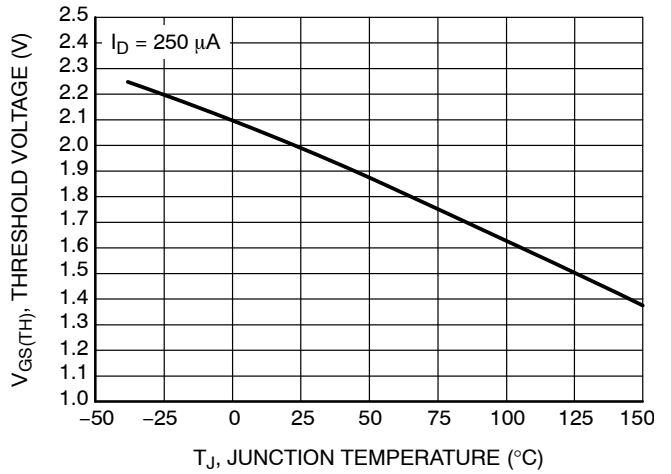

**Figure 10. Threshold Voltage with Temperature**

# 2N7002K, 2V7002K

## TYPICAL CHARACTERISTICS

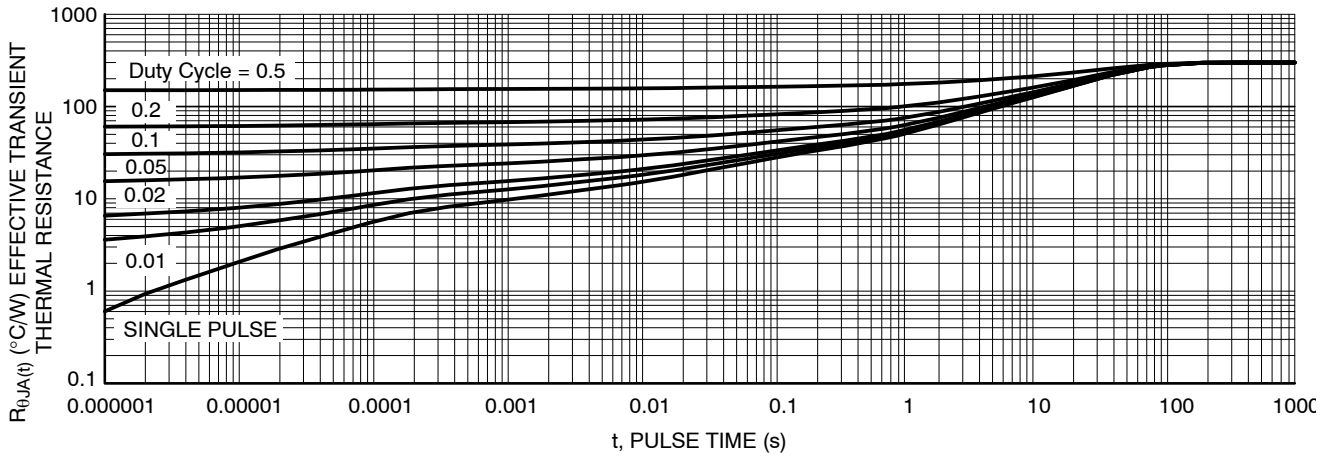

Figure 11. Thermal Response - 1 sq in pad

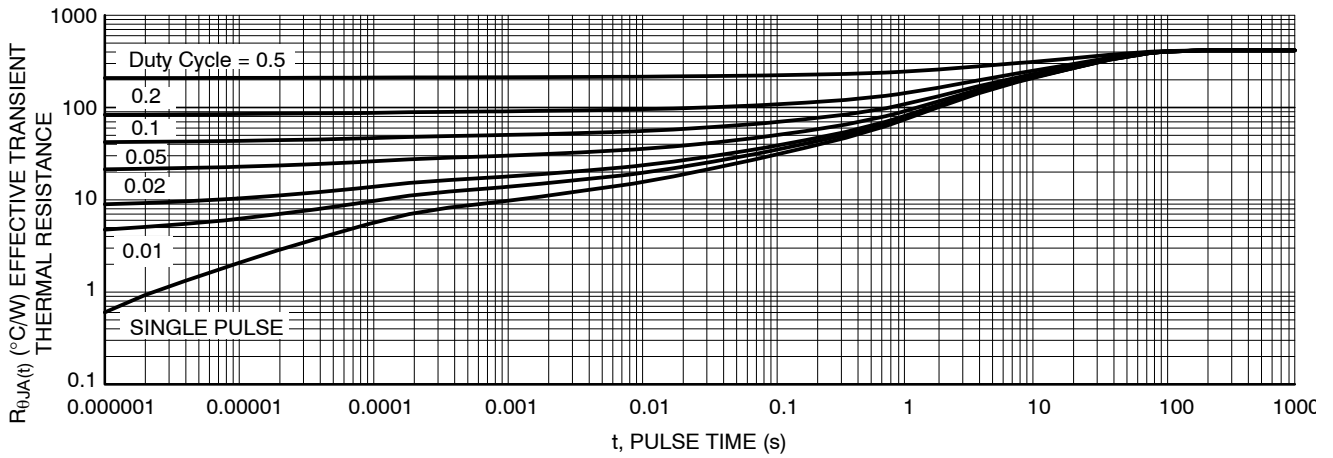

Figure 12. Thermal Response - minimum pad

# MECHANICAL CASE OUTLINE

## PACKAGE DIMENSIONS

ON Semiconductor®



**SOT-23 (TO-236)**  
CASE 318-08  
ISSUE AS

DATE 30 JAN 2018

SCALE 4:1



**NOTES:**

1. DIMENSIONING AND TOLERANCING PER ASME Y14.5M, 1994.
2. CONTROLLING DIMENSION: MILLIMETERS.
3. MAXIMUM LEAD THICKNESS INCLUDES LEAD FINISH. MINIMUM LEAD THICKNESS IS THE MINIMUM THICKNESS OF THE BASE MATERIAL.
4. DIMENSIONS D AND E DO NOT INCLUDE MOLD FLASH, PROTRUSIONS, OR GATE BURRS.

DIM	MILLIMETERS			INCHES		
	MIN	NOM	MAX	MIN	NOM	MAX
A	0.89	1.00	1.11	0.035	0.039	0.044
A1	0.01	0.06	0.10	0.000	0.002	0.004
b	0.37	0.44	0.50	0.015	0.017	0.020
c	0.08	0.14	0.20	0.003	0.006	0.008
D	2.80	2.90	3.04	0.110	0.114	0.120
E	1.20	1.30	1.40	0.047	0.051	0.055
e	1.78	1.90	2.04	0.070	0.075	0.080
L	0.30	0.43	0.55	0.012	0.017	0.022
L1	0.35	0.54	0.69	0.014	0.021	0.027
HE	2.10	2.40	2.64	0.083	0.094	0.104
T	0°	---	10°	0°	---	10°

**RECOMMENDED SOLDERING FOOTPRINT**



**GENERIC MARKING DIAGRAM\***



XXX = Specific Device Code  
M = Date Code  
▪ = Pb-Free Package

\*This information is generic. Please refer to device data sheet for actual part marking. Pb-Free indicator, "G" or microdot "▪", may or may not be present.

STYLE 1 THRU 5:  
CANCELLED

STYLE 6:  
PIN 1. BASE  
2. EMITTER  
3. COLLECTOR

STYLE 7:  
PIN 1. EMITTER  
2. BASE  
3. COLLECTOR

STYLE 8:  
PIN 1. ANODE  
2. NO CONNECTION  
3. CATHODE

STYLE 9:  
PIN 1. ANODE  
2. ANODE  
3. CATHODE

STYLE 10:  
PIN 1. DRAIN  
2. SOURCE  
3. GATE

STYLE 11:  
PIN 1. ANODE  
2. CATHODE  
3. CATHODE-ANODE

STYLE 12:  
PIN 1. CATHODE  
2. CATHODE  
3. ANODE

STYLE 13:  
PIN 1. SOURCE  
2. DRAIN  
3. GATE

STYLE 14:  
PIN 1. CATHODE  
2. GATE  
3. ANODE

STYLE 15:  
PIN 1. GATE  
2. CATHODE  
3. ANODE

STYLE 16:  
PIN 1. ANODE  
2. CATHODE  
3. CATHODE

STYLE 17:  
PIN 1. NO CONNECTION  
2. ANODE  
3. CATHODE

STYLE 18:  
PIN 1. NO CONNECTION  
2. CATHODE  
3. ANODE

STYLE 19:  
PIN 1. CATHODE  
2. ANODE  
3. CATHODE-ANODE

STYLE 20:  
PIN 1. CATHODE  
2. ANODE  
3. GATE

STYLE 21:  
PIN 1. GATE  
2. SOURCE  
3. DRAIN

STYLE 22:  
PIN 1. RETURN  
2. OUTPUT  
3. INPUT

STYLE 23:  
PIN 1. ANODE  
2. ANODE  
3. CATHODE

STYLE 24:  
PIN 1. GATE  
2. DRAIN  
3. SOURCE

STYLE 25:  
PIN 1. ANODE  
2. CATHODE  
3. GATE

STYLE 26:  
PIN 1. CATHODE  
2. ANODE  
3. NO CONNECTION

STYLE 27:  
PIN 1. CATHODE  
2. CATHODE  
3. CATHODE

STYLE 28:  
PIN 1. ANODE  
2. ANODE  
3. ANODE

<b>DOCUMENT NUMBER:</b>	<b>98ASB42226B</b>	Electronic versions are uncontrolled except when accessed directly from the Document Repository. Printed versions are uncontrolled except when stamped "CONTROLLED COPY" in red.
<b>DESCRIPTION:</b>	<b>SOT-23 (TO-236)</b>	<b>PAGE 1 OF 1</b>

ON Semiconductor and are trademarks of Semiconductor Components Industries, LLC dba ON Semiconductor or its subsidiaries in the United States and/or other countries. ON Semiconductor reserves the right to make changes without further notice to any products herein. ON Semiconductor makes no warranty, representation or guarantee regarding the suitability of its products for any particular purpose, nor does ON Semiconductor assume any liability arising out of the application or use of any product or circuit, and specifically disclaims any and all liability, including without limitation special, consequential or incidental damages. ON Semiconductor does not convey any license under its patent rights nor the rights of others.

**onsemi**, **Onsemi**, and other names, marks, and brands are registered and/or common law trademarks of Semiconductor Components Industries, LLC dba "**onsemi**" or its affiliates and/or subsidiaries in the United States and/or other countries. **onsemi** owns the rights to a number of patents, trademarks, copyrights, trade secrets, and other intellectual property. A listing of **onsemi**'s product/patent coverage may be accessed at [www.onsemi.com/site/pdf/Patent-Marking.pdf](http://www.onsemi.com/site/pdf/Patent-Marking.pdf). **onsemi** reserves the right to make changes at any time to any products or information herein, without notice. The information herein is provided "as-is" and **onsemi** makes no warranty, representation or guarantee regarding the accuracy of the information, product features, availability, functionality, or suitability of its products for any particular purpose, nor does **onsemi** assume any liability arising out of the application or use of any product or circuit, and specifically disclaims any and all liability, including without limitation special, consequential or incidental damages. Buyer is responsible for its products and applications using **onsemi** products, including compliance with all laws, regulations and safety requirements or standards, regardless of any support or applications information provided by **onsemi**. "Typical" parameters which may be provided in **onsemi** data sheets and/or specifications can and do vary in different applications and actual performance may vary over time. All operating parameters, including "Typicals" must be validated for each customer application by customer's technical experts. **onsemi** does not convey any license under any of its intellectual property rights nor the rights of others. **onsemi** products are not designed, intended, or authorized for use as a critical component in life support systems or any FDA Class 3 medical devices or medical devices with a same or similar classification in a foreign jurisdiction or any devices intended for implantation in the human body. Should Buyer purchase or use **onsemi** products for any such unintended or unauthorized application, Buyer shall indemnify and hold **onsemi** and its officers, employees, subsidiaries, affiliates, and distributors harmless against all claims, costs, damages, and expenses, and reasonable attorney fees arising out of, directly or indirectly, any claim of personal injury or death associated with such unintended or unauthorized use, even if such claim alleges that **onsemi** was negligent regarding the design or manufacture of the part. **onsemi** is an Equal Opportunity/Affirmative Action Employer. This literature is subject to all applicable copyright laws and is not for resale in any manner.

## PUBLICATION ORDERING INFORMATION

### LITERATURE FULFILLMENT:

Email Requests to: [orderlit@onsemi.com](mailto:orderlit@onsemi.com)

**onsemi Website:** [www.onsemi.com](http://www.onsemi.com)

### TECHNICAL SUPPORT

**North American Technical Support:**

Voice Mail: 1 800-282-9855 Toll Free USA/Canada

Phone: 011 421 33 790 2910

**Europe, Middle East and Africa Technical Support:**

Phone: 00421 33 790 2910

For additional information, please contact your local Sales Representative