

## Aluminum Electrolytic Capacitors SMD (Chip), Very Low Z

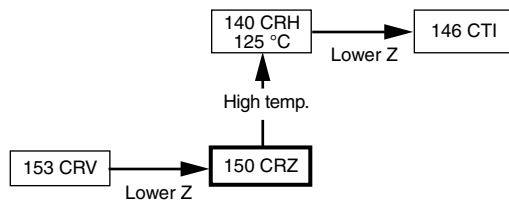

Fig. 1

 AUTOMOTIVE  
GRADE

**RoHS**  
COMPLIANT

### FEATURES

- Extended useful life: up to 10 000 h at 105 °C for MAL215099...E3 parts
- Polarized aluminum electrolytic capacitors, non-solid electrolyte, self healing
- SMD-version with base plate, lead (Pb)-free reflow solderable
- Very low impedance, very high ripple current
- Charge and discharge proof, no peak current limitation
- Parts for advanced high temperature reflow soldering according to JEDEC® J-STD-020
- Vibration proof, 4-pin version and 6-pin version
- AEC-Q200 qualified
- High reliability
- Low ESR
- Material categorization: for definitions of compliance please see [www.vishay.com/doc?99912](http://www.vishay.com/doc?99912)

### APPLICATIONS

- SMD technology, for high temperature reflow soldering
- Industrial and professional applications
- Automotive, general industrial, telecom
- Smoothing, filtering, buffering

### MARKING

- Rated capacitance (in  $\mu\text{F}$ )
- Rated voltage (in V)
- Date code, in accordance with IEC 60062
- Black mark or “-” sign indicating the cathode (the anode is identified by bevelled edges)
- Code indicating group number (Z)

### PACKAGING

Supplied in blister tape on reel

| QUICK REFERENCE DATA                         |   |
|--|---|
| DESCRIPTION                                  | VALUE                                     |
| Nominal case sizes<br>(L x W x H in mm)      | 8 x 8 x 10<br>to 18 x 18 x 21             |
| Rated capacitance range, $C_R$               | 4.7 $\mu\text{F}$ to 10 000 $\mu\text{F}$ |
| Tolerance on $C_R$                           | $\pm 20\%$                                |
| Rated voltage range, $U_R$                   | 6.3 V to 100 V                            |
| Category temperature range                   |   |
| 6.3 V to 63 V:                               | -55 °C to +105 °C                         |
| 80 V to 100 V:                               | -40 °C to +105 °C                         |
| Endurance test at 105 °C                     | 2000 h to 8000 h                          |
| Useful life at 105 °C                        | 2500 h to 10 000 h                        |
| Useful life at 40 °C;<br>1.8 x $I_R$ applied | 125 000 h to 500 000 h                    |
| Shelf life at 0 V, 105 °C                    | 1000 h                                    |
| Based on sectional<br>specification          | IEC 60384-18 / CECC 32300                 |
| Climatic category IEC 60068                  |   |
| 6.3 V to 63 V:                               | 55 / 105 / 56                             |
| 80 V to 100 V:                               | 40 / 105 / 56                             |

| SELECTION CHART FOR $C_R$ , $U_R$ , AND RELEVANT NOMINAL CASE SIZES (L x W x H in mm) |                  |                  |                  |                  |                  |                  |                  |                  |                  |
|---|------------------|------------------|------------------|------------------|------------------|------------------|------------------|------------------|------------------|
| $C_R$<br>( $\mu F$ )  | $U_R$ (V)        |                  |                  |                  |                  |                  |                  |                  |                  |
|   | 6.3              | 10               | 16               | 25               | 35               | 50               | 63               | 80               | 100              |
| 4.7   | →                | →                | →                | →                | →                | →                | →                | →                | 10 x 10 x 10     |
| 10  | →                | →                | →                | →                | →                | →                | →                | →                | 10 x 10 x 10     |
| 22  | →                | →                | →                | →                | →                | →                | →                | →                | 10 x 10 x 10     |
| 33  | →                | →                | →                | →                | →                | →                | 8 x 8 x 10       | →                | 10 x 10 x 10     |
| 47  | →                | →                | →                | →                | →                | →                | 8 x 8 x 10       | 10 x 10 x 10     | 10 x 10 x 12     |
|   | →                | →                | →                | →                | →                | →                | 10 x 10 x 10     |                  | -                |
| 68  | →                | →                | →                | →                | →                | 8 x 8 x 10       | 10 x 10 x 10     | →                | 12.5 x 12.5 x 13 |
| 100   | →                | →                | →                | →                | 8 x 8 x 10       | 10 x 10 x 10     | 10 x 10 x 12     | 10 x 10 x 12     | 12.5 x 12.5 x 13 |
|   |                  |                  |                  |                  |                  |                  | 10 x 10 x 14     |                  | -                |
| 150   | →                | →                | →                | 8 x 8 x 10       | →                | →                | 12.5 x 12.5 x 13 | 12.5 x 12.5 x 13 | 12.5 x 12.5 x 16 |
| 220   | →                | →                | 8 x 8 x 10       | 8 x 8 x 10       | 10 x 10 x 10     | 10 x 10 x 12     | 12.5 x 12.5 x 13 | 12.5 x 12.5 x 16 | 16 x 16 x 16     |
|   |                  |                  |                  |                  |                  | 10 x 10 x 14     |                  |                  |                  |
| 330   | →                | 8 x 8 x 10       | 8 x 8 x 10       | 10 x 10 x 10     | 10 x 10 x 12     | 12.5 x 12.5 x 13 | 16 x 16 x 16     | 16 x 16 x 16     | 16 x 16 x 21     |
|   |                  |                  |                  |                  | 10 x 10 x 14     |                  |                  |                  | 18 x 18 x 16     |
| 470   | 8 x 8 x 10       | 8 x 8 x 10       | 10 x 10 x 10     | 10 x 10 x 12     | 12.5 x 12.5 x 13 | →                | 16 x 16 x 21     | 16 x 16 x 21     | 18 x 18 x 21     |
|   |                  |                  |                  | 10 x 10 x 14     |                  |                  |                  |                  | -                |
| 680   | →                | 10 x 10 x 10     | 10 x 10 x 12     | 12.5 x 12.5 x 13 | 12.5 x 12.5 x 16 | 16 x 16 x 16     | 18 x 18 x 21     | 18 x 18 x 21     | -                |
|   |                  |                  | 10 x 10 x 14     |                  |                  |                  |                  |                  | -                |
| 1000  | 10 x 10 x 10     | 10 x 10 x 12     | 12.5 x 12.5 x 13 | 12.5 x 12.5 x 16 | 16 x 16 x 16     | 16 x 16 x 21     | -                | -                | -                |
|   |                  | 10 x 10 x 14     |                  |                  |                  | 18 x 18 x 16     | -                | -                | -                |
| 1500  | →                | 12.5 x 12.5 x 13 | 12.5 x 12.5 x 16 | 16 x 16 x 16     | 16 x 16 x 21     | 18 x 18 x 21     | -                | -                | -                |
|   |                  |                  |                  |                  | 18 x 18 x 16     |                  | -                | -                | -                |
| 2200  | 12.5 x 12.5 x 13 | 12.5 x 12.5 x 16 | 16 x 16 x 16     | 16 x 16 x 21     | 18 x 18 x 21     | -                | -                | -                | -                |
|   |                  |                  |                  | 18 x 18 x 16     |                  | -                | -                | -                |                  |
| 3300  | →                | 16 x 16 x 16     | 16 x 16 x 21     | 18 x 18 x 21     | -                | -                | -                | -                | -                |
|   |                  |                  | 18 x 18 x 16     |                  | -                | -                | -                | -                |                  |
| 4700  | 16 x 16 x 16     | 16 x 16 x 21     | 18 x 18 x 21     | -                | -                | -                | -                | -                | -                |
|   |                  | 18 x 18 x 16     |                  | -                | -                | -                | -                | -                |                  |
| 6800  | 16 x 16 x 21     | 18 x 18 x 21     | -                | -                | -                | -                | -                | -                | -                |
|   | 18 x 18 x 16     |                  | -                | -                | -                | -                | -                | -                |                  |
| 10 000  | 18 x 18 x 21     | -                | -                | -                | -                | -                | -                | -                | -                |

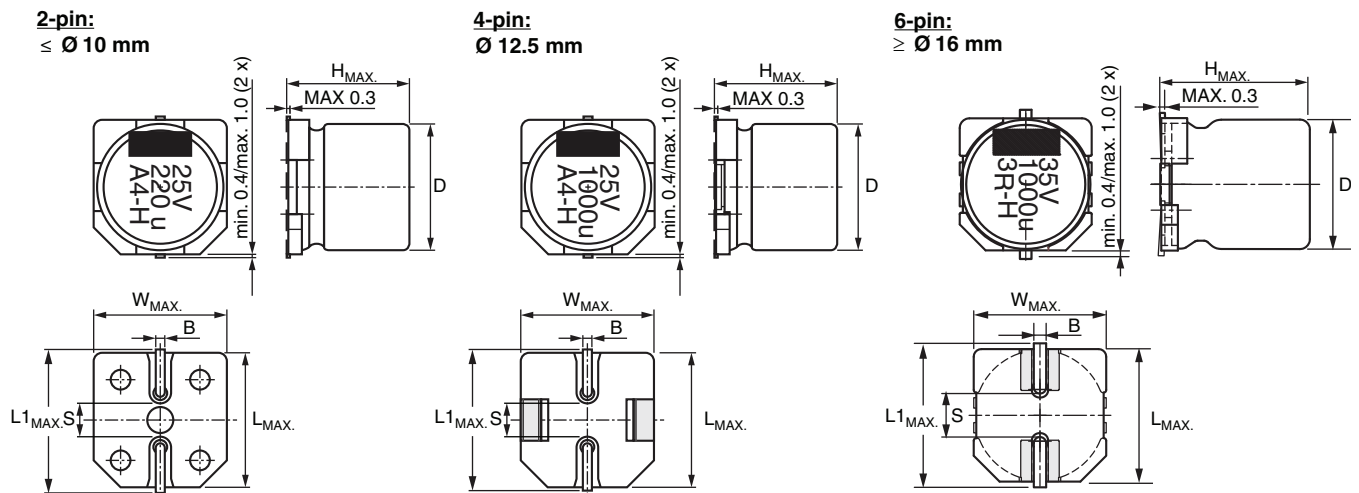

Fig. 2 - Dimensional outline



Table 1

| <b>DIMENSIONS</b> in millimeters <b>AND MASS</b> |           |                   |                   |                   |      |                   |     |                    |          |
|--|-----------|-------------------|-------------------|-------------------|------|-------------------|-----|--------------------|----------|
| NOMINAL CASE SIZE<br>L x W x H                   | CASE CODE | L <sub>MAX.</sub> | W <sub>MAX.</sub> | H <sub>MAX.</sub> | Ø D  | B <sub>MAX.</sub> | S   | L1 <sub>MAX.</sub> | MASS (g) |
| 8 x 8 x 10                                       | 0810      | 8.5               | 8.5               | 10.5              | 8.0  | 1.0               | 2.2 | 10.2               | ≈ 1.0    |
| 10 x 10 x 10                                     | 1010      | 10.5              | 10.5              | 10.5              | 10.0 | 1.0               | 3.5 | 12.1               | ≈ 1.3    |
| 10 x 10 x 12                                     | 1012      | 10.5              | 10.5              | 12.5              | 10.0 | 1.0               | 3.5 | 12.1               | ≈ 1.5    |
| 10 x 10 x 14                                     | 1014      | 10.5              | 10.5              | 14.3              | 10.0 | 1.0               | 3.5 | 12.1               | ≈ 1.5    |
| 12.5 x 12.5 x 13                                 | 1213      | 12.9              | 12.9              | 14.0              | 12.5 | 1.3               | 3.6 | 14.9               | ≈ 2.6    |
| 12.5 x 12.5 x 16                                 | 1216      | 12.9              | 12.9              | 16.5              | 12.5 | 1.3               | 3.6 | 14.9               | ≈ 2.8    |
| 16 x 16 x 16                                     | 1616      | 16.6              | 16.6              | 17.5              | 16.0 | 1.3               | 6.5 | 18.6               | ≈ 5.5    |
| 16 x 16 x 21                                     | 1621      | 16.6              | 16.6              | 22.0              | 16.0 | 1.3               | 6.5 | 18.6               | ≈ 6.0    |
| 18 x 18 x 16                                     | 1816      | 19.0              | 19.0              | 17.5              | 18.0 | 1.3               | 6.5 | 21.0               | ≈ 8.0    |
| 18 x 18 x 21                                     | 1821      | 19.0              | 19.0              | 22.0              | 18.0 | 1.3               | 6.5 | 21.0               | ≈ 8.3    |

Table 2

| <b>TAPE AND REEL DIMENSIONS</b> in millimeters, <b>PACKAGING QUANTITIES</b> |           |                         |                 |                                  |               |                                |
|---|-----------|-------------------------|-----------------|----------------------------------|---------------|--------------------------------|
| NOMINAL CASE SIZE<br>L x W x H  | CASE CODE | PITCH<br>P <sub>1</sub> | TAPE WIDTH<br>W | TAPE THICKNESS<br>T <sub>2</sub> | REEL DIAMETER | PACKAGING QUANTITY<br>PER REEL |
| 8 x 8 x 10  | 0810      | 16                      | 24              | 11.6                             | 380           | 500                            |
| 10 x 10 x 10  | 1010      | 16                      | 24              | 11.6                             | 380           | 500                            |
| 10 x 10 x 12  | 1012      | 16                      | 24              | 12.8                             | 330           | 250                            |
| 10 x 10 x 14  | 1014      | 16                      | 24              | 15.4                             | 330           | 250                            |
| 12.5 x 12.5 x 13  | 1213      | 20                      | 24              | 16.2                             | 380           | 250                            |
| 12.5 x 12.5 x 16  | 1216      | 24                      | 32              | 18.5                             | 380           | 200                            |
| 16 x 16 x 16  | 1616      | 28                      | 44              | 18.9                             | 380           | 150                            |
| 16 x 16 x 21  | 1621      | 28                      | 44              | 23.4                             | 380           | 100                            |
| 18 x 18 x 16  | 1816      | 32                      | 44              | 18.9                             | 380           | 125                            |
| 18 x 18 x 21  | 1821      | 32                      | 44              | 23.4                             | 380           | 100                            |

**Note**

- Detailed tape dimensions see section "PACKAGING".

**MOUNTING**

The capacitors are designed for automatic placement on to printed-circuit boards.

Optimum dimensions of soldering pads depend amongst others on soldering method, mounting accuracy, print layout and / or adjacent components. For recommended soldering pad dimensions, refer to Fig. 3 and Table 3.

**SOLDERING**

Soldering conditions are defined by the curve, temperature versus time, where the temperature is that measured on the component during processing.

For maximum conditions refer to Fig. 4 or Fig. 5.

Any temperature versus time curve which does not exceed the specified maximum curves may be applied.

As a general principle, temperature and duration shall be the **minimum** necessary required to ensure good soldering connections. However, the specified maximum curves should never be exceeded.

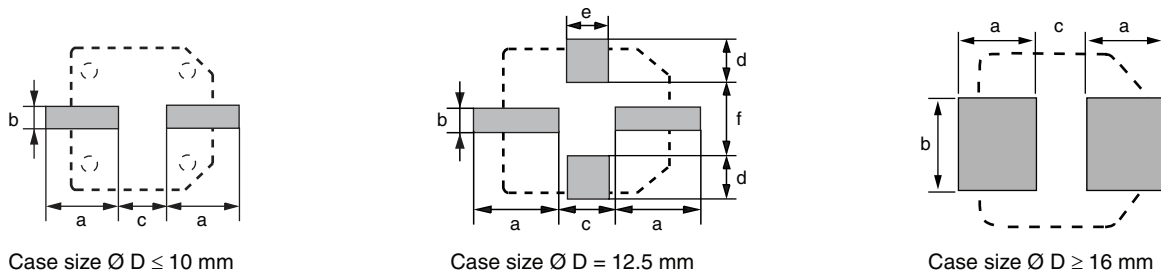

Fig. 3 - Recommended soldering pad dimensions

Table 3

| RECOMMENDED SOLDERING PAD DIMENSIONS in millimeters |     |     |     |     |     |     |
|---|-----|-----|-----|-----|-----|-----|
| CASE CODE   | a   | b   | c   | d   | e   | f   |
| 0810  | 4.4 | 2.5 | 3.0 | -   | -   | -   |
| 1010  | 4.4 | 2.5 | 4.0 | -   | -   | -   |
| 1012  | 4.4 | 2.5 | 4.0 | -   | -   | -   |
| 1014  | 4.4 | 2.5 | 4.0 | -   | -   | -   |
| 1213  | 6.3 | 2.5 | 4.0 | 4.2 | 5.0 | 5.6 |
| 1216  | 6.3 | 2.5 | 4.0 | 4.2 | 5.0 | 5.6 |
| 1616  | 7.8 | 9.6 | 4.7 | -   | -   | -   |
| 1621  | 7.8 | 9.6 | 4.7 | -   | -   | -   |
| 1816  | 8.8 | 9.6 | 4.7 | -   | -   | -   |
| 1821  | 8.8 | 9.6 | 4.7 | -   | -   | -   |

**STANDARD SOLDERING PROFILE FOR LEAD (Pb)-FREE REFLOW PROCESS**

Fig. 4 - Maximum temperature load during reflow soldering

**Table 4**

| <b>REFLOW SOLDERING CONDITIONS</b> for MAL215097xxxE3 |                                   |                                   |
|---|-----------------------------------|-----------------------------------|
| <b>PROFILE FEATURES</b>                               | <b>CASE CODE<br/>0810 TO 1014</b> | <b>CASE CODE<br/>1213 TO 1216</b> |
| Max. time from 25 °C to $T_{peak}$                    | 240 s                             | 200 s                             |
| Max. ramp-up rate to 150 °C                           | 3 K/s                             | 3 K/s                             |
| Max. time from 150 °C to 200 °C ( $t_1$ )             | 150 s                             | 120 s                             |
| Ramp up rate from 200 °C to $T_{peak}$                | 0.5 K/s to 3 K/s                  | 0.5 K/s to 3 K/s                  |
| Max. time from 200 °C to 217 °C ( $t_2$ )             | 60 s                              | 60 s                              |
| Max. time above $T_{Liquidus}$ (217 °C) ( $t_3$ )     | 90 s                              | 60 s                              |
| Max. time above 230 °C ( $t_4$ )                      | 40 s                              | 30 s                              |
| Peak temperature $T_{peak}$                           | 250 °C                            | 240 °C                            |
| Max. time above $T_{peak}$ minus 5 °C                 | 5 s                               | 10 s                              |
| Max. ramp-down rate from $T_{Liquidus}$               | 3 K/s to 6 K/s                    | 3 K/s to 6 K/s                    |

**Notes**

- Temperature measuring point on top of the case and on terminals.
- Max. 2 runs with pause of min. 30 min in between.

**ADVANCED SOLDERING PROFILE FOR LEAD (Pb)-FREE REFLOW PROCESS  
ACCORDING TO JEDEC J-STD-020**

Fig. 5 - Maximum temperature load during reflow soldering

Table 5

| REFLOW SOLDERING CONDITIONS for MAL215099xxxE3    |                           |                           |                           |
|---|---------------------------|---------------------------|---------------------------|
| PROFILE FEATURES                                  | CASE CODE<br>1010 TO 1012 | CASE CODE<br>1213 TO 1216 | CASE CODE<br>1616 TO 1821 |
| Max. time from 25 °C to $T_{Peak}$                | 300 s                     | 300 s                     | 300 s                     |
| Max. ramp-up rate to 150 °C                       | 3 K/s                     | 3 K/s                     | 3 K/s                     |
| Max. time from 150 °C to 200 °C ( $t_1$ )         | 150 s                     | 150 s                     | 150 s                     |
| Max. time from 190 °C to 200 °C ( $t_2$ )         | 110 s                     | 110 s                     | 110 s                     |
| Ramp up rate from 200 °C to $T_{Peak}$            | 0.5 K/s to 3 K/s          | 0.5 K/s to 3 K/s          | 0.5 K/s to 3 K/s          |
| Max. time above $T_{Liquidus}$ (217 °C) ( $t_3$ ) | 90 s                      | 90 s                      | 90 s                      |
| Max. time above 230 °C ( $t_4$ )                  | 70 s                      | 65 s                      | 60 s                      |
| Peak temperature $T_{Peak}$                       | 260 °C                    | 250 °C                    | 245 °C                    |
| Max. time above $T_{Peak}$ minus 5 °C             | 40 s                      | 30 s                      | 30 s                      |
| Ramp-down rate from $T_{Liquidus}$                | 3 K/s to 6 K/s            | 3 K/s to 6 K/s            | 3 K/s to 6 K/s            |

**Notes**

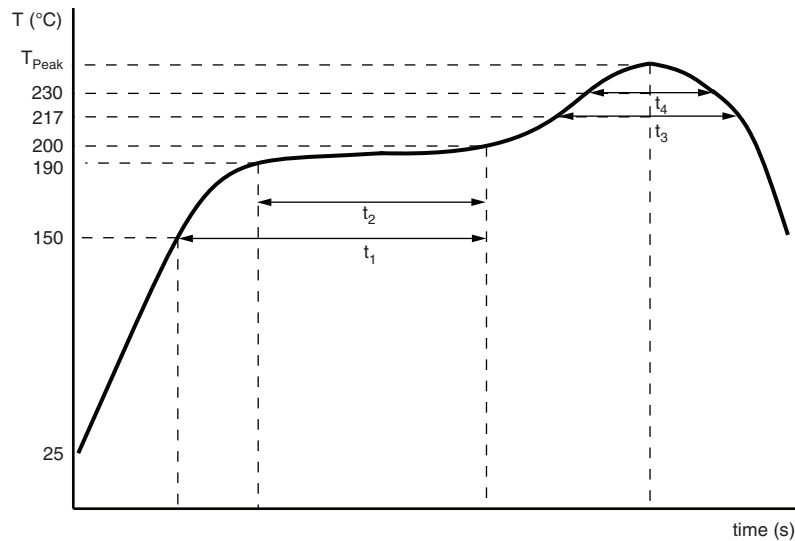
- Temperature measuring point on top of the case and on terminals.
- Max. 2 runs with pause of min. 30 min in between.



| ELECTRICAL DATA |   |
|-----------------|---|
| SYMBOL          | DESCRIPTION                                       |
| $C_R$           | Rated capacitance at 100 Hz, tolerance $\pm 20\%$ |
| $I_R$           | Rated RMS ripple current at 100 kHz, 105 °C       |
| $I_{L2}$        | Max. leakage current after 2 min at $U_R$         |
| $\tan \delta$   | Max. dissipation factor at 100 Hz                 |
| Z               | Max. impedance at 100 kHz                         |

**ORDERING EXAMPLE**

Electrolytic capacitor 150 CRZ series

470  $\mu\text{F}$  / 35 V;  $\pm 20\%$

Nominal case size: 12.5 mm x 12.5 mm x 13 mm; taped on reel

Ordering code: MAL215099012E3

**Note**

- Unless otherwise specified, all electrical values in Table 6 apply at  $T_{amb} = 20\text{ °C}$ ,  $P = 86\text{ kPa}$  to  $106\text{ kPa}$ ,  $RH = 45\%$  to  $75\%$

Table 6

| ELECTRICAL DATA AND ORDERING INFORMATION |                            |  |                                 |                                     |                         |                                       |  |                             |   |   |
|--|----------------------------|--|---------------------------------|-------------------------------------|-------------------------|---------------------------------------|--|-----------------------------|---|---|
| $U_R$<br>(V)                             | $C_R$<br>( $\mu\text{F}$ ) | NOMINAL CASE SIZE<br>L x W x H<br>(mm) | $I_R$ 105 °C<br>100 kHz<br>(mA) | $I_L$<br>2 min<br>( $\mu\text{A}$ ) | $\tan \delta$<br>100 Hz | Z<br>100 kHz<br>20 °C<br>( $\Omega$ ) | Z<br>100 kHz<br>-40 °C<br>( $\Omega$ ) | LIFE<br>CODE <sup>(3)</sup> | ORDERING<br>CODE <sup>(1)</sup><br>MAL2150... | ORDERING<br>CODE <sup>(2)</sup><br>MAL2150... |
| 6.3                                      | 470                        | 8 x 8 x 10                             | 435                             | 30                                  | 0.24                    | 0.250                                 | 2.00                                   | L1                          | 97311E3                                       | -   |
|  | 1000                       | 10 x 10 x 10                           | 670                             | 63                                  | 0.24                    | 0.130                                 | 1.10                                   | L2                          | 97301E3                                       | 99301E3                                       |
|  | 2200                       | 12.5 x 12.5 x 13                       | 905                             | 139                                 | 0.26                    | 0.077                                 | 0.60                                   | L3                          | 97312E3                                       | -   |
|  | 2200                       | 12.5 x 12.5 x 13                       | 905                             | 139                                 | 0.26                    | 0.077                                 | 0.60                                   | L4                          | -   | 99312E3                                       |
|  | 4700                       | 16 x 16 x 16                           | 1350                            | 296                                 | 0.28                    | 0.050                                 | 0.40                                   | L6                          | -   | 99313E3                                       |
|  | 6800                       | 16 x 16 x 21                           | 1666                            | 428                                 | 0.30                    | 0.035                                 | 0.28                                   | L6                          | -   | 99314E3                                       |
|  | 6800                       | 18 x 18 x 16                           | 1400                            | 428                                 | 0.32                    | 0.050                                 | 0.40                                   | L6                          | -   | 99315E3                                       |
|  | 10 000                     | 18 x 18 x 21                           | 1756                            | 630                                 | 0.34                    | 0.035                                 | 0.28                                   | L6                          | -   | 99316E3                                       |
| 10                                       | 330                        | 8 x 8 x 10                             | 435                             | 33                                  | 0.20                    | 0.250                                 | 2.00                                   | L1                          | 97411E3                                       | -   |
|  | 470                        | 8 x 8 x 10                             | 435                             | 47                                  | 0.20                    | 0.250                                 | 2.00                                   | L1                          | 97412E3                                       | -   |
|  | 680                        | 10 x 10 x 10                           | 670                             | 68                                  | 0.20                    | 0.130                                 | 1.10                                   | L2                          | 97401E3                                       | 99401E3                                       |
|  | 1000                       | 10 x 10 x 12                           | 850                             | 100                                 | 0.20                    | 0.100                                 | 0.80                                   | L2                          | -   | 99403E3                                       |
|  | 1000                       | 10 x 10 x 14                           | 850                             | 100                                 | 0.20                    | 0.100                                 | 0.80                                   | L2                          | 97402E3                                       | -   |
|  | 1500                       | 12.5 x 12.5 x 13                       | 905                             | 150                                 | 0.22                    | 0.077                                 | 0.60                                   | L3                          | 97413E3                                       | -   |
|  | 1500                       | 12.5 x 12.5 x 13                       | 905                             | 150                                 | 0.22                    | 0.077                                 | 0.60                                   | L4                          | -   | 99413E3                                       |
|  | 2200                       | 12.5 x 12.5 x 16                       | 1007                            | 220                                 | 0.22                    | 0.060                                 | 0.48                                   | L3                          | 97414E3                                       | -   |
|  | 2200                       | 12.5 x 12.5 x 16                       | 1007                            | 220                                 | 0.22                    | 0.060                                 | 0.48                                   | L5                          | -   | 99414E3                                       |
|  | 3300                       | 16 x 16 x 16                           | 1350                            | 330                                 | 0.24                    | 0.050                                 | 0.40                                   | L6                          | -   | 99415E3                                       |
|  | 4700                       | 16 x 16 x 21                           | 1666                            | 470                                 | 0.26                    | 0.035                                 | 0.28                                   | L6                          | -   | 99416E3                                       |
|  | 4700                       | 18 x 18 x 16                           | 1400                            | 470                                 | 0.26                    | 0.050                                 | 0.40                                   | L6                          | -   | 99417E3                                       |
|  | 6800                       | 18 x 18 x 21                           | 1756                            | 680                                 | 0.28                    | 0.035                                 | 0.28                                   | L6                          | -   | 99418E3                                       |
| 16                                       | 220                        | 8 x 8 x 10                             | 435                             | 35                                  | 0.16                    | 0.250                                 | 2.00                                   | L1                          | 97511E3                                       | -   |
|  | 330                        | 8 x 8 x 10                             | 435                             | 53                                  | 0.16                    | 0.250                                 | 2.00                                   | L1                          | 97512E3                                       | -   |
|  | 470                        | 10 x 10 x 10                           | 670                             | 75                                  | 0.16                    | 0.130                                 | 1.10                                   | L2                          | 97501E3                                       | 99501E3                                       |
|  | 680                        | 10 x 10 x 12                           | 850                             | 109                                 | 0.16                    | 0.100                                 | 0.80                                   | L2                          | -   | 99503E3                                       |
|  | 680                        | 10 x 10 x 14                           | 850                             | 109                                 | 0.16                    | 0.100                                 | 0.80                                   | L2                          | 97502E3                                       | -   |
|  | 1000                       | 12.5 x 12.5 x 13                       | 905                             | 160                                 | 0.18                    | 0.077                                 | 0.60                                   | L3                          | 97513E3                                       | -   |
|  | 1000                       | 12.5 x 12.5 x 13                       | 905                             | 160                                 | 0.18                    | 0.077                                 | 0.60                                   | L4                          | -   | 99513E3                                       |
|  | 1500                       | 12.5 x 12.5 x 16                       | 1007                            | 240                                 | 0.18                    | 0.060                                 | 0.48                                   | L3                          | 97514E3                                       | -   |
|  | 1500                       | 12.5 x 12.5 x 16                       | 1007                            | 240                                 | 0.18                    | 0.060                                 | 0.48                                   | L5                          | -   | 99514E3                                       |
|  | 2200                       | 16 x 16 x 16                           | 1350                            | 352                                 | 0.20                    | 0.050                                 | 0.40                                   | L6                          | -   | 99515E3                                       |
|  | 3300                       | 16 x 16 x 21                           | 1666                            | 528                                 | 0.22                    | 0.035                                 | 0.28                                   | L6                          | -   | 99516E3                                       |
|  | 3300                       | 18 x 18 x 16                           | 1400                            | 528                                 | 0.22                    | 0.050                                 | 0.40                                   | L6                          | -   | 99517E3                                       |
|  | 4700                       | 18 x 18 x 21                           | 1756                            | 752                                 | 0.26                    | 0.035                                 | 0.28                                   | L6                          | -   | 99518E3                                       |

**Notes**

- (1) Standard reflow soldering profile, see Fig. 4 and Table 4
- (2) Advanced reflow soldering profile, according to JEDEC J-STD-020, see Fig. 5 and Table 5
- (3) Determines the applicable row in the table "Endurance Test Duration and Useful Life"



| ELECTRICAL DATA AND ORDERING INFORMATION |                        |  |  |                                 |                 |                              |                               |                             |   |   |
|--|------------------------|--|--|---------------------------------|-----------------|------------------------------|-------------------------------|-----------------------------|---|---|
| U <sub>R</sub><br>(V)                    | C <sub>R</sub><br>(μF) | NOMINAL CASE SIZE<br>L x W x H<br>(mm) | I <sub>R</sub> 105 °C<br>100 kHz<br>(mA) | I <sub>L</sub><br>2 min<br>(μA) | tan δ<br>100 Hz | Z<br>100 kHz<br>20 °C<br>(Ω) | Z<br>100 kHz<br>-40 °C<br>(Ω) | LIFE<br>CODE <sup>(3)</sup> | ORDERING<br>CODE <sup>(1)</sup><br>MAL2150... | ORDERING<br>CODE <sup>(2)</sup><br>MAL2150... |
| 25                                       | 150                    | 8 x 8 x 10                             | 420                                      | 38                              | 0.14            | 0.280                        | 2.24                          | L1                          | 97611E3                                       | -   |
|  | 220                    | 8 x 8 x 10                             | 420                                      | 55                              | 0.14            | 0.280                        | 2.24                          | L1                          | 97612E3                                       | -   |
|  | 330                    | 10 x 10 x 10                           | 640                                      | 83                              | 0.14            | 0.140                        | 1.12                          | L2                          | 97601E3                                       | 99601E3                                       |
|  | 470                    | 10 x 10 x 12                           | 820                                      | 118                             | 0.14            | 0.110                        | 0.88                          | L2                          | -   | 99603E3                                       |
|  | 470                    | 10 x 10 x 14                           | 820                                      | 118                             | 0.14            | 0.110                        | 0.88                          | L2                          | 97602E3                                       | -   |
|  | 680                    | 12.5 x 12.5 x 13                       | 905                                      | 170                             | 0.16            | 0.077                        | 0.60                          | L3                          | 97613E3                                       | -   |
|  | 680                    | 12.5 x 12.5 x 13                       | 905                                      | 170                             | 0.16            | 0.077                        | 0.60                          | L4                          | -   | 99613E3                                       |
|  | 1000                   | 12.5 x 12.5 x 16                       | 1007                                     | 250                             | 0.16            | 0.060                        | 0.48                          | L3                          | 97614E3                                       | -   |
|  | 1000                   | 12.5 x 12.5 x 16                       | 1007                                     | 250                             | 0.16            | 0.060                        | 0.48                          | L5                          | -   | 99614E3                                       |
|  | 1500                   | 16 x 16 x 16                           | 1350                                     | 375                             | 0.16            | 0.050                        | 0.40                          | L6                          | -   | 99615E3                                       |
|  | 2200                   | 16 x 16 x 21                           | 1666                                     | 550                             | 0.18            | 0.035                        | 0.28                          | L6                          | -   | 99616E3                                       |
|  | 2200                   | 18 x 18 x 16                           | 1400                                     | 550                             | 0.18            | 0.050                        | 0.40                          | L6                          | -   | 99617E3                                       |
|  | 3300                   | 18 x 18 x 21                           | 1756                                     | 825                             | 0.20            | 0.035                        | 0.28                          | L6                          | -   | 99618E3                                       |
| 35                                       | 100                    | 8 x 8 x 10                             | 405                                      | 35                              | 0.12            | 0.300                        | 2.40                          | L1                          | 97011E3                                       | -   |
|  | 220                    | 10 x 10 x 10                           | 630                                      | 77                              | 0.12            | 0.150                        | 1.20                          | L2                          | 97001E3                                       | 99001E3                                       |
|  | 330                    | 10 x 10 x 12                           | 790                                      | 116                             | 0.12            | 0.120                        | 0.96                          | L2                          | -   | 99003E3                                       |
|  | 330                    | 10 x 10 x 14                           | 790                                      | 116                             | 0.12            | 0.120                        | 0.96                          | L2                          | 97002E3                                       | -   |
|  | 470                    | 12.5 x 12.5 x 13                       | 905                                      | 165                             | 0.14            | 0.077                        | 0.60                          | L3                          | 97012E3                                       | -   |
|  | 470                    | 12.5 x 12.5 x 13                       | 905                                      | 165                             | 0.14            | 0.077                        | 0.60                          | L4                          | -   | 99012E3                                       |
|  | 680                    | 12.5 x 12.5 x 16                       | 1007                                     | 238                             | 0.14            | 0.060                        | 0.48                          | L3                          | 97013E3                                       | -   |
|  | 680                    | 12.5 x 12.5 x 16                       | 1007                                     | 238                             | 0.14            | 0.060                        | 0.48                          | L5                          | -   | 99013E3                                       |
|  | 1000                   | 16 x 16 x 16                           | 1350                                     | 350                             | 0.14            | 0.050                        | 0.40                          | L6                          | -   | 99014E3                                       |
|  | 1500                   | 16 x 16 x 21                           | 1666                                     | 525                             | 0.14            | 0.035                        | 0.28                          | L6                          | -   | 99015E3                                       |
|  | 1500                   | 18 x 18 x 16                           | 1400                                     | 525                             | 0.14            | 0.050                        | 0.40                          | L6                          | -   | 99016E3                                       |
|  | 2200                   | 18 x 18 x 21                           | 1756                                     | 770                             | 0.16            | 0.035                        | 0.28                          | L6                          | -   | 99017E3                                       |
|  | 50                     | 68                                     | 8 x 8 x 10                               | 333                             | 34              | 0.12                         | 0.480                         | 3.84                        | L1  | 97111E3                                       |
| 100                                      |                        | 10 x 10 x 10                           | 490                                      | 50                              | 0.12            | 0.240                        | 1.92                          | L2                          | 97101E3                                       | 99101E3                                       |
| 220                                      |                        | 10 x 10 x 12                           | 620                                      | 110                             | 0.12            | 0.190                        | 1.52                          | L2                          | -   | 99103E3                                       |
| 220                                      |                        | 10 x 10 x 14                           | 620                                      | 110                             | 0.12            | 0.190                        | 1.52                          | L2                          | 97102E3                                       | -   |
| 330                                      |                        | 12.5 x 12.5 x 13                       | 690                                      | 165                             | 0.12            | 0.130                        | 1.04                          | L3                          | 97112E3                                       | -   |
| 330                                      |                        | 12.5 x 12.5 x 13                       | 690                                      | 165                             | 0.12            | 0.130                        | 1.04                          | L4                          | -   | 99112E3                                       |
| 680                                      |                        | 16 x 16 x 16                           | 1035                                     | 340                             | 0.12            | 0.085                        | 0.68                          | L6                          | -   | 99114E3                                       |
| 1000                                     |                        | 16 x 16 x 21                           | 1100                                     | 500                             | 0.12            | 0.080                        | 0.64                          | L6                          | -   | 99115E3                                       |
| 1000                                     |                        | 18 x 18 x 16                           | 1074                                     | 500                             | 0.12            | 0.085                        | 0.68                          | L6                          | -   | 99116E3                                       |
| 1500                                     |                        | 18 x 18 x 21                           | 1470                                     | 750                             | 0.12            | 0.080                        | 0.64                          | L6                          | -   | 99117E3                                       |
| 63                                       |                        | 33                                     | 8 x 8 x 10                               | 270                             | 21              | 0.10                         | 0.650                         | 5.20                        | L1  | 97812E3                                       |
|  | 47                     | 8 x 8 x 10                             | 270                                      | 30                              | 0.10            | 0.650                        | 5.20                          | L1                          | 97811E3                                       | -   |
|  | 47                     | 10 x 10 x 10                           | 390                                      | 30                              | 0.10            | 0.380                        | 3.00                          | L2                          | 97801E3                                       | 99801E3                                       |
|  | 68                     | 10 x 10 x 10                           | 390                                      | 43                              | 0.10            | 0.380                        | 3.00                          | L2                          | 97802E3                                       | 99802E3                                       |
|  | 100                    | 10 x 10 x 12                           | 507                                      | 63                              | 0.10            | 0.290                        | 2.32                          | L2                          | -   | 99804E3                                       |
|  | 100                    | 10 x 10 x 14                           | 507                                      | 63                              | 0.10            | 0.290                        | 2.32                          | L2                          | 97803E3                                       | -   |
|  | 150                    | 12.5 x 12.5 x 13                       | 507                                      | 97                              | 0.10            | 0.250                        | 2.00                          | L3                          | 97821E3                                       | -   |
|  | 150                    | 12.5 x 12.5 x 13                       | 507                                      | 97                              | 0.10            | 0.250                        | 2.00                          | L4                          | -   | 99821E3                                       |
|  | 220                    | 12.5 x 12.5 x 16                       | 637                                      | 141                             | 0.10            | 0.200                        | 1.60                          | L3                          | 97815E3                                       | -   |
|  | 220                    | 12.5 x 12.5 x 16                       | 637                                      | 141                             | 0.10            | 0.200                        | 1.60                          | L5                          | -   | 99815E3                                       |
|  | 330                    | 16 x 16 x 16                           | 910                                      | 208                             | 0.10            | 0.150                        | 1.20                          | L6                          | -   | 99816E3                                       |
|  | 470                    | 16 x 16 x 21                           | 987                                      | 296                             | 0.10            | 0.120                        | 0.96                          | L6                          | -   | 99817E3                                       |
|  | 470                    | 18 x 18 x 16                           | 944                                      | 296                             | 0.10            | 0.150                        | 1.20                          | L6                          | -   | 99818E3                                       |
|  | 680                    | 18 x 18 x 21                           | 1160                                     | 428                             | 0.10            | 0.120                        | 0.96                          | L6                          | -   | 99819E3                                       |

Notes

- (1) Standard reflow soldering profile, see Fig. 4 and Table 4
- (2) Advanced reflow soldering profile, according to JEDEC J-STD-020, see Fig. 5 and Table 5
- (3) Determines the applicable row in the table "Endurance Test Duration and Useful Life"





| ELECTRICAL DATA AND ORDERING INFORMATION |                        |  |  |                                 |                 |                              |                               |                             |   |   |
|--|------------------------|--|--|---------------------------------|-----------------|------------------------------|-------------------------------|-----------------------------|---|---|
| U <sub>R</sub><br>(V)                    | C <sub>R</sub><br>(μF) | NOMINAL CASE SIZE<br>L x W x H<br>(mm) | I <sub>R</sub> 105 °C<br>100 kHz<br>(mA) | I <sub>L</sub><br>2 min<br>(μA) | tan δ<br>100 Hz | Z<br>100 kHz<br>20 °C<br>(Ω) | Z<br>100 kHz<br>-40 °C<br>(Ω) | LIFE<br>CODE <sup>(3)</sup> | ORDERING<br>CODE <sup>(1)</sup><br>MAL2150... | ORDERING<br>CODE <sup>(2)</sup><br>MAL2150... |
| 80                                       | 47                     | 10 x 10 x 10                           | 240                                      | 38                              | 0.10            | 0.800                        | 6.40                          | L2                          | 97701E3                                       | 99701E3                                       |
|  | 100                    | 10 x 10 x 12                           | 300                                      | 80                              | 0.10            | 0.620                        | 4.96                          | L2                          | -   | 99702E3                                       |
|  | 150                    | 12.5 x 12.5 x 13                       | 670                                      | 120                             | 0.10            | 0.350                        | 2.80                          | L3                          | -   | 99703E3                                       |
|  | 220                    | 12.5 x 12.5 x 16                       | 750                                      | 176                             | 0.10            | 0.250                        | 2.00                          | L3                          | -   | 99704E3                                       |
|  | 330                    | 16 x 16 x 16                           | 1000                                     | 264                             | 0.10            | 0.180                        | 1.44                          | L3                          | -   | 99705E3                                       |
|  | 470                    | 16 x 16 x 21                           | 1400                                     | 376                             | 0.10            | 0.120                        | 0.96                          | L3                          | -   | 99706E3                                       |
|  | 470                    | 18 x 18 x 16                           | 1050                                     | 376                             | 0.10            | 0.160                        | 1.28                          | L3                          | -   | 99707E3                                       |
|  | 680                    | 18 x 18 x 21                           | 1450                                     | 544                             | 0.10            | 0.110                        | 0.88                          | L3                          | -   | 99708E3                                       |
| 100                                      | 4.7                    | 10 x 10 x 10                           | 210                                      | 5                               | 0.10            | 0.800                        | 6.40                          | L2                          | 97901E3                                       | -   |
|  | 10                     | 10 x 10 x 10                           | 240                                      | 10                              | 0.10            | 0.800                        | 6.40                          | L2                          | 97902E3                                       | 99902E3                                       |
|  | 22                     | 10 x 10 x 10                           | 240                                      | 22                              | 0.10            | 0.800                        | 6.40                          | L2                          | 97903E3                                       | 99903E3                                       |
|  | 33                     | 10 x 10 x 10                           | 250                                      | 33                              | 0.10            | 0.800                        | 6.40                          | L2                          | 97904E3                                       | 99904E3                                       |
|  | 47                     | 10 x 10 x 12                           | 270                                      | 47                              | 0.10            | 0.620                        | 4.96                          | L2                          | -   | 99905E3                                       |
|  | 68                     | 12.5 x 12.5 x 13                       | 660                                      | 68                              | 0.10            | 0.350                        | 2.80                          | L3                          | -   | 99906E3                                       |
|  | 100                    | 12.5 x 12.5 x 13                       | 660                                      | 100                             | 0.10            | 0.350                        | 2.80                          | L3                          | -   | 99907E3                                       |
|  | 150                    | 12.5 x 12.5 x 16                       | 750                                      | 150                             | 0.10            | 0.250                        | 2.00                          | L3                          | -   | 99908E3                                       |
|  | 220                    | 16 x 16 x 16                           | 1000                                     | 220                             | 0.10            | 0.180                        | 1.44                          | L3                          | -   | 99909E3                                       |
|  | 330                    | 16 x 16 x 21                           | 1400                                     | 330                             | 0.10            | 0.120                        | 0.96                          | L3                          | -   | 99911E3                                       |
|  | 330                    | 18 x 18 x 16                           | 1050                                     | 330                             | 0.10            | 0.160                        | 1.28                          | L3                          | -   | 99912E3                                       |
|  | 470                    | 18 x 18 x 21                           | 1450                                     | 470                             | 0.10            | 0.110                        | 0.80                          | L3                          | -   | 99913E3                                       |

Notes

- (1) Standard reflow soldering profile, see Fig. 4 and Table 4
- (2) Advanced reflow soldering profile, according to JEDEC J-STD-020, see Fig. 5 and Table 5
- (3) Determines the applicable row in the table "Endurance Test Duration and Useful Life"

Table 7

| ADDITIONAL ELECTRICAL DATA                   |  |  |
|--|--|--|
| PARAMETER                                    | CONDITIONS   | VALUE                                    |
| <b>Voltage</b>                               |  |  |
| Surge voltage for short periods              | IEC 60384-18, subclause 4.14   | $U_s \leq 1.1 \times U_R$                |
| Reverse voltage for short periods            | IEC 60384-18, subclause 4.16   | $U_{rev} \leq 1 V$                       |
| <b>Current</b>                               |  |  |
| Leakage current                              | After 2 min at U <sub>R</sub>  | $I_{L2} \leq 0.01 \times C_R \times U_R$ |
| <b>Inductance</b>                            |  |  |
| Equivalent series inductance (ESL)           | Ø D = 8 mm   | Typ. 6 nH                                |
|  | Ø D = 10 mm  | Typ. 8 nH                                |
|  | Ø D ≥ 12.5 mm  | Typ. 11 nH                               |
| <b>Resistance</b>                            |  |  |
| Equivalent series resistance (ESR) at 100 Hz | Calculated from tan δ <sub>max.</sub> and C <sub>R</sub> (see Table 6) | $ESR = \tan \delta / 2\pi f C_R$         |



CAPACITANCE

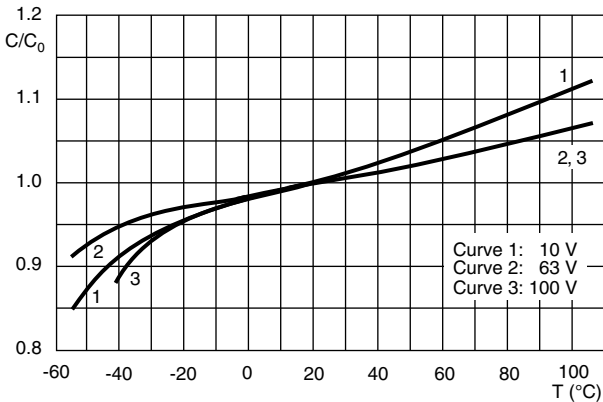

$C_0$  = Capacitance at 20 °C, 100 Hz

Fig. 6 - Typical multiplier of capacitance as a function of temperature at 100 Hz

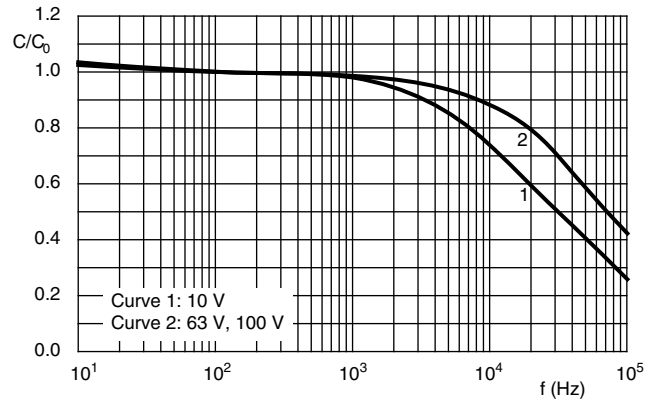

$C_0$  = Typical capacitance at 20 °C, 100 Hz

Fig. 7 - Typical multiplier of capacitance as a function of frequency at 20 °C

EQUIVALENT SERIES RESISTANCE (ESR)

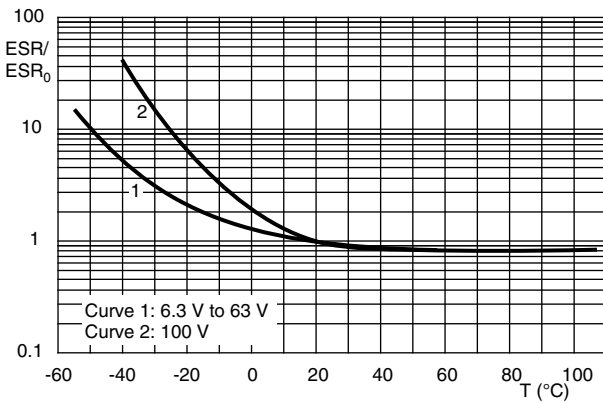

$ESR_0$  = Typical ESR at 20 °C, 100 Hz

Fig. 8 - Typical multiplier of ESR as a function of temperature at 100 Hz

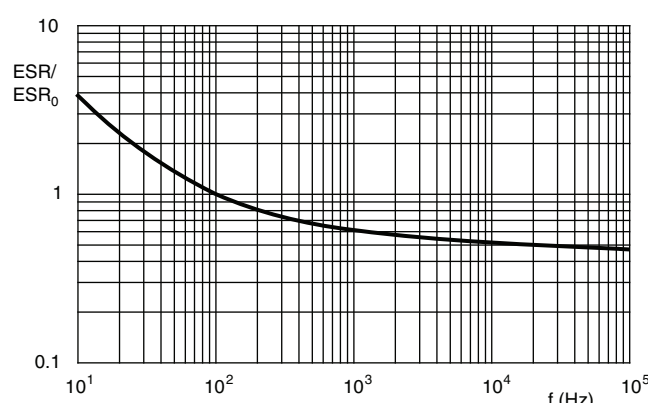

$ESR_0$  = Typical ESR at 20 °C, 100 Hz

Fig. 9 - Typical multiplier ESR as a function of frequency at 20 °C

DISSIPATION FACTOR (tan δ)

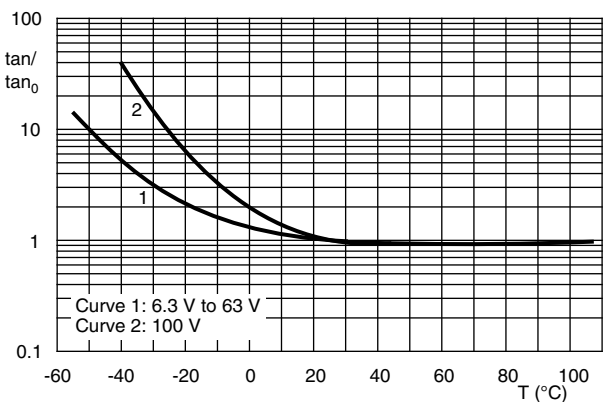

$\tan \delta_0$  = Typical  $\tan \delta$  at 20 °C, 100 Hz

Fig. 10 - Typical multiplier of dissipation factor  $\tan \delta$  as a function of temperature at 20 °C at 100 Hz

IMPEDANCE (Z)

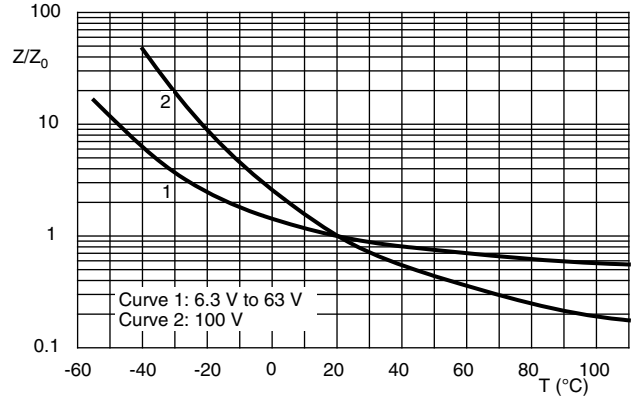

$Z_0$  = Typical impedance  $Z$  at 20 °C, 100 kHz

Fig. 11 - Typical multiplier of impedance  $Z$  as a function of temperature at 100 kHz

**IMPEDANCE (Z)**

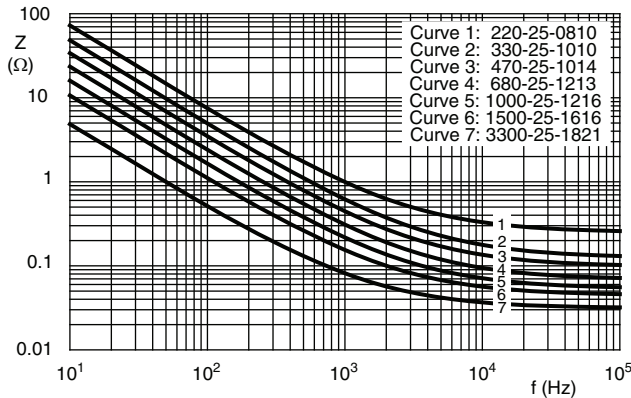

Fig. 12 - Typical impedance Z as a function of frequency at 20 °C

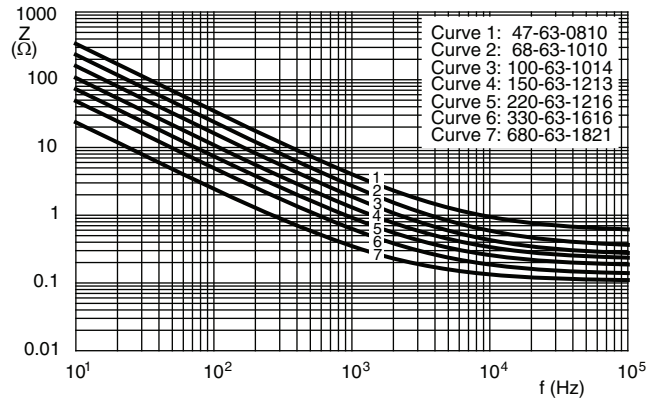

Fig. 13 - Typical impedance Z as a function of frequency at 20 °C

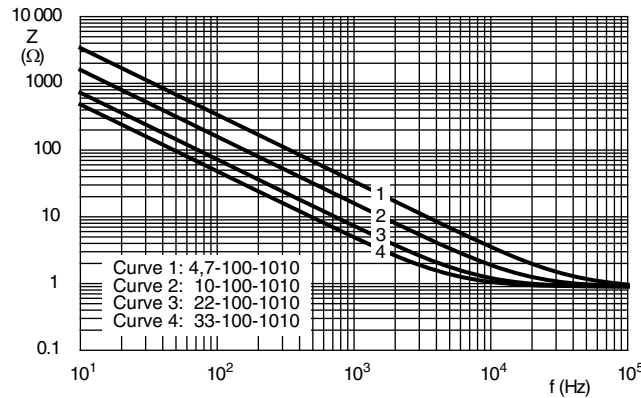

Fig. 14 - Typical impedance Z as a function of frequency at 20 °C

**RIPPLE CURRENT AND USEFUL LIFE**

Table 8

| ENDURANCE TEST DURATION AND USEFUL LIFE |                         |                           |   |
|---|-------------------------|---------------------------|---|
| LIFE CODE                               | ENDURANCE AT 105 °C (h) | USEFUL LIFE AT 105 °C (h) | USEFUL LIFE AT 40 °C 1.8 x I <sub>R</sub> APPLIED (h) |
| L1                                      | 2000                    | 2500                      | 125 000   |
| L2                                      | 2000                    | 3000                      | 150 000   |
| L3                                      | 3000                    | 5000                      | 250 000   |
| L4                                      | 5000                    | 6000                      | 300 000   |
| L5                                      | 6500                    | 7500                      | 375 000   |
| L6                                      | 8000                    | 10 000                    | 500 000   |

**Note**

- Multiplier of useful life code: CCC206

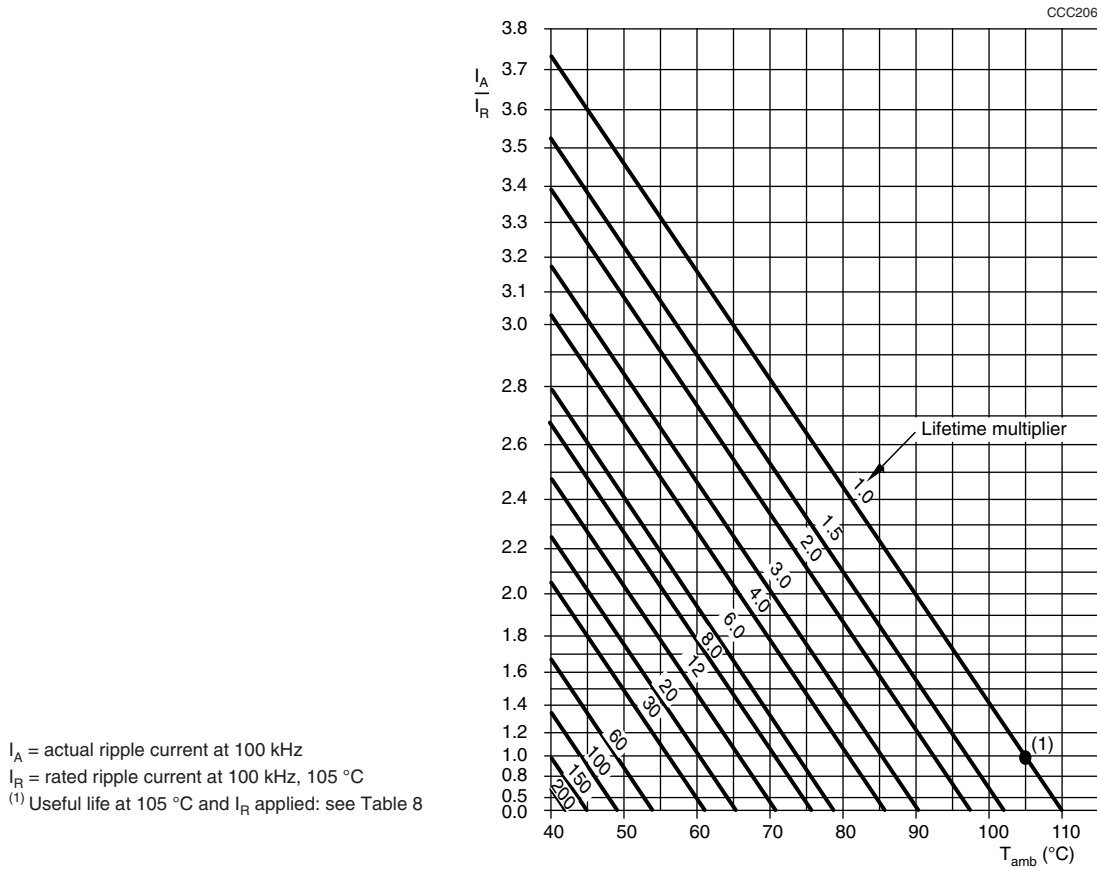

Fig. 15 - Multiplier of useful life as a function of ambient temperature and ripple current load

Table 9

| MULTIPLIER OF RIPPLE CURRENT ( $I_R$ ) AS A FUNCTION OF FREQUENCY |                  |      |      |      |        |        |         |
|---|------------------|------|------|------|--------|--------|---------|
| $V_R$<br>(V)  | FREQUENCY (Hz)   |      |      |      |        |        |         |
|   | 100              | 300  | 1000 | 3000 | 10 000 | 30 000 | 100 000 |
|   | $I_R$ MULTIPLIER |      |      |      |        |        |         |
| 6.3   | 0.70             | 0.80 | 0.85 | 0.93 | 0.95   | 0.97   | 1.00    |
| 10  | 0.70             | 0.80 | 0.85 | 0.93 | 0.95   | 0.97   | 1.00    |
| 16  | 0.70             | 0.80 | 0.85 | 0.93 | 0.95   | 0.97   | 1.00    |
| 25  | 0.70             | 0.80 | 0.85 | 0.93 | 0.95   | 0.97   | 1.00    |
| 35  | 0.65             | 0.80 | 0.85 | 0.93 | 0.95   | 0.97   | 1.00    |
| 50  | 0.60             | 0.75 | 0.85 | 0.93 | 0.95   | 0.97   | 1.00    |
| 63  | 0.60             | 0.75 | 0.85 | 0.93 | 0.95   | 0.97   | 1.00    |
| 80  | 0.60             | 0.75 | 0.85 | 0.93 | 0.95   | 0.97   | 1.00    |
| 100   | 0.60             | 0.75 | 0.85 | 0.93 | 0.95   | 0.97   | 1.00    |



Table 10

| TEST PROCEDURES AND REQUIREMENTS               |  |   |  |
|--|--|---|--|
| TEST   |  | PROCEDURE<br>(quick reference)  | REQUIREMENTS   |
| NAME OF TEST                                   | REFERENCE                                      |   |  |
| Mounting                                       | IEC 60384-18,<br>subclause 4.3                 | Shall be performed prior to tests mentioned below;<br>reflow soldering;<br>for maximum temperature load<br>refer to chapter "Mounting"                          | $\Delta C/C: \pm 5 \%$<br>$\tan \delta \leq \text{spec. limit}$<br>$I_{L2} \leq \text{spec. limit}$  |
| Endurance                                      | IEC 60384-18 / CECC32300,<br>subclause 4.15    | $T_{\text{amb}} = 105 \text{ }^\circ\text{C}$ ; $U_R$ applied;<br>for test duration see Table 8   | $U_R = 6.3 \text{ V}$ ; $\Delta C/C: \pm 25 \%$<br>$U_R \geq 10 \text{ V}$ ; $\Delta C/C: \pm 20 \%$<br>$\tan \delta \leq 2 \times \text{spec. limit}$<br>$I_{L2} \leq \text{spec. limit}$ |
| Useful life                                    | CECC 30301,<br>subclause 1.8.1                 | $T_{\text{amb}} = 105 \text{ }^\circ\text{C}$ ; $U_R$ and $I_R$ applied;<br>for test duration see Table 8   | $\Delta C/C: \pm 30 \%$<br>$\tan \delta \leq 3 \times \text{spec. limit}$<br>$I_{L2} \leq \text{spec. limit}$<br>no short or open circuit<br>total failure percentage: $\leq 1 \%$         |
| Shelf life<br>(storage at high<br>temperature) | IEC 60384-18 /<br>CECC32300,<br>subclause 4.17 | $T_{\text{amb}} = 105 \text{ }^\circ\text{C}$ ; no voltage applied;<br>1000 h<br>after test: $U_R$ to be applied for 30 min,<br>24 h to 48 h before measurement | For requirements<br>see "Endurance test" above   |

Statements about product lifetime are based on calculations and internal testing. They should only be interpreted as estimations. Also due to external factors, the lifetime in the field application may deviate from the calculated lifetime. In general, nothing stated herein shall be construed as a guarantee of durability.



## **Disclaimer**

ALL PRODUCT, PRODUCT SPECIFICATIONS AND DATA ARE SUBJECT TO CHANGE WITHOUT NOTICE TO IMPROVE RELIABILITY, FUNCTION OR DESIGN OR OTHERWISE.

Vishay Intertechnology, Inc., its affiliates, agents, and employees, and all persons acting on its or their behalf (collectively, "Vishay"), disclaim any and all liability for any errors, inaccuracies or incompleteness contained in any datasheet or in any other disclosure relating to any product.

Vishay makes no warranty, representation or guarantee regarding the suitability of the products for any particular purpose or the continuing production of any product. To the maximum extent permitted by applicable law, Vishay disclaims (i) any and all liability arising out of the application or use of any product, (ii) any and all liability, including without limitation special, consequential or incidental damages, and (iii) any and all implied warranties, including warranties of fitness for particular purpose, non-infringement and merchantability.

Statements regarding the suitability of products for certain types of applications are based on Vishay's knowledge of typical requirements that are often placed on Vishay products in generic applications. Such statements are not binding statements about the suitability of products for a particular application. It is the customer's responsibility to validate that a particular product with the properties described in the product specification is suitable for use in a particular application. Parameters provided in datasheets and / or specifications may vary in different applications and performance may vary over time. All operating parameters, including typical parameters, must be validated for each customer application by the customer's technical experts. Product specifications do not expand or otherwise modify Vishay's terms and conditions of purchase, including but not limited to the warranty expressed therein.

Hyperlinks included in this datasheet may direct users to third-party websites. These links are provided as a convenience and for informational purposes only. Inclusion of these hyperlinks does not constitute an endorsement or an approval by Vishay of any of the products, services or opinions of the corporation, organization or individual associated with the third-party website. Vishay disclaims any and all liability and bears no responsibility for the accuracy, legality or content of the third-party website or for that of subsequent links.

Except as expressly indicated in writing, Vishay products are not designed for use in medical, life-saving, or life-sustaining applications or for any other application in which the failure of the Vishay product could result in personal injury or death. Customers using or selling Vishay products not expressly indicated for use in such applications do so at their own risk. Please contact authorized Vishay personnel to obtain written terms and conditions regarding products designed for such applications.

No license, express or implied, by estoppel or otherwise, to any intellectual property rights is granted by this document or by any conduct of Vishay. Product names and markings noted herein may be trademarks of their respective owners.

# Mouser Electronics

Authorized Distributor

Click to View Pricing, Inventory, Delivery & Lifecycle Information:

## Vishay:

|                                       |                                       |                                       |                                       |                                       |                                       |
|---------------------------------------|---------------------------------------|---------------------------------------|---------------------------------------|---------------------------------------|---------------------------------------|
| <a href="#"><u>MAL215098476</u></a>   | <a href="#"><u>MAL215097301E3</u></a> | <a href="#"><u>MAL215097411E3</u></a> | <a href="#"><u>MAL215097412E3</u></a> | <a href="#"><u>MAL215097401E3</u></a> | <a href="#"><u>MAL215097402E3</u></a> |
| <a href="#"><u>MAL215097511E3</u></a> | <a href="#"><u>MAL215097512E3</u></a> | <a href="#"><u>MAL215097501E3</u></a> | <a href="#"><u>MAL215097502E3</u></a> | <a href="#"><u>MAL215097611E3</u></a> | <a href="#"><u>MAL215097612E3</u></a> |
| <a href="#"><u>MAL215097601E3</u></a> | <a href="#"><u>MAL215097602E3</u></a> | <a href="#"><u>MAL215097011E3</u></a> | <a href="#"><u>MAL215097001E3</u></a> | <a href="#"><u>MAL215097002E3</u></a> | <a href="#"><u>MAL215097111E3</u></a> |
| <a href="#"><u>MAL215097101E3</u></a> | <a href="#"><u>MAL215097102E3</u></a> | <a href="#"><u>MAL215097812E3</u></a> | <a href="#"><u>MAL215097801E3</u></a> | <a href="#"><u>MAL215097811E3</u></a> | <a href="#"><u>MAL215097802E3</u></a> |
| <a href="#"><u>MAL215097803E3</u></a> | <a href="#"><u>MAL215097012E3</u></a> | <a href="#"><u>MAL215097013E3</u></a> | <a href="#"><u>MAL215097112E3</u></a> | <a href="#"><u>MAL215097413E</u></a>  | <a href="#"><u>MAL215097414E3</u></a> |
| <a href="#"><u>MAL215097613E3</u></a> | <a href="#"><u>MAL215097614E3</u></a> | <a href="#"><u>MAL215097821E3</u></a> | <a href="#"><u>MAL215097901E3</u></a> | <a href="#"><u>MAL215097902E3</u></a> | <a href="#"><u>MAL215097903E3</u></a> |
| <a href="#"><u>MAL215097904E3</u></a> | <a href="#"><u>MAL215098685E3</u></a> | <a href="#"><u>MAL215098475E3</u></a> | <a href="#"><u>MAL215098476E3</u></a> | <a href="#"><u>MAL215098686E3</u></a> | <a href="#"><u>MAL215099003E3</u></a> |
| <a href="#"><u>MAL215099103E3</u></a> | <a href="#"><u>MAL215099804E3</u></a> | <a href="#"><u>MAL215099905E3</u></a> | <a href="#"><u>MAL215099708E3</u></a> | <a href="#"><u>MAL215099902E3</u></a> | <a href="#"><u>MAL215099908E3</u></a> |
| <a href="#"><u>MAL215099904E3</u></a> | <a href="#"><u>MAL215099702E3</u></a> | <a href="#"><u>MAL215099913E3</u></a> | <a href="#"><u>MAL215099705E3</u></a> | <a href="#"><u>MAL215099912E3</u></a> | <a href="#"><u>MAL215099911E3</u></a> |
| <a href="#"><u>MAL215099706E3</u></a> | <a href="#"><u>MAL215097701E3</u></a> | <a href="#"><u>MAL215099909E3</u></a> | <a href="#"><u>MAL215099707E3</u></a> | <a href="#"><u>MAL215099703E3</u></a> | <a href="#"><u>MAL215099704E3</u></a> |
| <a href="#"><u>MAL215099903E3</u></a> | <a href="#"><u>MAL215099906E3</u></a> | <a href="#"><u>MAL215099907E3</u></a> | <a href="#"><u>MAL215099701E3</u></a> | <a href="#"><u>MAL215099001E3</u></a> | <a href="#"><u>MAL215099013E3</u></a> |
| <a href="#"><u>MAL215099112E3</u></a> | <a href="#"><u>MAL215099101E3</u></a> | <a href="#"><u>MAL215099802E3</u></a> | <a href="#"><u>MAL215099012E3</u></a> | <a href="#"><u>MAL215099801E3</u></a> | <a href="#"><u>MAL215099114E3</u></a> |
| <a href="#"><u>MAL215099301E3</u></a> | <a href="#"><u>MAL215099401E3</u></a> | <a href="#"><u>MAL215099515E3</u></a> | <a href="#"><u>MAL215099601E3</u></a> | <a href="#"><u>MAL215099613E3</u></a> | <a href="#"><u>MAL215099616E3</u></a> |
| <a href="#"><u>MAL215099014E3</u></a> | <a href="#"><u>MAL215099115E3</u></a> | <a href="#"><u>MAL215099116E3</u></a> | <a href="#"><u>MAL215099117E3</u></a> | <a href="#"><u>MAL215099815E3</u></a> | <a href="#"><u>MAL215099819E3</u></a> |