

Click [here](#) to ask about the production status of specific part numbers.

## MAX77812

## 20A User-Configurable Quad-Phase Buck Converter

### General Description

The MAX77812 is a quad-phase high-efficiency step-down (buck) converter capable of delivering up to 20A of maximum current. Programmable startup/shutdown sequence and user-selectable phase configurations make the MAX77812 ideal for powering the latest generations of processors. With high-efficiency and small solution size, the MAX77812 is optimized for space constrained single-cell battery powered applications.

The MAX77812 uses an adaptive on-time PWM control scheme and it has SKIP and low-power SKIP modes for improved light-load efficiency. A programmable current limit reduces the overall solution footprint by optimizing inductors size. Differential sensing provides high output voltage accuracy, while enhanced transient response (ETR) allows fast output voltage adjustments to load transients. Programmable soft-start/stop and ramp-up/down slew rate provides control over an inrush current as the regulator transitions between operating states.

A 3.4MHz high-speed I<sup>2</sup>C or 30MHz SPI interface with dedicated logic inputs provide full configurability and control for system power optimization.

The MAX77812 is available in 3.408mm x 3.368mm, 64-bump 0.4mm pitch wafer-level package (WLP).

### Benefits and Features

- 20A Maximum Output Current (5A per Phase)
- V<sub>IN</sub> Range: 2.5V to 5.5V
- V<sub>OUT</sub> Range: 0.250V to 1.525V with 5mV Steps
- ±0.5% Initial Output Accuracy with Differential Sensing
- 5 User-Selectable Phase Configurations
- 91% Peak Efficiency (V<sub>IN</sub> = 3.8V, V<sub>OUT</sub> = 1.1V)
- Auto (SKIP/PWM) and Forced PWM Modes
- Enhanced Load Transient Response
- Programmable Ramp-Up/Down Slew Rates
- Programmable Startup/Shutdown Sequence
- UVLO, Short-Circuit, and Thermal Protections
- 2 User-Programmable General-Purpose Inputs
- 3.4MHz High Speed I<sup>2</sup>C and 30MHz SPI Interface
- 3.408mm x 3.368mm, 64-Bump WLP Package

### Applications

- CPU/GPU, FPGAs, and DSPs Power Supply
- AR/VR Headsets and Game Consoles
- Li-ion Battery Powered Equipment
- Space Constrained Portable Electronics

*Ordering Information appears at end of data sheet.*

### Typical Application Circuit

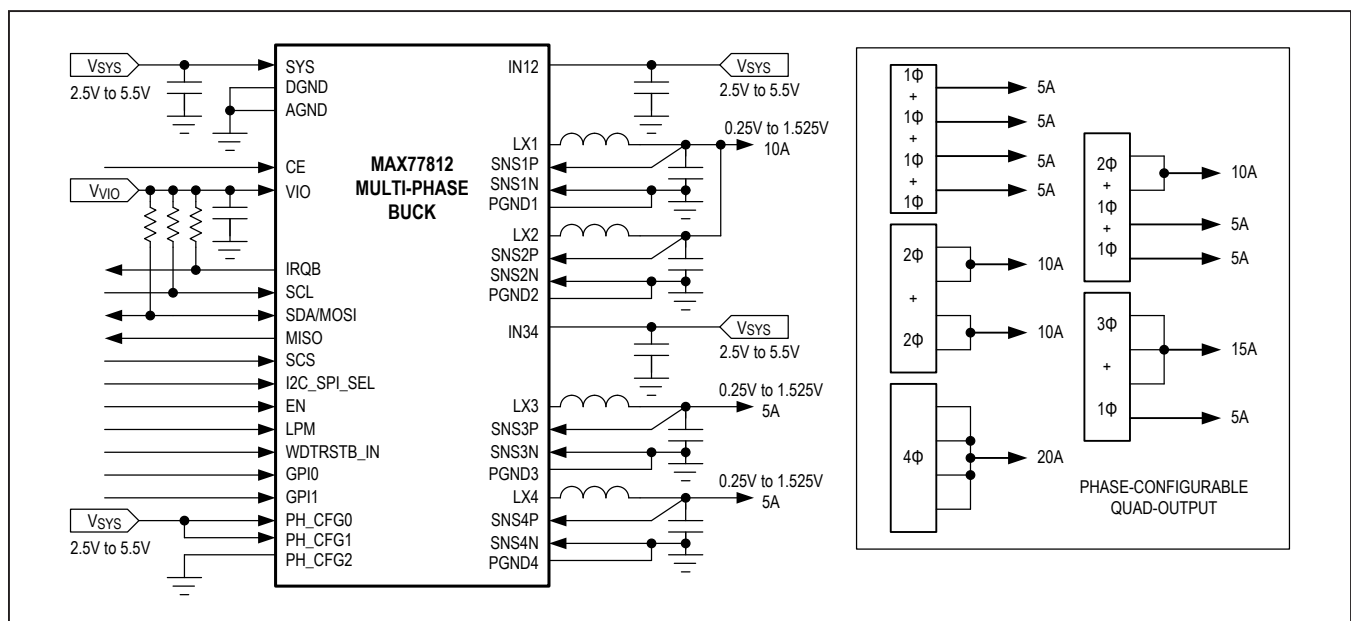

### Absolute Maximum Ratings

SYS, VIO to AGND.....	-0.3V to +6.0V	PGND1/2/3/4 to AGND.....	-0.3V to +0.3V
DGND to AGND.....	-0.3V to +0.3V	SNS1P, SNS2P, SNS3P, SNS4P to AGND ..	-0.3V to (V <sub>IN</sub> + 0.3V)
SCL, SDA/MOSI, MISO, SCS, IRQB, CE, EN, LPM, GPIO, GPI1, WDTRSTB_IN to DGND.....	-0.3V to (V <sub>VIO</sub> + 0.3V)	SNS1N, SNS2N, SNS3N, SNS4N to AGND.....	-0.3V to +0.3V
PH_CFG0, PH_CFG1, PH_CFG2, I2C_SPI_SEL to AGND .....	-0.3V to (V <sub>SYS</sub> + 0.3V)	Continuous Power Dissipation at T <sub>A</sub> = +70°C (derate 26.17mW/°C above +70°C) .....	2094mW
IN12, IN34 to PGNDx.....	-0.3V to (V <sub>SYS</sub> + 0.3V)	Junction Temperature.....	+150°C
LX1/2/3/4 to PGNDx.....	-0.3V to (V <sub>IN</sub> + 0.3V)	Storage Temperature Range .....	-65°C to +150°C
LX1/2/3/4 to PGNDx (Pulsed <10ns Voltage) .....	-3.0V to +7.0V	Soldering Temperature (reflow) .....	+260°C

**Note 1:** LXx node has internal clamp diodes to PGNDx and INx. Applications that give forward bias to these diodes should ensure that the total power loss does not exceed the power dissipation limit of IC package.

*Stresses beyond those listed under "Absolute Maximum Ratings" may cause permanent damage to the device. These are stress ratings only, and functional operation of the device at these or any other conditions beyond those indicated in the operational sections of the specifications is not implied. Exposure to absolute maximum rating conditions for extended periods may affect device reliability.*

### Recommended Operating Conditions

PARAMETER	SYMBOL	CONDITION	TYPICAL RANGE	UNITS
Input Voltage Range	V <sub>IN</sub>		2.5 to 5.5	V
Output Current Range	I <sub>OUT</sub>	For continuous operation at 5A (per phase), the junction temperature (T <sub>J</sub> ) is limited to +115°C. If the junction temperature is higher than +115°C, the expected lifetime at 5A continuous operation is reduced	0 to 5	A
Junction Temperature Range	T <sub>J</sub>		-40 to +125	°C

**Note:** These limits are not guaranteed.

### Package Thermal Characteristics (Note 2)

WLP

Junction-to-Ambient Thermal Resistance (θ<sub>JA</sub>) .....33.2°C/W

**Note 2:** Package thermal resistances were obtained using the method described in JEDEC specification JESD51-7, using a four-layer board. For detailed information on package thermal considerations, refer to [www.maximintegrated.com/thermal-tutorial](http://www.maximintegrated.com/thermal-tutorial).

### Electrical Characteristics

#### Top-Level Electrical Characteristics

(V<sub>SYS</sub> = V<sub>INx</sub> = +3.8V, V<sub>VIO</sub> = +1.8V, T<sub>A</sub> = T<sub>J</sub> = -40°C to +125°C, typical values are at T<sub>A</sub> = T<sub>J</sub> = +25°C)

PARAMETER	SYMBOL	CONDITIONS	MIN	TYP	MAX	UNITS
<b>GLOBAL INPUT SUPPLY</b>						
Operating Voltage Range	V <sub>SYS</sub>		2.5		5.5	V
Shutdown Supply Current	I <sub>SHDN</sub>	CE = low, T <sub>A</sub> = +25°C		2	5	µA
Standby Current	I <sub>STBY</sub>	CE = high and all outputs are off, T <sub>A</sub> = +25°C		25		µA

**Electrical Characteristics (continued)****Top-Level Electrical Characteristics (continued)**(V<sub>SYS</sub> = V<sub>INx</sub> = +3.8V, V<sub>VIO</sub> = +1.8V, T<sub>A</sub> = T<sub>J</sub> = -40°C to +125°C, typical values are at T<sub>A</sub> = T<sub>J</sub> = +25°C)

PARAMETER	SYMBOL	CONDITIONS	MIN	TYP	MAX	UNITS
No Load Supply Current in Low Power Skip Mode	I <sub>LP_SKIP1</sub>	4-phase configuration (no switching)		120		μA
	I <sub>LP_SKIP2</sub>	3 + 1-phase configuration (no switching)		190		
	I <sub>LP_SKIP3</sub>	2 + 2-phase configuration (no switching)		190		
	I <sub>LP_SKIP4</sub>	2 + 1 + 1-phase configuration (no switching)		265		
	I <sub>LP_SKIP5</sub>	1 + 1 + 1 + 1-phase configuration (no switching)		340	510	
No Load Supply Current in Skip Mode	I <sub>SKIP1</sub>	4-phase configuration (no switching)		150		μA
	I <sub>SKIP2</sub>	3 + 1-phase configuration (no switching)		250		
	I <sub>SKIP3</sub>	2 + 2-phase configuration (no switching)		250		
	I <sub>SKIP4</sub>	2 + 1 + 1-phase configuration (no switching)		350		
	I <sub>SKIP5</sub>	1 + 1 + 1 + 1-phase configuration (no switching)		460	690	
No Load Supply Current in Skip Mode with ETR	I <sub>SKIP_ETR1</sub>	4-phase configuration (no switching, ETR enabled)		180		μA
	I <sub>SKIP_ETR2</sub>	3 + 1-phase configuration (no switching, ETR enabled)		310		
	I <sub>SKIP_ETR3</sub>	2 + 2-phase configuration (no switching, ETR enabled)		310		
	I <sub>SKIP_ETR4</sub>	2 + 1 + 1-phase configuration (no switching, ETR enabled)		440		
	I <sub>SKIP_ETR5</sub>	1 + 1 + 1 + 1-phase configuration (no switching, ETR enabled)		580	870	
<b>V<sub>SYS</sub> UNDERVOLTAGE LOCKOUT</b>						
V <sub>SYS</sub> Undervoltage Lockout Threshold	V <sub>UVLO_R</sub>	V <sub>SYS</sub> rising	2.375	2.50	2.625	V
	V <sub>UVLO_F</sub>	V <sub>SYS</sub> falling (default)		2.15		
<b>THERMAL PROTECTION</b>						
Thermal Protection Threshold	T <sub>SHDN</sub>	T <sub>J</sub> rising, 15°C hysteresis		165		°C
Thermal Interrupt at 120°C	T <sub>INT120</sub>	T <sub>J</sub> rising, 15°C hysteresis		120		°C
Thermal Interrupt at 140°C	T <sub>INT140</sub>	T <sub>J</sub> rising, 15°C hysteresis		140		°C

**Electrical Characteristics (continued)****Top-Level Electrical Characteristics (continued)**(V<sub>SYS</sub> = V<sub>INx</sub> = +3.8V, V<sub>VIO</sub> = +1.8V, T<sub>A</sub> = T<sub>J</sub> = -40°C to +125°C, typical values are at T<sub>A</sub> = T<sub>J</sub> = +25°C)

PARAMETER	SYMBOL	CONDITIONS	MIN	TYP	MAX	UNITS
<b>LOGIC AND CONTROL INPUTS</b>						
Input Low Level	V <sub>IL</sub>	PH_CFG0, PH_CFG1, PH_CFG2, I2C_SPI_SEL, V <sub>SYS</sub> ≤ 5.5V, T <sub>A</sub> = +25°C			0.4	V
		CE, EN, LPM, GPIO, GPI1, WDTRSTB_IN, T <sub>A</sub> = +25°C			0.3 x V <sub>VIO</sub>	
Input High Level	V <sub>IH</sub>	PH_CFG0, PH_CFG1, PH_CFG2, I2C_SPI_SEL, V <sub>SYS</sub> ≤ 5.5V, T <sub>A</sub> = +25°C	1.2			V
		CE, EN, LPM, GPIO, GPI1, WDTRSTB_IN, T <sub>A</sub> = +25°C	0.7 x V <sub>VIO</sub>			
Logic Input Leakage Current	I <sub>LK</sub>	PH_CFG0, PH_CFG1, PH_CFG2, I2C_SPI_SEL, V <sub>SYS</sub> = 5.5V, CE = 1.8V, T <sub>A</sub> = +25°C	-1	+0.001	+1	μA
		CE, EN, LPM, GPIO, GPI1, CE = 1.8V, T <sub>A</sub> = +25°C	-1	+0.001	+1	
		PH_CFG0, PH_CFG1, PH_CFG2, I2C_SPI_SEL, V <sub>SYS</sub> = 5.5V, CE = 1.8V, T <sub>A</sub> = +85°C (Note 4)		0.1		
		CE, EN, LPM, GPIO, GPI1, CE = 1.8V, T <sub>A</sub> = +85°C (Note 4)		0.1		
$\overline{\text{IRQ}}$ Output Low Voltage	V <sub>OL</sub>	I <sub>SINK</sub> = 1mA			0.4	V
$\overline{\text{IRQ}}$ Output High Leakage	I <sub>LK_OH</sub>	T <sub>A</sub> = +25°C	-1	0.001	+1	μA
		T <sub>A</sub> = +85°C (Note 4)		0.1		
<b>INTERNAL PULL-UP/DOWN RESISTANCE</b>						
WDTRSTB_IN Pullup Resistance	R <sub>PU</sub>	Pullup resistance to VIO	400	800	1600	kΩ
GPIO, GPI1, EN, LPM Pulldown Resistance	R <sub>PD</sub>	Pulldown resistance to DGND	400	800	1600	kΩ

**Electrical Characteristics (continued)****Quad-Phase Buck Electrical Characteristics**(V<sub>SYS</sub> = V<sub>INx</sub> = +3.8V, V<sub>OUTx</sub> = 0.85V, T<sub>A</sub> = T<sub>J</sub> = -40°C to +125°C, typical values are at T<sub>A</sub> = T<sub>J</sub> = +25°C)

PARAMETER	SYMBOL	CONDITIONS	MIN	TYP	MAX	UNITS
<b>POWER SUPPLY</b>						
Input Voltage Range	V <sub>INx</sub>		2.5		V <sub>SYS</sub>	V
Output Voltage Range	V <sub>OUT</sub>	Programmable with 8-bit resolution, 5mV/LSB	0.25		1.525	V
<b>DC OUTPUT VOLTAGE ACCURACY</b>						
Output Voltage Accuracy	V <sub>ACC_INIT</sub>	Force PWM mode, differential remote sensing, V <sub>OUT</sub> ≥ 0.65V, I <sub>OUT</sub> = 0mA, C <sub>OUT(EFF)</sub> = 64μF, T <sub>A</sub> = +25°C	-0.5		+0.5	%
		Force PWM mode, differential remote sensing, 0.45V ≤ V <sub>OUT</sub> < 0.6V, I <sub>OUT</sub> = 0mA, C <sub>OUT(EFF)</sub> = 64μF, T <sub>A</sub> = +25°C	-6		+6	mV
Load Regulation		Forced PWM mode, differential remote sensing, I <sub>OUT</sub> = 0A to 5A, C <sub>OUT(EFF)</sub> = 64μF (Note 5)		-0.001		V/A
Line Regulation		Forced PWM mode, differential remote sensing, V <sub>INx</sub> = 2.5V to 5.5V, V <sub>OUT</sub> = Default, I <sub>OUT</sub> = 0mA, C <sub>OUT(EFF)</sub> = 64μF	-0.005		+0.005	V/V
<b>AC OUTPUT VOLTAGE ACCURACY</b>						
Line Transient Response	V <sub>DROOP</sub>	V <sub>INx</sub> = 3.4V to 2.9V to 3.4V, t <sub>RISE</sub> = t <sub>FALL</sub> = 10μs, V <sub>OUT</sub> = 1.1V, I <sub>OUT</sub> = 2A, L = 220nH (DCR = 9mΩ), C <sub>OUT(EFF)</sub> = 16μF (ESR = 5mΩ, ESL = 300pH) per phase (Note 5)		15		mV
Load Transient Response	V <sub>DROOP</sub>	SKIP/PWM mode, differential remote sensing, V <sub>OUT</sub> = 1.1V, I <sub>OUT</sub> = 0.1A to 4A (100A/μs), L = 220nH (DCR = 9mΩ), C <sub>OUT(EFF)</sub> = 16μF (ESR = 5mΩ, ESL = 300pH) per Phase (Note 5)		45		mV

**Electrical Characteristics (continued)****Quad-Phase Buck Electrical Characteristics (continued)**(V<sub>SYS</sub> = V<sub>INx</sub> = +3.8V, V<sub>OUTx</sub> = 0.85V, T<sub>A</sub> = T<sub>J</sub> = -40°C to +125°C, typical values are at T<sub>A</sub> = T<sub>J</sub> = +25°C)

PARAMETER	SYMBOL	CONDITIONS	MIN	TYP	MAX	UNITS
<b>RAMP RATE</b>						
Soft-Start Slew Rate		B_SS_SR[2:0] = 000b (Note 6)		1.25		mV/μs
		B_SS_SR[2:0] = 001b (Note 6)		2.5		
		B_SS_SR[2:0] = 010b (Note 6)		5		
		B_SS_SR[2:0] = 011b (Note 6)		10		
		B_SS_SR[2:0] = 100b (default) (Note 6)		20		
		B_SS_SR[2:0] = 101b (Note 6)		40		
		B_SS_SR[2:0] = 110b or 111b (Note 6)		60		
Shutdown Slew Rate		B_SD_SR[2:0] = 000b (Note 6)		1.25		mV/μs
		B_SD_SR[2:0] = 001b (Note 6)		2.5		
		B_SD_SR[2:0] = 010b (default) (Note 6)		5		
		B_SD_SR[2:0] = 011b (Note 6)		10		
		B_SD_SR[2:0] = 100b (Note 6)		20		
		B_SD_SR[2:0] = 101b (Note 6)		40		
		B_SD_SR[2:0] = 110b or 111b (Note 6)		60		

**Electrical Characteristics (continued)**

**Quad-Phase Buck Electrical Characteristics (continued)**

(V<sub>sys</sub> = V<sub>INx</sub> = +3.8V, V<sub>OUTx</sub> = 0.85V, T<sub>A</sub> = T<sub>J</sub> = -40°C to +125°C, typical values are at T<sub>A</sub> = T<sub>J</sub> = +25°C)

PARAMETER	SYMBOL	CONDITIONS	MIN	TYP	MAX	UNITS
DVS Ramp-Up Slew Rate		B_RU_SR[2:0] = 000b (Note 6)		1.25		mV/μs
		B_RU_SR[2:0] = 001b (Note 6)		2.5		
		B_RU_SR[2:0] = 010b (Note 6)		5		
		B_RU_SR[2:0] = 011b (Note 6)		10		
		B_RU_SR[2:0] = 100b (default) (Note 6)		20		
		B_RU_SR[2:0] = 101b (Note 6)		40		
		B_RU_SR[2:0] = 110b or 111b (Note 6)		60		
DVS Ramp-Down Slew Rate		B_RD_SR[2:0] = 000b (Note 6)		1.25		mV/μs
		B_RD_SR[2:0] = 001b (Note 6)		2.5		
		B_RD_SR[2:0] = 010b (default) (Note 6)		5		
		B_RD_SR[2:0] = 011b (Note 6)		10		
		B_RD_SR[2:0] = 100b (Note 6)		20		
		B_RD_SR[2:0] = 101b (Note 6)		40		
		B_RD_SR[2:0] = 110b or 111b (Note 6)		60		
Turn-On Delay Time	t <sub>ON_DLY1</sub>	From EN signal to LXB switching with bias on (Note 6)		30		μs
	t <sub>ON_DLY2</sub>	From EN signal to LXB switching with bias off (Note 5)		85		

**Electrical Characteristics (continued)****Quad-Phase Buck Electrical Characteristics (continued)**(V<sub>SYS</sub> = V<sub>INx</sub> = +3.8V, V<sub>OUTx</sub> = 0.85V, T<sub>A</sub> = T<sub>J</sub> = -40°C to +125°C, typical values are at T<sub>A</sub> = T<sub>J</sub> = +25°C)

PARAMETER	SYMBOL	CONDITIONS	MIN	TYP	MAX	UNITS
<b>POWER STAGE</b>						
Maximum Output Current	I <sub>OUT(MAX)</sub>	RMS current per phase, V <sub>IN</sub> < 3.2V (Note 5)		4000		mA
	I <sub>OUT(MAX)</sub>	RMS current per phase, 3.2V ≤ V <sub>IN</sub> ≤ 5.5V (Note 5)		5000		
PMOS Peak Current Limit	I <sub>PLIM</sub>	Mx_ILIM[2:0] = 000b		3000		mA
	I <sub>PLIM</sub>	Mx_ILIM[2:0] = 001b		3600		
	I <sub>PLIM</sub>	Mx_ILIM[2:0] = 010b		4200		
	I <sub>PLIM</sub>	Mx_ILIM[2:0] = 011b		4800		
	I <sub>PLIM</sub>	Mx_ILIM[2:0] = 100b		5400		
	I <sub>PLIM</sub>	Mx_ILIM[2:0] = 101b (default)	4800	6000	7200	
	I <sub>PLIM</sub>	Mx_ILIM[2:0] = 110b		6600		
NMOS Valley Current Limit	I <sub>VLIM</sub>	Mx_ILIM[2:0] = 000b		2000		mA
	I <sub>VLIM</sub>	Mx_ILIM[2:0] = 001b		2400		
	I <sub>VLIM</sub>	Mx_ILIM[2:0] = 010b		2800		
	I <sub>VLIM</sub>	Mx_ILIM[2:0] = 011b		3200		
	I <sub>VLIM</sub>	Mx_ILIM[2:0] = 100b		3600		
	I <sub>VLIM</sub>	Mx_ILIM[2:0] = 101b (default)	3200	4000	4800	
	I <sub>VLIM</sub>	Mx_ILIM[2:0] = 110b		4400		
NMOS Negative Current Limit	I <sub>NLIM</sub>	Per phase	-2000	-1500	-1000	mA
Switching Frequency	f <sub>SW</sub>	V <sub>OUT</sub> = default, Forced PWM mode	1.6	2.0	2.8	MHz
High-Side PMOS On-Resistance	R <sub>DSON(PMOS)</sub>	INx to LXx, I <sub>LXx</sub> = -150mA		32	70	mΩ
Low-Side NMOS On-Resistance	R <sub>DSON(NMOS)</sub>	LXx to PGNDx, I <sub>LXx</sub> = 150mA		15	29	mΩ
LX Active Discharge Resistance	R <sub>AD_LX</sub>	Resistance from LXx to PGNDx, per phase, output disabled		100	200	Ω



**Electrical Characteristics (continued)****Quad-Phase Buck Electrical Characteristics (continued)**(V<sub>SYS</sub> = V<sub>INx</sub> = +3.8V, V<sub>OUTx</sub> = 0.85V, T<sub>A</sub> = T<sub>J</sub> = -40°C to +125°C, typical values are at T<sub>A</sub> = T<sub>J</sub> = +25°C)

PARAMETER	SYMBOL	CONDITIONS	MIN	TYP	MAX	UNITS
LX Leakage Current	I <sub>LKG_LX</sub>	V <sub>LXx</sub> = 0V or 5.5V, T <sub>A</sub> = +25°C	-1	0.1	+1	μA
	I <sub>LKG_LX</sub>	V <sub>LXx</sub> = 0V or 5.5V, T <sub>A</sub> = +85°C (Note 4)		1		
Nominal Inductance	L <sub>NOM</sub>	(Note 5)		220		nH
Minimum Effective Output Capacitance	C <sub>OUT(EFF_MIN)</sub>	0μA < I <sub>OUT</sub> < 5000mA per phase (Note 5)		16		μF
<b>EFFICIENCY AND OUTPUT RIPPLE</b>						
Peak Efficiency	η <sub>PK</sub>	L = 220nH (DCR = 9mΩ), C <sub>OUT(EFF)</sub> = 16μF (ESR = 5mΩ, ESL = 300pH) per Phase (Note 5)		90		%
Heavy Load Efficiency	η <sub>HEAVY</sub>	I <sub>OUT</sub> = 5A, L = 220nH (DCR = 9mΩ), C <sub>OUT(EFF)</sub> = 16μF (ESR = 5mΩ, ESL = 300pH) per Phase (Note 5)		75		%
Skip Mode Output Ripple	V <sub>RIP_SKIP</sub>	Skip mode, I <sub>OUT</sub> = 0.1A, L = 220nH (DCR = 9mΩ), C <sub>OUT(EFF)</sub> = 16μF (ESR = 5mΩ, ESL = 300pH) per phase (Note 7)		10		mV <sub>P-P</sub>
FPWM Mode Output Ripple	V <sub>RIP_FPWM</sub>	Forced PWM mode, differential remote sensing, I <sub>OUT</sub> = 0.1A, L = 220nH (DCR = 9mΩ), C <sub>OUT(EFF)</sub> = 16μF (ESR = 5mΩ, ESL = 300pH) per phase (Note 7)		5		mV <sub>P-P</sub>
<b>POWER OK COMPARATOR</b>						
Output POK Trip Level		Rising threshold		90		%
		Falling threshold		85	90	

**Electrical Characteristics (continued)****I<sup>2</sup>C Electrical Characteristics**(V<sub>SYS</sub> = V<sub>INx</sub> = +3.8V, V<sub>VIO</sub> = +1.8V, T<sub>A</sub> = T<sub>J</sub> = -40°C to +125°C, typical values are at T<sub>A</sub> = T<sub>J</sub> = +25°C)

PARAMETER	SYMBOL	CONDITIONS	MIN	TYP	MAX	UNITS
<b>POWER SUPPLY</b>						
VIO Supply Voltage Range	V <sub>VIO</sub>		1.65	1.8	V <sub>SYS</sub>	V
VIO Dynamic Supply Current	I <sub>VIO</sub>	f <sub>SCL</sub> = f <sub>SDA</sub> = 1MHz		50		μA
V <sub>SYS</sub> Dynamic Supply Current	I <sub>SYS</sub>			5		μA
<b>SDA AND SCL I/O STAGES</b>						
SCL, SDA Input High Voltage	V <sub>IH</sub>		0.7 x V <sub>VIO</sub>			V
SCL, SDA Input Low Voltage	V <sub>IL</sub>				0.3 x V <sub>VIO</sub>	V
SCL, SDA Input Hysteresis	V <sub>HYS</sub>			0.05 x V <sub>VIO</sub>		V
SCL, SDA Input Hysteresis in HS Mode	V <sub>HYS_HS</sub>			0.1 x V <sub>VIO</sub>		V
SDA Output Low Voltage	V <sub>OL</sub>	I <sub>SINK</sub> = 5mA			0.4	V
SCL, SDA Input Capacitance	C <sub>I</sub>			10		pF
SCL, SDA Input Leakage Current	I <sub>LK</sub>	T <sub>A</sub> = +25°C	-1	+0.001	+1	μA
		T <sub>A</sub> = +85°C (Note 4)		0.1		
<b>I<sup>2</sup>C-COMPATIBLE INTERFACE TIMING (STANDARD, FAST AND FAST MODE PLUS) (Note 5)</b>						
Clock Frequency	f <sub>SCL</sub>		0		1000	kHz
Bus Free Time between STOP and START Condition	t <sub>BUSF</sub>		0.5			μs
Hold Time (REPEATED) START Condition	t <sub>HD_START</sub>		0.26			μs
SCL Low Period	t <sub>LOW</sub>		0.5			μs
SCL High Period	t <sub>HIGH</sub>		0.26			μs
Setup Time REPEATED START Condition	t <sub>SU_START</sub>		0.26			μs
Data Hold Time	t <sub>HD_DATA</sub>	Transmit mode	0		450	ns
Data Setup Time	t <sub>SU_DATA</sub>		50			ns
SCL, SDA Receiving Rise Time	t <sub>R_REV</sub>				120	ns
SCL, SDA Receiving Fall Time	t <sub>F_REV</sub>		20 x V <sub>VIO</sub> /5.5		120	ns

**Electrical Characteristics (continued)****I<sup>2</sup>C Electrical Characteristics (continued)**(V<sub>sys</sub> = V<sub>INx</sub> = +3.8V, V<sub>VIO</sub> = +1.8V, T<sub>A</sub> = T<sub>J</sub> = -40°C to +125°C, typical values are at T<sub>A</sub> = T<sub>J</sub> = +25°C)

PARAMETER	SYMBOL	CONDITIONS	MIN	TYP	MAX	UNITS
SCL, SDA Transmitting Fall Time	t <sub>F_TRA</sub>		20 x V <sub>VIO</sub> /5.5		120	ns
Setup Time for STOP Condition	t <sub>SU_STOP</sub>		0.26			μs
Data Valid Time	t <sub>VD_DATA</sub>				450	ns
Data Valid Acknowledge Time	t <sub>VD_ACK</sub>				450	ns
Bus Capacitance	C <sub>B</sub>				550	pF
Pulse Width of Suppressed Spikes	t <sub>SP</sub>				50	ns
<b>I<sup>2</sup>C-COMPATIBLE INTERFACE TIMING (HIGH-SPEED MODE, C<sub>B</sub> = 100pF) (Note 5)</b>						
Clock Frequency	f <sub>SCL</sub>				3.4	MHz
Hold Time (REPEATED) START Condition	t <sub>HD_START</sub>		160			ns
SCL LOW Period	t <sub>LOW</sub>		160			ns
SCL HIGH Period	t <sub>HIGH</sub>		60			ns
Setup Time REPEATED START Condition	t <sub>SU_START</sub>		160			ns
Data Hold Time	t <sub>HD_DATA</sub>		0		70	ns
Data Setup Time	t <sub>SU_DATA</sub>		10			ns
SCL Rise Time	t <sub>R_SCL</sub>	T <sub>A</sub> = +25°C	10		40	ns
SCL Rise Time after REPEATED START Condition and after Acknowledge Bit	t <sub>R_SCL1</sub>	T <sub>A</sub> = +25°C	10		40	ns
SCL Fall Time	t <sub>F_SCL</sub>	T <sub>A</sub> = +25°C	10		40	ns
SDA Rise Time	t <sub>R_SDA</sub>	T <sub>A</sub> = +25°C	10		40	ns
SDA Fall Time	t <sub>F_SDA</sub>	T <sub>A</sub> = +25°C			40	ns
Setup Time for STOP Condition	t <sub>SU_STOP</sub>		160			ns
Bus Capacitance	C <sub>B</sub>				100	pF
Pulse Width of Suppressed Spikes	t <sub>SP</sub>		0		10	ns

**Electrical Characteristics (continued)****I<sup>2</sup>C Electrical Characteristics (continued)**(V<sub>SYS</sub> = V<sub>INx</sub> = +3.8V, V<sub>VIO</sub> = +1.8V, T<sub>A</sub> = T<sub>J</sub> = -40°C to +125°C, typical values are at T<sub>A</sub> = T<sub>J</sub> = +25°C)

PARAMETER	SYMBOL	CONDITIONS	MIN	TYP	MAX	UNITS
<b>I<sup>2</sup>C-COMPATIBLE INTERFACE TIMING (HIGH-SPEED MODE, C<sub>B</sub> = 400pF) (Note 5)</b>						
Clock Frequency	f <sub>SCL</sub>				1.7	MHz
Hold Time (REPEATED) START Condition	t <sub>HD_START</sub>		160			ns
SCL Low Period	t <sub>LOW</sub>		320			ns
SCL High Period	t <sub>HIGH</sub>		120			ns
Setup Time REPEATED START Condition	t <sub>SU_START</sub>		160			ns
DATA Hold Time	t <sub>HD_DATA</sub>		0		150	ns
DATA Setup Time	t <sub>SU_DATA</sub>		10			ns
SCL Rise Time	t <sub>R_SCL</sub>	T <sub>A</sub> = +25°C	20		80	ns
SCL Rise Time after REPEATED START Condition and after Acknowledge Bit	t <sub>R_SCL1</sub>	T <sub>A</sub> = +25°C	20		80	ns
SCL Fall Time	t <sub>F_SCL</sub>	T <sub>A</sub> = +25°C	20		80	ns
SDA Rise Time	t <sub>R_SDA</sub>	T <sub>A</sub> = +25°C	20		80	ns
SDA Fall Time	t <sub>F_SDA</sub>	T <sub>A</sub> = +25°C			80	ns
Setup Time for STOP Condition	t <sub>SU_STOP</sub>		160			ns
Bus Capacitance	C <sub>B</sub>				400	pF
Pulse Width of Suppressed Spikes	t <sub>SP</sub>		0		10	ns

## Electrical Characteristics (continued)

## SPI Electrical Characteristics

(V<sub>SYS</sub> = V<sub>INx</sub> = +3.8V, V<sub>VIO</sub> = +1.8V, T<sub>A</sub> = T<sub>J</sub> = -40°C to +125°C, typical values are at T<sub>A</sub> = T<sub>J</sub> = +25°C)

PARAMETER	SYMBOL	CONDITIONS	MIN	TYP	MAX	UNITS
<b>POWER SUPPLY AND I/O STAGES</b>						
VIO Supply Voltage Range	V <sub>VIO</sub>		1.65	1.8	V <sub>SYS</sub>	V
Input Leakage Current (SCS, SCL, MOSI)	I <sub>IH_SPI</sub> , I <sub>IL_SPI</sub>	T <sub>A</sub> = +25°C	-1	+0.001	+1	μA
		T <sub>A</sub> = +85°C (Note 4)		0.1		
Input Capacitance (SCS, SCL, MOSI)	C <sub>I</sub>			10		pF
Input LOW Voltage (SCS, SCL, MOSI)	V <sub>IL</sub>				0.3 x V <sub>VIO</sub>	V
Input HIGH Voltage (SCS, SCL, MOSI)	V <sub>IH</sub>		0.7 x V <sub>VIO</sub>			V
Input Hysteresis (SCS, SCL, MOSI)	V <sub>HYS</sub>			0.1 x V <sub>VIO</sub>		
MISO Output Low Voltage	V <sub>OL</sub>	I <sub>OL</sub> = 1mA			0.2	V
MISO Output High Voltage	V <sub>OH</sub>	I <sub>OH</sub> = 1mA	V <sub>VIO</sub> - 0.2			V
MISO Leakage Current	I <sub>LK_HIZ</sub>	High-impedance state, T <sub>A</sub> = +25°C	-1	+0.001	+1	μA
		High-impedance state, T <sub>A</sub> = +85°C (Note 4)		0.1		
<b>SPI INTERFACE TIMING (Note 5)</b>						
SPI Operating Frequency	f <sub>SCL</sub>			26	30	MHz
MOSI Input Valid to SCL Rising Edge	t <sub>SU_MOSI</sub>		10			ns
MOSI Input Valid from SCL Rising Edge	t <sub>HD_MOSI</sub>		10			ns
MISO Valid from SCL Rising Edge	t <sub>D_MISO</sub>	C <sub>L</sub> = 50pF		9		ns
MISO Rising/Falling Time	t <sub>R</sub> , t <sub>F</sub>	C <sub>L</sub> = 20pF			10	ns
SCS Setup Time	t <sub>SU_SCS</sub>		20			ns
SCS Hold Time	t <sub>HD_SCS</sub>		20			ns
Minimum SCS High Pulse Width	t <sub>SCS_H(MIN)</sub>		50			ns

**Note 3:** Limits are 100% production tested at T<sub>A</sub> = +25°C. Limits over the operating temperature range are guaranteed through correlation using statistical quality control methods.

**Note 4:** Guaranteed by ATE characterization. Not directly tested in production.

**Note 5:** Guaranteed by design. Not production tested.

**Note 6:** Guaranteed by design. Production tested through scan.

**Note 7:** Internal design target.

Typical Operating Characteristics

( $V_{SYS} = 3.8V$ ,  $V_{OUT} = 0.85V$ ,  $I_{OUT} = 0A$ , CE = high, 4-Phase (1 Output), FPWM = 0, LPM = 0, ETR = 0, L = 220nH,  $C_{OUT} = (22\mu F + 0.1\mu F + 2 \times 4.3\mu F)$ ,  $T_A = +25^\circ C$ , unless otherwise noted.)

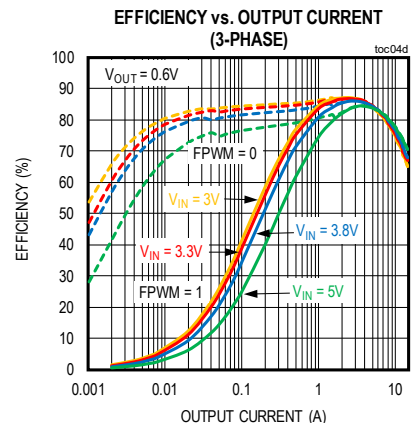
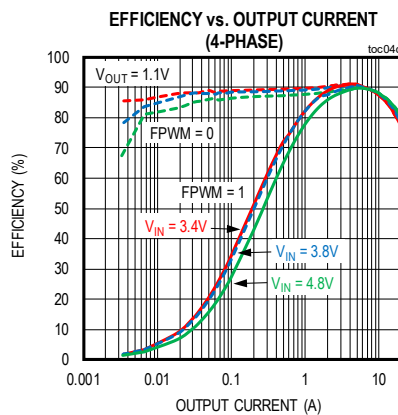
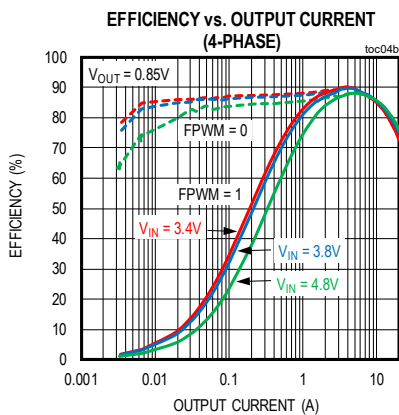
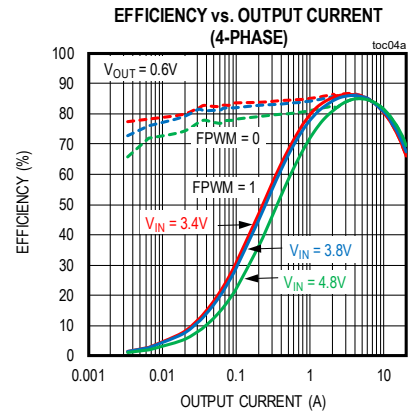
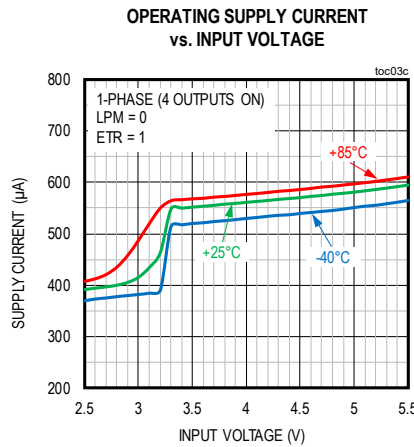
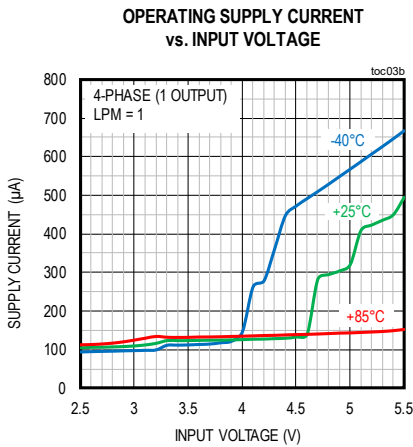
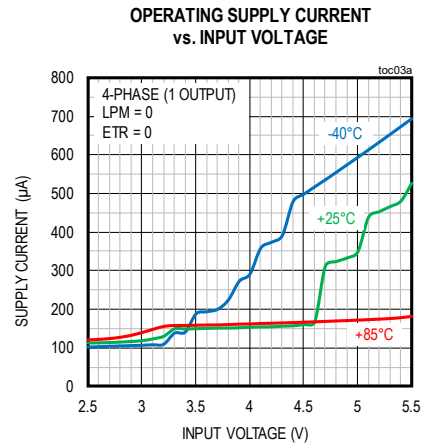
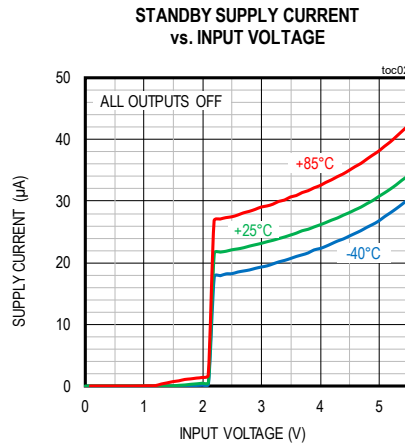
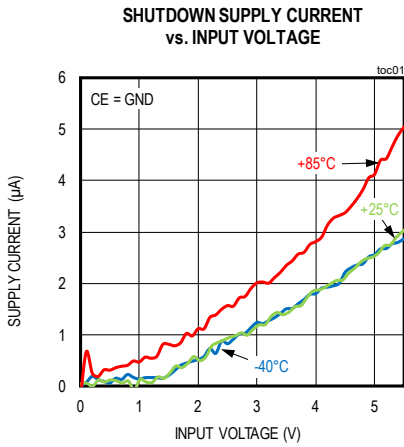

Typical Operating Characteristics (continued)

( $V_{SYS} = 3.8V$ ,  $V_{OUT} = 0.85V$ ,  $I_{OUT} = 0A$ , CE = high, 4-Phase (1 Output), FPWM = 0, LPM = 0, ETR = 0, L = 220nH,  $C_{OUT} = (22\mu F + 0.1\mu F + 2 \times 4.3\mu F)$ ,  $T_A = +25^\circ C$ , unless otherwise noted.)

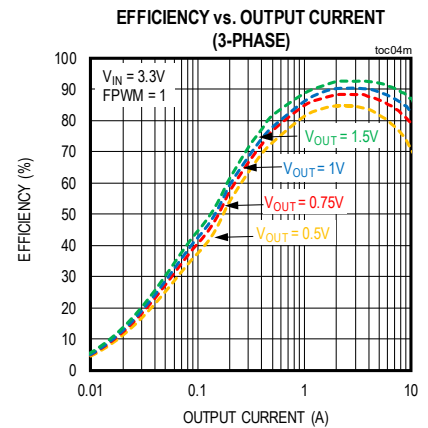
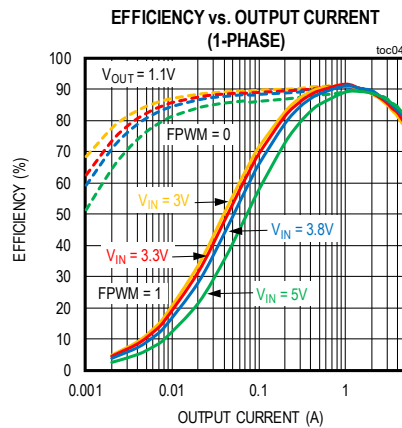
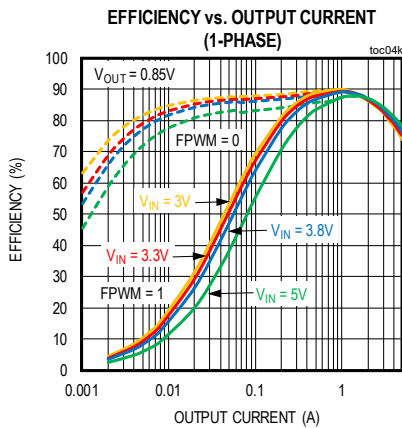
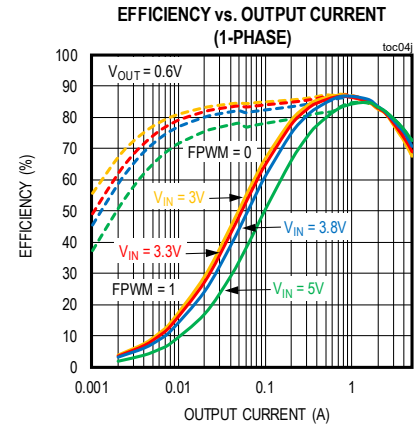
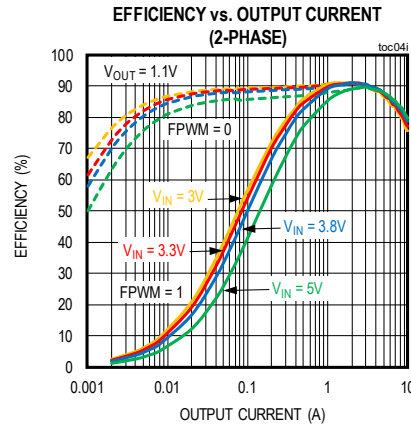
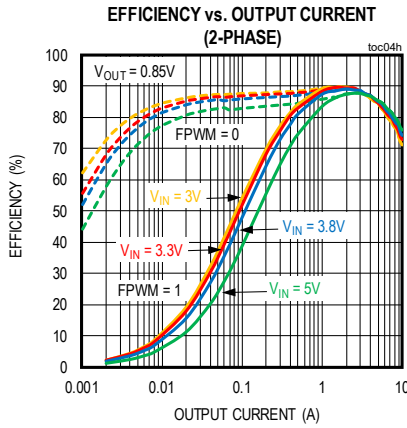
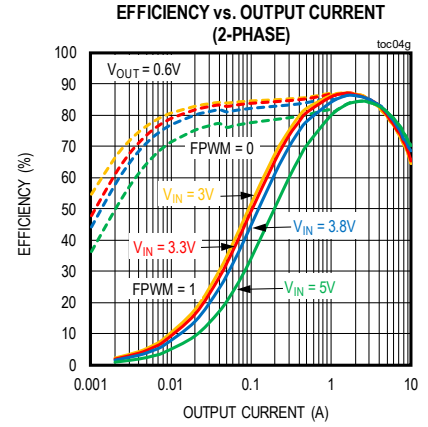
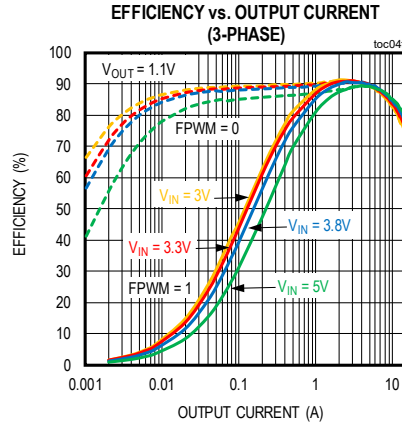
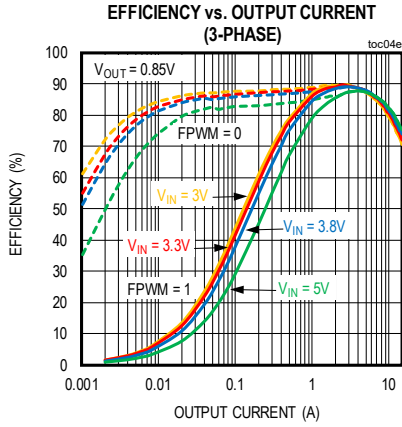

Typical Operating Characteristics (continued)

( $V_{SYS} = 3.8V$ ,  $V_{OUT} = 0.85V$ ,  $I_{OUT} = 0A$ , CE = high, 4-Phase (1 Output), FPWM = 0, LPM = 0, ETR = 0, L = 220nH,  $C_{OUT} = (22\mu F + 0.1\mu F + 2 \times 4.3\mu F)$ ,  $T_A = +25^\circ C$ , unless otherwise noted.)

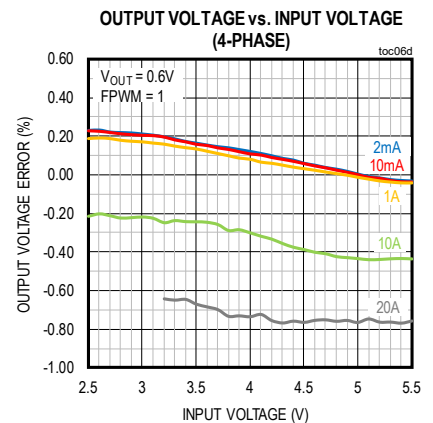
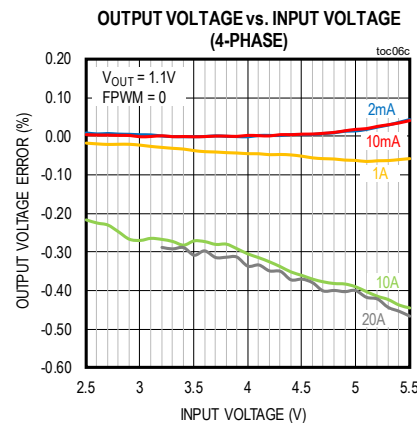
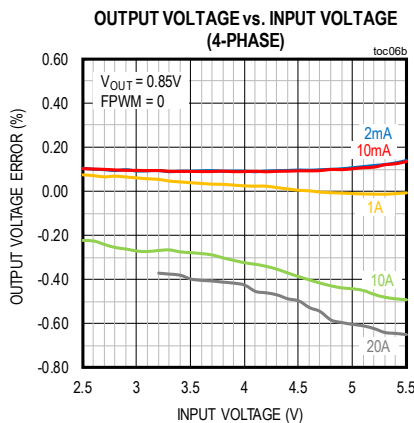
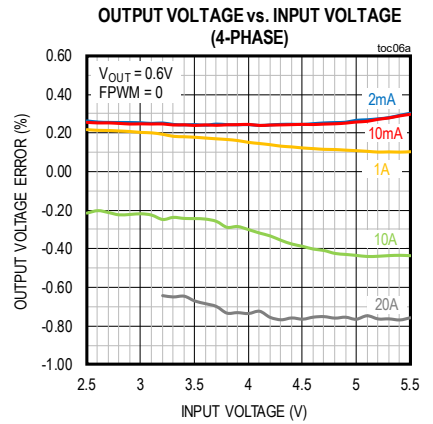
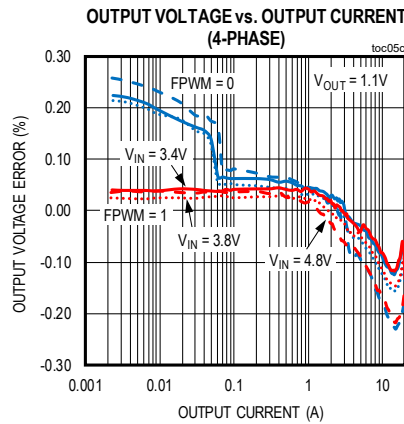
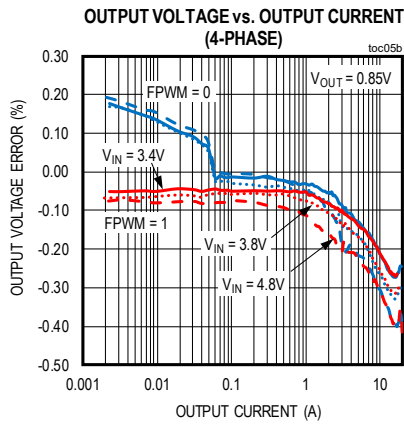
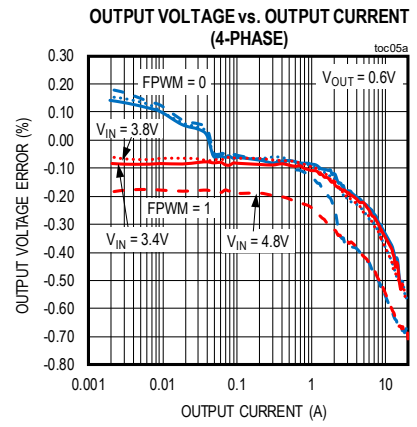
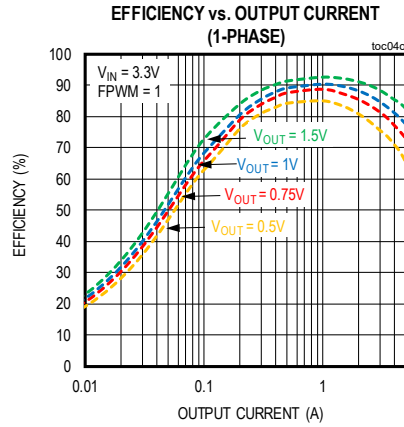
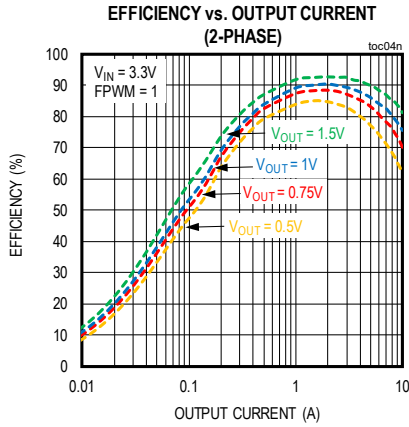



Typical Operating Characteristics (continued)

( $V_{SYS} = 3.8V$ ,  $V_{OUT} = 0.85V$ ,  $I_{OUT} = 0A$ , CE = high, 4-Phase (1 Output), FPWM = 0, LPM = 0, ETR = 0, L = 220nH,  $C_{OUT} = (22\mu F + 0.1\mu F + 2 \times 4.3\mu F)$ ,  $T_A = +25^\circ C$ , unless otherwise noted.)

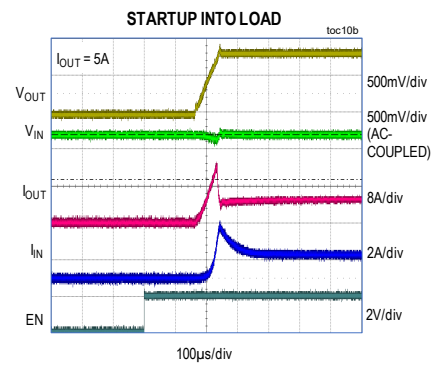
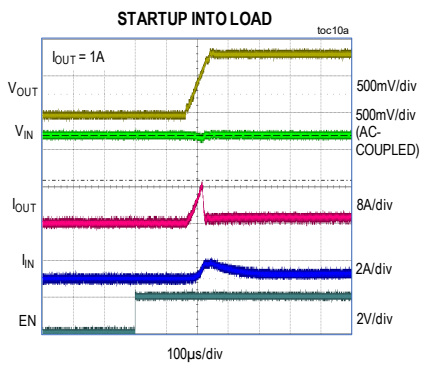
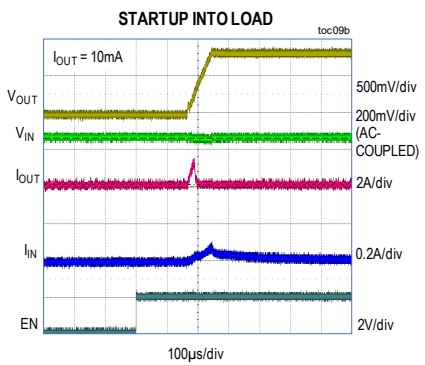
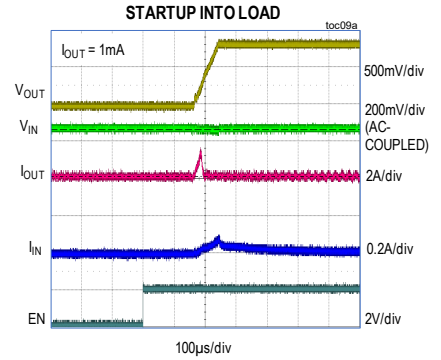
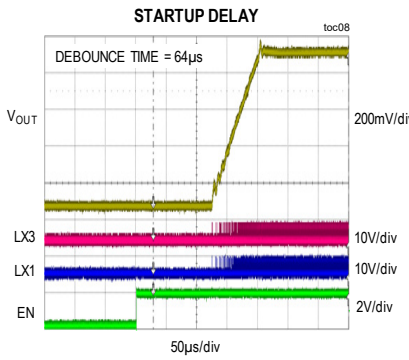
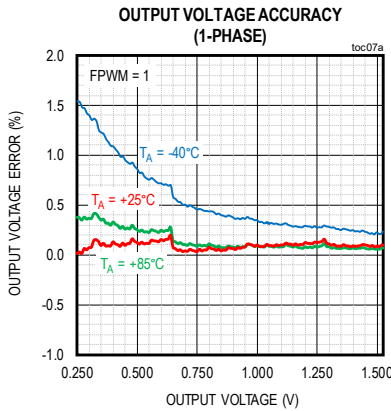
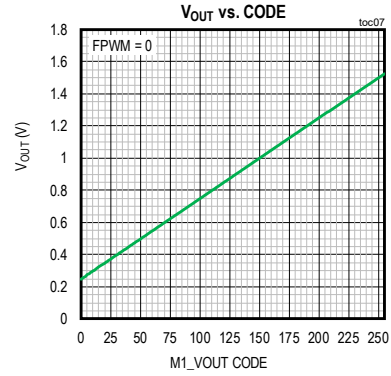
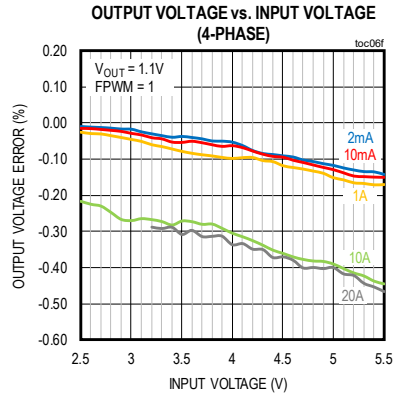
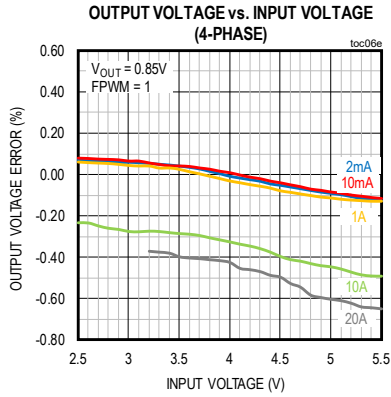

Typical Operating Characteristics (continued)

( $V_{SYS} = 3.8V$ ,  $V_{OUT} = 0.85V$ ,  $I_{OUT} = 0A$ , CE = high, 4-Phase (1 Output), FPWM = 0, LPM = 0, ETR = 0, L = 220nH,  $C_{OUT} = (22\mu F + 0.1\mu F + 2 \times 4.3\mu F)$ ,  $T_A = +25^\circ C$ , unless otherwise noted.)

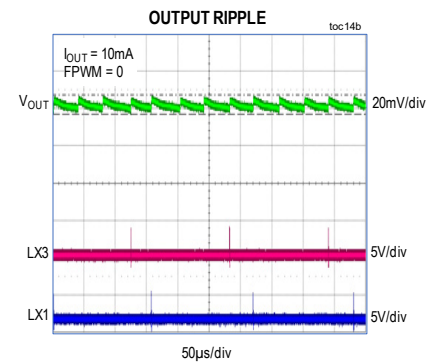
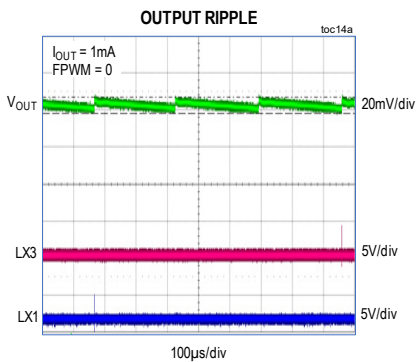
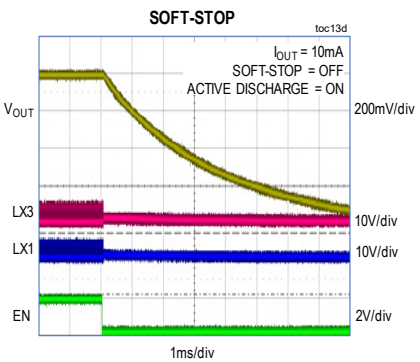
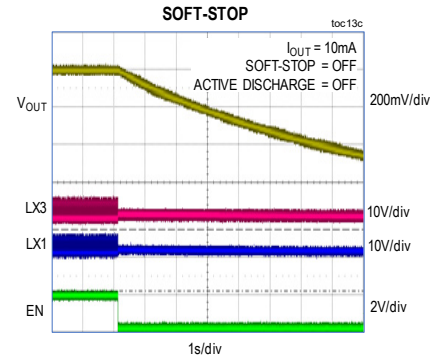
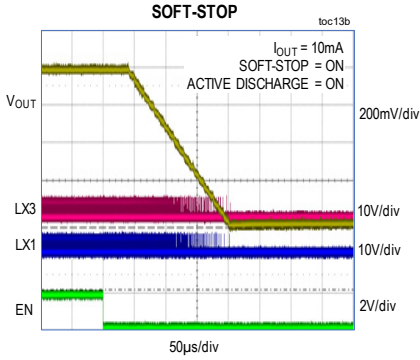
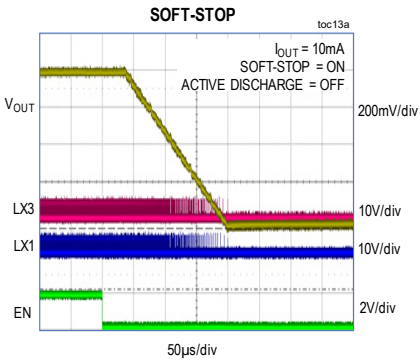
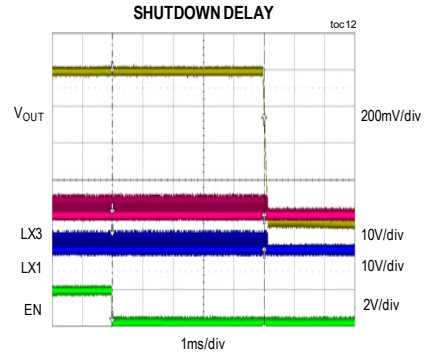
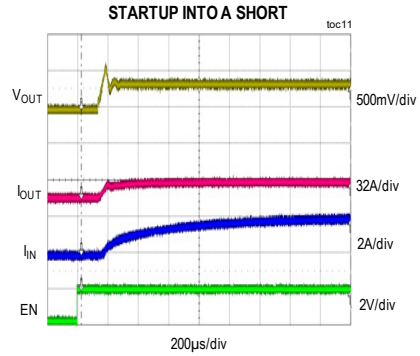
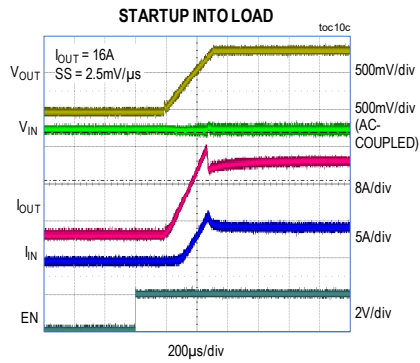

Typical Operating Characteristics (continued)

( $V_{SYS} = 3.8V$ ,  $V_{OUT} = 0.85V$ ,  $I_{OUT} = 0A$ , CE = high, 4-Phase (1 Output), FPWM = 0, LPM = 0, ETR = 0, L = 220nH,  $C_{OUT} = (22\mu F + 0.1\mu F + 2 \times 4.3\mu F)$ ,  $T_A = +25^\circ C$ , unless otherwise noted.)

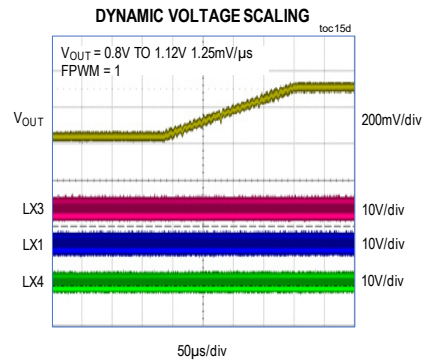
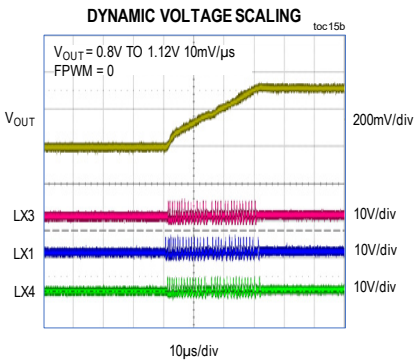
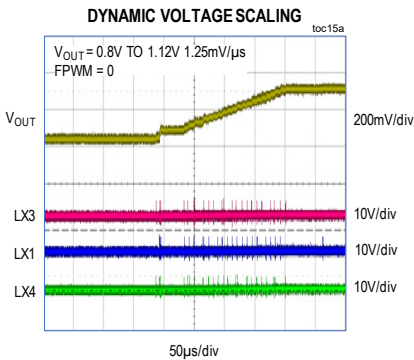
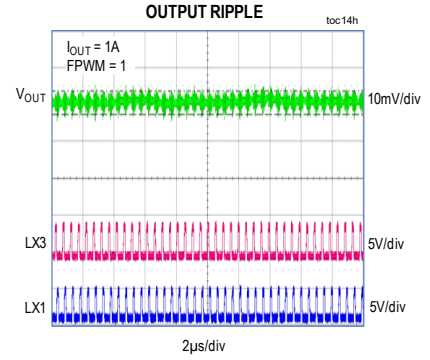
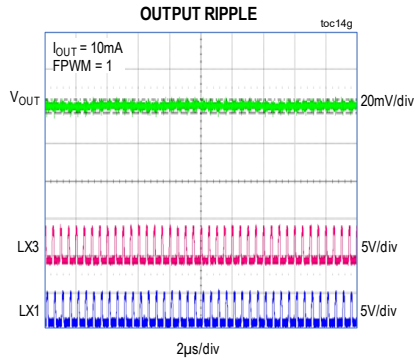
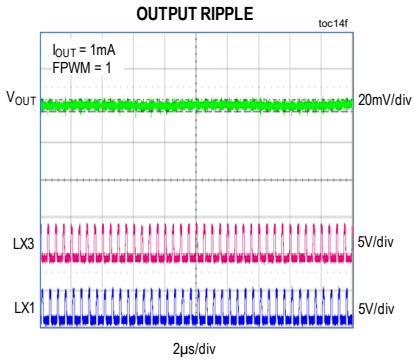
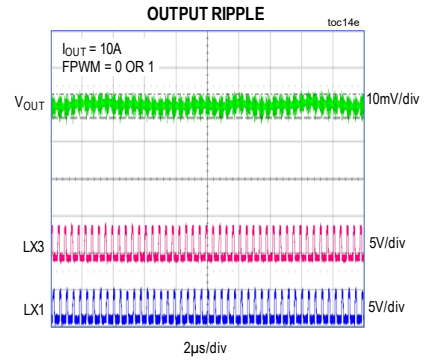
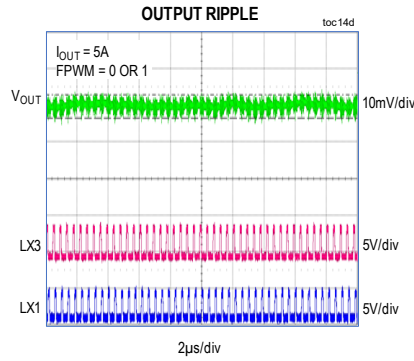
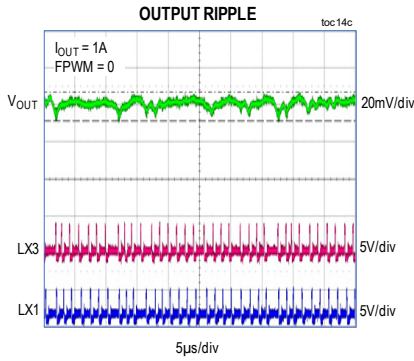

Typical Operating Characteristics (continued)

( $V_{SYS} = 3.8V$ ,  $V_{OUT} = 0.85V$ ,  $I_{OUT} = 0A$ , CE = high, 4-Phase (1 Output), FPWM = 0, LPM = 0, ETR = 0, L = 220nH,  $C_{OUT} = (22\mu F + 0.1\mu F + 2 \times 4.3\mu F)$ ,  $T_A = +25^\circ C$ , unless otherwise noted.)

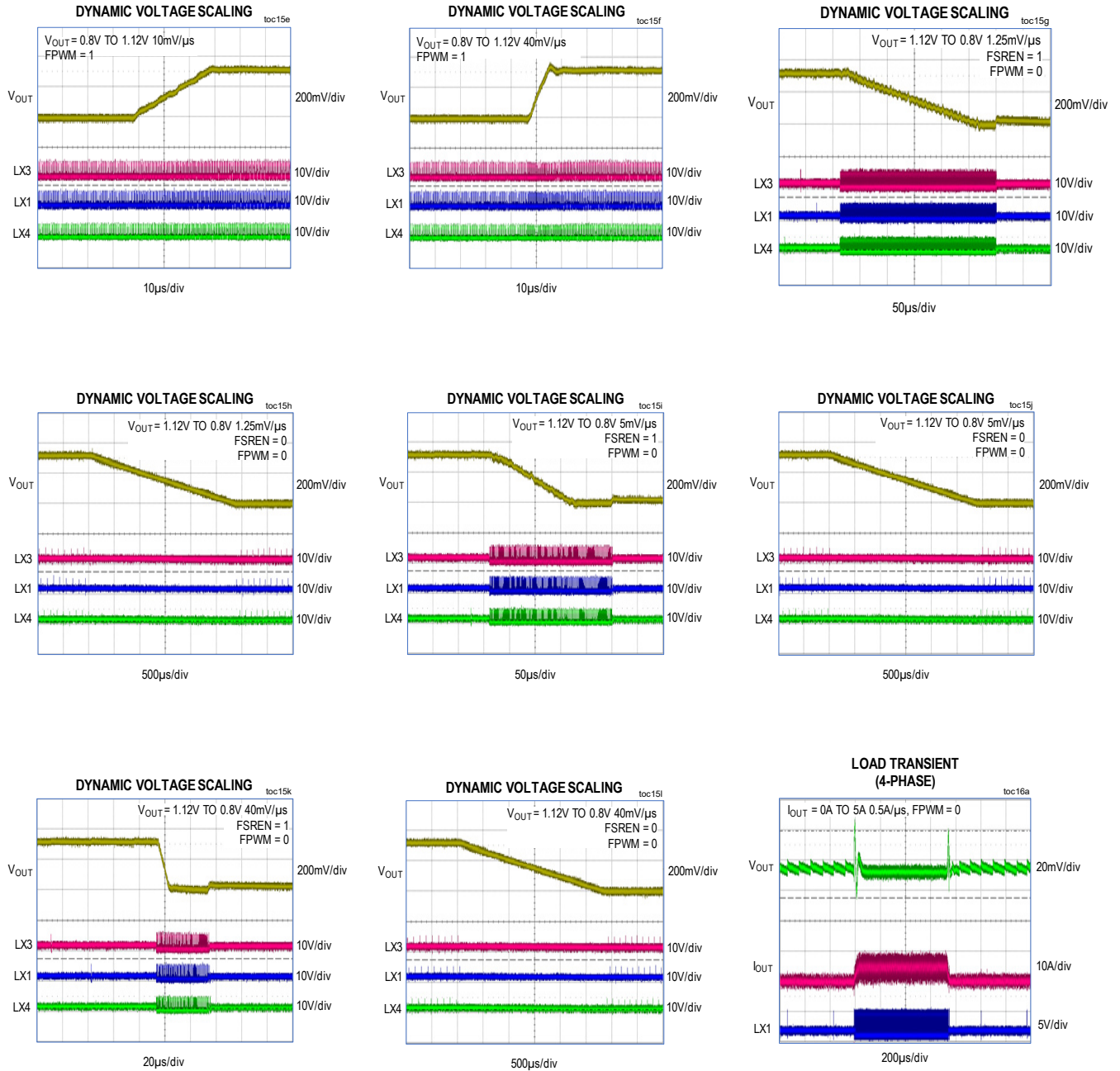

Typical Operating Characteristics (continued)

( $V_{SYS} = 3.8V$ ,  $V_{OUT} = 0.85V$ ,  $I_{OUT} = 0A$ , CE = high, 4-Phase (1 Output), FPWM = 0, LPM = 0, ETR = 0, L = 220nH,  $C_{OUT} = (22\mu F + 0.1\mu F + 2 \times 4.3\mu F)$ ,  $T_A = +25^\circ C$ , unless otherwise noted.)

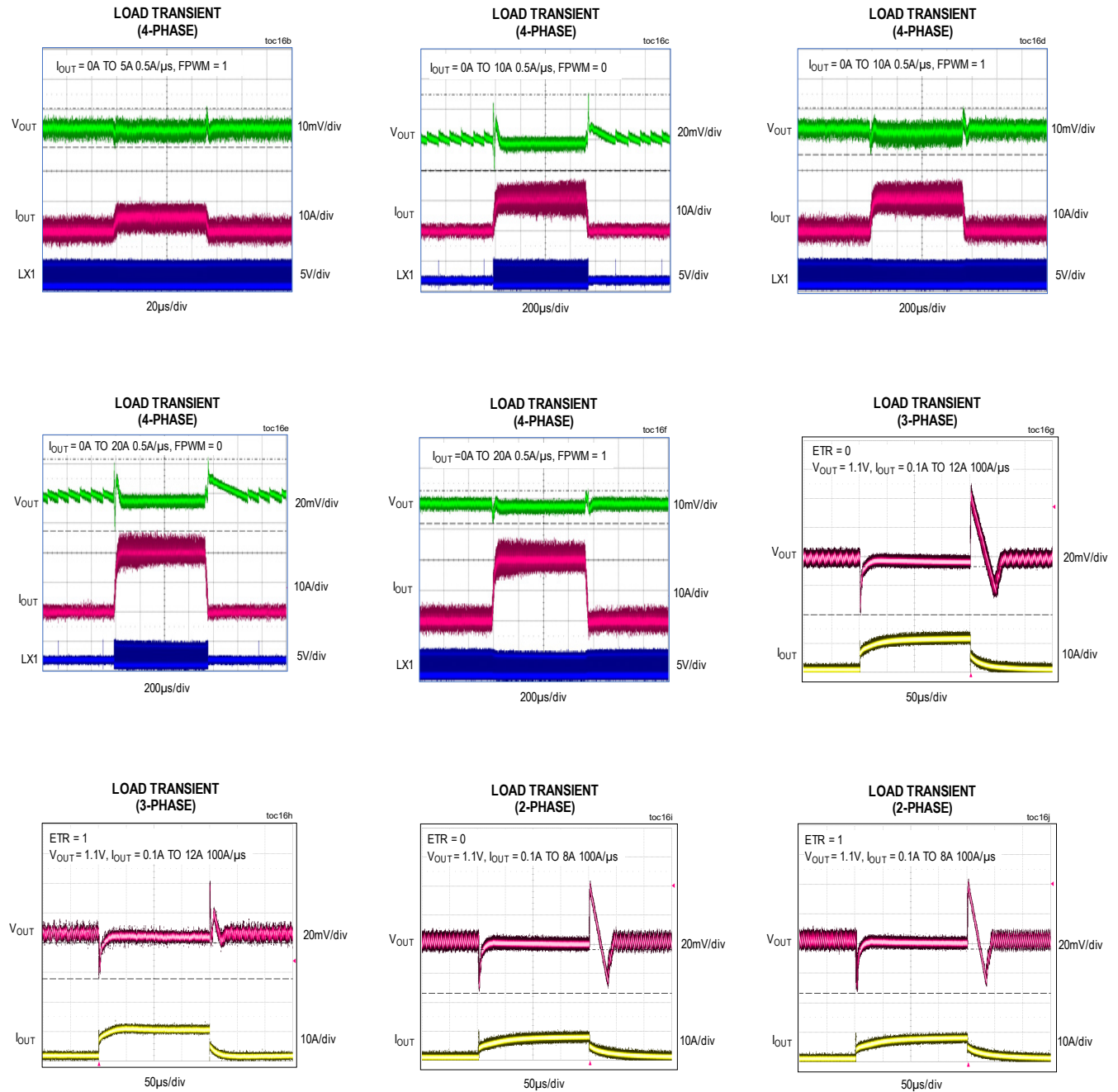

Typical Operating Characteristics (continued)

( $V_{SYS} = 3.8V$ ,  $V_{OUT} = 0.85V$ ,  $I_{OUT} = 0A$ , CE = high, 4-Phase (1 Output), FPWM = 0, LPM = 0, ETR = 0, L = 220nH,  $C_{OUT} = (22\mu F + 0.1\mu F + 2 \times 4.3\mu F)$ ,  $T_A = +25^\circ C$ , unless otherwise noted.)

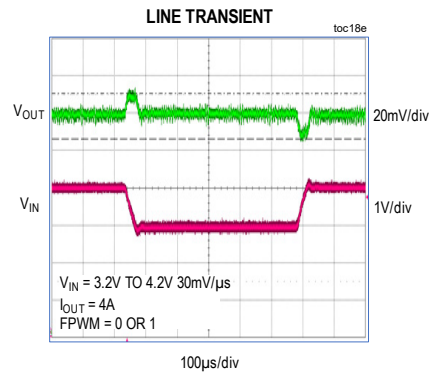
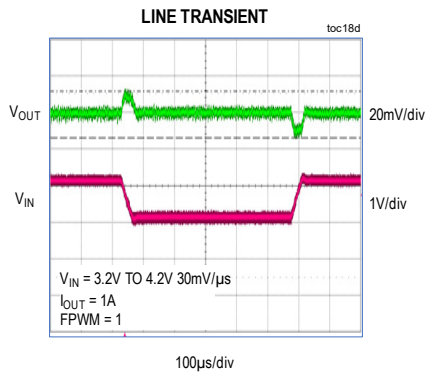
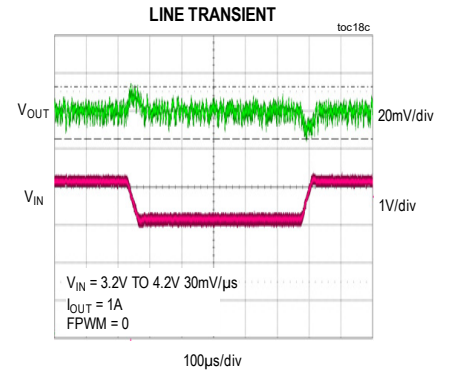
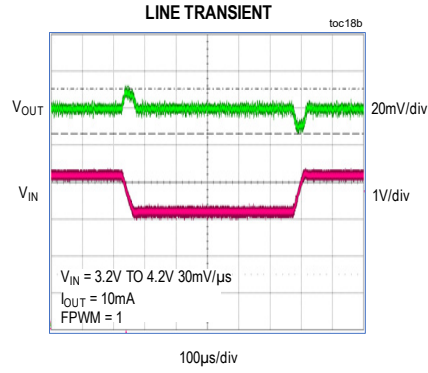
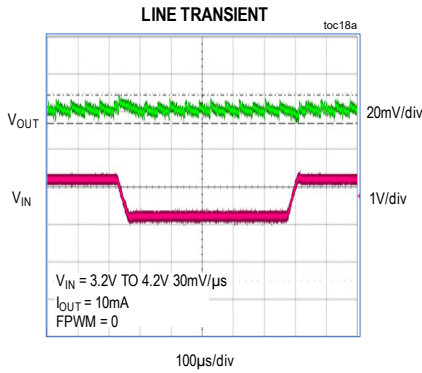
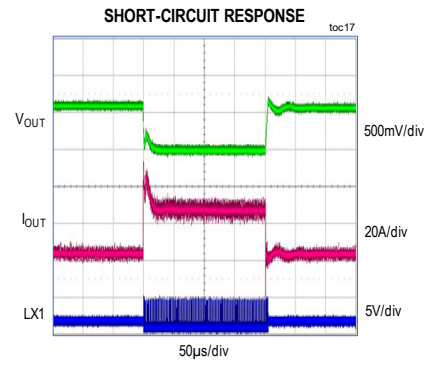
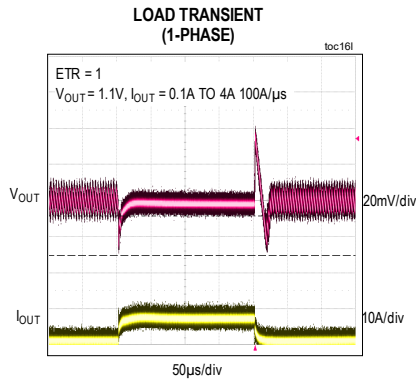
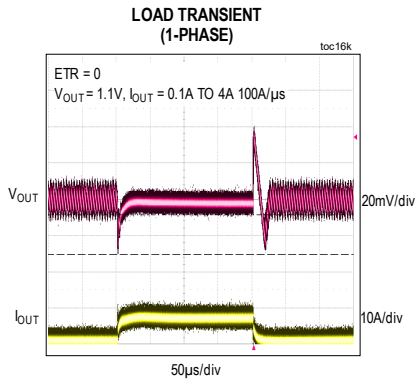

Bump Configuration

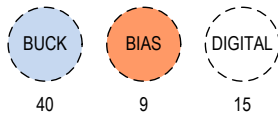

64 WLP (8 x 8 BUMP ARRAY, 0.4MM PITCH)

\*TOP VIEW = WAFER BACK-SIDE VIEW (BUMPS ARE NOT VIEWABLE)

## Bump Description

BUMP	NAME	FUNCTION
A1, B1, B2	PGND1	Phase1 Power Ground
A2, A3, B3	LX1	Phase1 Switch Node
A4, A5, B4, B5	IN12	Phase1/2 Input. Bypass to PGND1/2 with a 10 $\mu$ F capacitor.
A6, A7, B6	LX2	Phase2 Switch Node
A8, B7, B8	PGND2	Phase2 Power Ground
C1, C8, E5, E8, F1, F8	AGND	Analog Ground
C2	SNS1N	Phase1 Differential Negative Remote Sense Input
C3	$\overline{\text{IRQ}}$	Interrupt Output. A 100k $\Omega$ external pullup resistor to VIO is required. High impedance when CE = low.
C4	SNS1P	Phase 1 Differential Positive Remote Sense Input
C5	SNS2P	Phase 2 Differential Positive Remote Sense Input
C6	EN	Global Enable Input (Active-High, Logically ORed with GLB_EN Function of GPIOs). An 800k $\Omega$ internal pulldown resistance to DGND. If this pin is not used, leave it unconnected.
C7	SNS2N	Phase 2 Differential Negative Remote Sense Input
D1	SCL	I <sup>2</sup> C Clock Input. High impedance in off state. A 1.5k $\Omega$ ~2.2k $\Omega$ of pullup resistor to VIO is required.
D2	SCS	Active-Low SPI Chip Select
D3	VIO	IO Supply Voltage Input. Bypass to DGND with a 0.1 $\mu$ F capacitor.
D4	CE	Active-High Chip Enable Input. CE = High (standby), I <sup>2</sup> C interface is enabled and regulators are ready to be turned on. CE = Low (shutdown), all regulators are turned off and all Type-O registers are reset to their POR default values.
D5	WDTRSTB_IN	Active-Low Watchdog Timer Reset Input. An 800k $\Omega$ internal pullup resistance to VIO. If this pin is not used, leave it unconnected.
D6	LPM	Global Low Power Mode Input (Active-High, Logically ORed with GLB_LPM Function of GPIOs). An 800k $\Omega$ internal pulldown resistance to DGND. If this pin is not used, leave it unconnected.
D7	I2C_SPI_SEL	Serial Interface Selection Input. Latches at V <sub>SYS</sub> POR. I2C_SPI_SEL = Low: I <sup>2</sup> C I2C_SPI_SEL = High (V <sub>SYS</sub> ): SPI
D8	SYS	System (Battery) Voltage Input. Bypass to AGND with a 1 $\mu$ F capacitor.
E1	SDA/MOSI	I <sup>2</sup> C Data I/O. High Impedance in Off State. A 1.5k $\Omega$ ~2.2k $\Omega$ of pullup resistor to VIO is required. Configured as MOSI when SPI mode is selected.
E2	MISO	SPI Data Output. High impedance in off state.
E3	GPIO	Active-High, General-Purpose Input. An 800k $\Omega$ internal pulldown resistance to DGND. If this pin is not used, leave it unconnected.
E4	DGND	Digital Ground



## Bump Description (continued)

BUMP	NAME	FUNCTION
E6	PH_CFG0	Phase Configuration Selection Input. Latches at $V_{SYS}$ POR. PH_CFG2 = low, PH_CFG1 = low, PH_CFG0 = low: 4 phase PH_CFG2 = low, PH_CFG1 = low, PH_CFG0 = high ( $V_{SYS}$ ): 3 + 1 phase PH_CFG2 = low, PH_CFG1 = high ( $V_{SYS}$ ), PH_CFG0 = low: 2 + 2 phase PH_CFG2 = low, PH_CFG1 = high ( $V_{SYS}$ ), PH_CFG0 = high ( $V_{SYS}$ ): 2 + 1 + 1 phase PH_CFG2 = high ( $V_{SYS}$ ), PH_CFG1 = X, PH_CFG0 = X: 1 + 1 + 1 + 1 phase
E7	PH_CFG2	Phase Configuration Selection Input. Latches at $V_{SYS}$ POR. PH_CFG2 = low, PH_CFG1 = low, PH_CFG0 = low: 4 phase PH_CFG2 = low, PH_CFG1 = low, PH_CFG0 = high ( $V_{SYS}$ ): 3 + 1 phase PH_CFG2 = low, PH_CFG1 = high ( $V_{SYS}$ ), PH_CFG0 = low: 2 + 2 phase PH_CFG2 = low PH_CFG1 = high ( $V_{SYS}$ ), PH_CFG0 = high ( $V_{SYS}$ ): 2 + 1 + 1 phase PH_CFG2 = high ( $V_{SYS}$ ), PH_CFG1 = X, PH_CFG0 = X: 1 + 1 + 1 + 1 phase
F2	SNS4N	Phase 4 Differential Negative Remote Sense Input
F3	GPI1	Active-High, General-Purpose Input. An 800k $\Omega$ internal pulldown resistance to DGND. If this pin is not used, leave it unconnected.
F4	SNS4P	Phase 4 Differential Positive Remote Sense Input
F5	SNS3P	Phase 3 Differential Positive Remote Sense Input
F6	PH_CFG1	Phase Configuration Selection Input. Latches at $V_{SYS}$ POR. PH_CFG2 = low, PH_CFG1 = low, PH_CFG0 = low: 4 phase PH_CFG2 = low, PH_CFG1 = low, PH_CFG0 = high ( $V_{SYS}$ ): 3 + 1 phase PH_CFG2 = low, PH_CFG1 = high ( $V_{SYS}$ ), PH_CFG0 = low: 2 + 2 phase PH_CFG2 = low, PH_CFG1 = high ( $V_{SYS}$ ), PH_CFG0 = high ( $V_{SYS}$ ): 2 + 1 + 1 phase PH_CFG2 = high ( $V_{SYS}$ ), PH_CFG1 = X, PH_CFG0 = X: 1 + 1 + 1 + 1 phase
F7	SNS3N	Phase 3 Differential Negative Remote Sense Input
G1, G2, H1	PGND4	Phase 4 Power Ground
G3, H2, H3	LX4	Phase 4 Switch Node
G4, G5, H4, H5	IN34	Phase 3/4 Input. Bypass to PGND3/4 with a 10 $\mu$ F capacitor.
G6, H6, H7	LX3	Phase 3 Switch Node
G7, G8, H8	PGND3	Phase 3 Power Ground

## Detailed Description

### Top-Level System Management

#### System Faults

The MAX77812 monitors the system for the following faults:

- Undervoltage lockout
- VIO fault

#### Undervoltage Lockout

When the  $V_{SYS}$  voltage falls below  $V_{UVLO\_F}$  (2.15V typ), the MAX77812 enters into a shutdown state and UVLO forces the MAX77812 to a dormant state until  $V_{SYS}$  voltage rises above the UVLO rising threshold (typically 2.5V). Once the  $V_{SYS}$  voltage is higher than the UVLO rising threshold, the MAX77812 comes out of shutdown mode to be securely functional. The UVLO falling threshold is programmable through I<sup>2</sup>C, but it must be set lower than UVLO rising threshold to avoid unexpected behaviors.

#### VIO Fault

When the VIO supply falls below  $V_{TH\_VIO\_OK}$  (1.0V typ), the MAX77812 immediately goes into a shutdown state and stays in this mode until IO supply rises beyond  $V_{TH\_VIO\_OK}$  threshold.

#### Thermal Protection

The MAX77812 has a centralized thermal protection circuit which monitors temperature on the die. If the die temperature exceeds +165°C ( $T_{SHDN}$ ), the MAX77812 initiates a soft-stop for all the output(s) and all Type-O registers are reset to their POR default values. However, the MAX77812 should be able to communicate with the host processor through the serial interface as long as  $V_{SYS}$  and  $V_{VIO}$  supplies are within the operating range.

In case the die temperature drops by 15°C after the thermal protection occurs, the MAX77812 recovers to the normal state and the output(s) can be turned on again.

In addition to +165°C threshold, there are two additional comparators which trip at +120°C and +140°C. Interrupts are generated in the event the die temperature reaches +120°C or +140°C.

#### Reset Conditions

##### Power-On Reset (POR)

When a valid system supply voltage is applied to the device, the MAX77812 goes into shutdown mode and

stay there until CE goes high. As the  $V_{SYS}$  voltage rises above POR threshold ( $\approx 1.60V$ ), the internal reference and the integrated supply are enabled and the MAX77812 starts loading the default register values from the OTPs.

##### System Reset

When  $V_{SYS}$  voltage drops below its POR threshold ( $\approx 1.50V$ ), all Type-S1 registers are reset to their POR default values.

##### Off Reset

Off reset occurs by any power-off or shutdown events. This condition resets all Type-O registers to their POR default values.

##### Software Reset

All Type-O registers can be reset by writing '1' to SW\_RST bit in REG\_RESET register. This bit clears to '0' upon reset.

##### Watchdog Timeout Reset (WDTRSTB\_IN)

In case the host processor fails to reset its watchdog timer for any system issues, WDTRSTB\_IN signal goes low for about 100ms. When the MAX77812 detects that WDTRSTB\_IN is low longer than its debounce timer (programmable by WDT\_DEB[2:0]), the output voltage setting registers of all phases ( $Mx\_VOUT[7:0]$ ) reset to their POR default values and the output voltages return to their POR default values with given ramp-up/down slew rates.

##### Chip Enable (CE)

When  $V_{SYS}$  and  $V_{VIO}$  supplies are valid, a logic-high on CE pin puts the MAX77812 into standby mode (enabled). In standby mode, all user registers are accessible through I<sup>2</sup>C/SPI so that the host processor can overwrite the default output voltages of regulators and each regulator can be enabled by either I<sup>2</sup>C/SPI or GPI input if applicable.

When CE pin goes high, the MAX77812 turns on the internal bias circuitry which takes typically 50 $\mu$ s to be settled. As soon as the bias is ready, all the regulators are allowed to be turned on via I<sup>2</sup>C/SPI or EN pins. In case the regulators are enabled before the bias circuitry is ready, the regulators require longer time to startup.

When the CE pin is pulled low, the MAX77812 goes into shutdown mode (disabled) and turns off all the regulators regardless of EN pins. This event also resets all Type-O registers to their POR default values.

**Enable Control**

Each master phase of the MAX77812 can be enabled and disabled by a corresponding enable register bit (EN\_Mx), EN input and multifunction GPIs. The enable logic is an 'OR' logic of active enable logic signals. For example, the Master1 is enabled when EN\_M1 bit, GLB\_EN or M1\_EN logic signal is set to '1'. When all active signals are '0', the corresponding master phase is turned off.

**Startup and Shutdown Sequence**

The MAX77812 supports programmable startup and shutdown delay times between the master phases. The startup and shutdown sequence is initiated by either EN pin or GLB\_EN function of GPIs. The startup and shutdown delay times between the master phases are programmable from 0ms to 62ms (32 steps).

The startup sequence is set by OTP bits as well as STUP\_DLYx registers and the Master 1 is always turned on as soon as a startup sequence is initiated, while the shutdown sequence is programmable by SHDN\_DLYx registers only and the delay times for all master phases are programmable.

If any master phase(s) is(are) turned on by EN\_Mx bit or Mx\_EN input before initiating startup or shutdown, global startup or shutdown sequence does not affect the master phase(s) already turned on or off.

Figure 1 shows a typical startup and shutdown sequence.

For more detailed information on programming the sequencer, refer to [Application Note 6826: How to Program Startup and Shutdown Sequence with MAX77812](#).

**Immediate Shutdown Events**

The following events initiate an immediate shutdown:

- $V_{SYS} < \text{SYS UVLO falling threshold } (V_{UVLO\_F})$
- $V_{VIO} < \text{VIO OK threshold } (V_{TH\_VIO\_OK})$

The events in this category are associated with potentially hazardous system states. Powering down the host processor and resetting all Type-O registers help mitigate any issues that can occur due to these potentially hazardous conditions.

**Interrupt and Mask**

The  $\overline{\text{IRQ}}$  output is used to indicate to the host processor that the status on the MAX77812 has changed. The  $\overline{\text{IRQ}}$  output asserts (goes low) anytime an unmasked interrupt bit is triggered. The host processor reads the interrupt source register (ADDR 0x01) and the interrupt registers that are indicated by the interrupt source register to see the cause of interrupt event. Note that the interrupt source register is cleared when the corresponding interrupt register group is read by the host processor.

All the interrupt events are edge-triggered. Therefore, the same interrupt is not generated repeatedly even though the interrupt condition persists.

Each interrupt register can be read at a time and all interrupt bits are clear-on-read bits. The  $\overline{\text{IRQ}}$  output de-asserts (goes high) when all interrupt bits have been cleared. If an interrupt is captured during the read sequence,  $\overline{\text{IRQ}}$  output is held low. When  $\overline{\text{IRQ}}$  output is pulled low by an unmasked interrupt event,  $\overline{\text{IRQ}}$  output stays low until the interrupt bit is cleared by the reading operation of the host processor or the corresponding interrupt mask bit is set to '1' (masked).

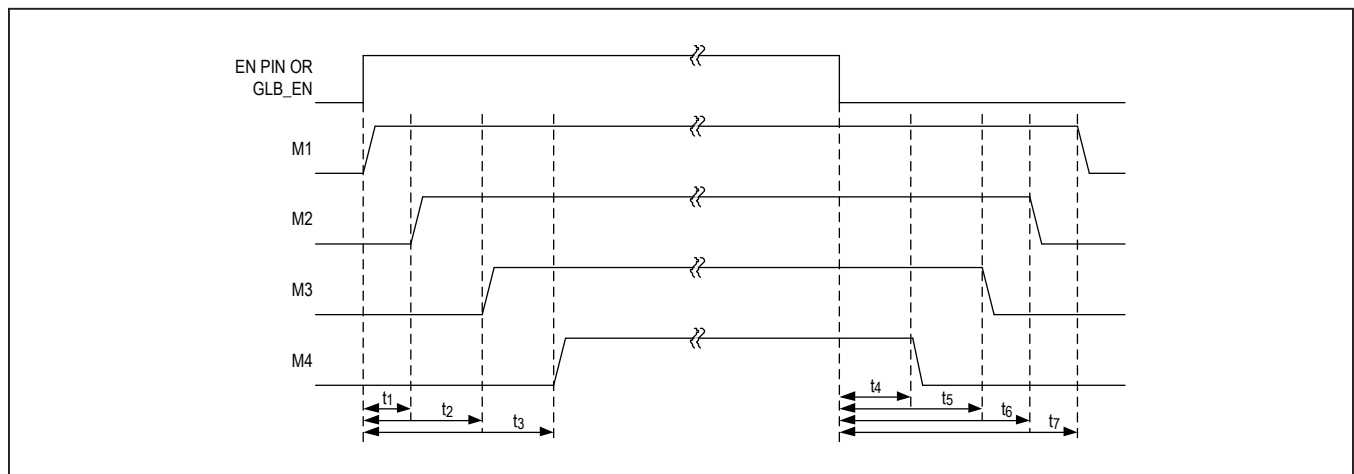

Figure 1. Startup and Shutdown Sequence

Each interrupt can be masked (disabled) by setting the corresponding interrupt mask register bit.

When the corresponding mask bit is set (masked), an interrupt bit is not set for an interrupt event. As a result, the  $\overline{\text{IRQ}}$  output stays high. When the mask bit is cleared, an active interrupt event at the time of clearing the mask bit is captured, which results in pulling the  $\overline{\text{IRQ}}$  output low.

Interrupt mask bits are set to '1' by default and are reset to the default values at power-off events.

### Status

In addition to interrupt bits, the MAX77812 has read-only STATUS bits. Those bits always represent the current status of the device. It is highly recommended that the host processor read STATUS bits whenever the MAX77812 is initialized by the host processor. These STATUS bits do not directly affect the state of interrupt bits.

### Quad-Phase Buck Regulator

The MAX77812 uses Maxim's proprietary Quick-PWM™ adaptive on-time control scheme. Adaptive on-time control provides fast response to load transients, inherent compensation to input voltage variation, and stable performance at low duty cycles. On-times (high-side MOSFET on) are controlled by the on-time generator circuit. This circuit calculates an on-time based on the input voltage ( $V_{\text{INx}}$ ), the output voltage ( $V_{\text{OUTx}}$ ), and the target switching frequency ( $F_{\text{SW}}$ ). The on-time is modified (slightly shortened or lengthened) by the phase current balancing control circuit. Off-times (low-side MOSFET on) begin when the on-time ends. Shoot-through current from INx to PGNDx is avoided by introducing a brief period of dead-time between switching events when neither MOSFET is on. During the dead-time, the inductor current conducts through the intrinsic body diode of the low-side MOSFET.

The PWM comparator regulates  $V_{\text{OUTx}}$  by modulating off-time. A compensation ramp is fed to the positive input of the PWM comparator and the negative input is a voltage proportional to the actual output voltage error added to the replicated AC current in the inductor. The PWM comparator begins an on-time (and resets the compensation ramp) when the error voltage plus replicated AC inductor current becomes greater than the ramp. When the calculated on-time expires, the off-time automatically begins. One PWM comparator is used to control all phases in multiphase configuration. The output is demultiplexed by a phase scheduler which controls the phase spacing of each switching stage (e.g., 2Φ is spaced 180° apart, 3Φ is spaced 120°, 4Φ is spaced 90°). Multiphase configurations permanently have all phases activated and always switches in sequence during steady-state operation (phases do not add or shed).

The switching frequency ( $F_{\text{SW}}$ ) of the adaptive on-time BUCK is variable and heavily influenced by the instantaneous load. More on-time pulses in a given time (higher  $F_{\text{SW}}$ ) is observed as load increases. Fewer on-times in a given time (lower  $F_{\text{SW}}$ ) is observed as load decreases.

### Phase/Output Configurations

The MAX77812 supports user-programmable phase configuration by PH\_CFG0, PH\_CFG1 and PH\_CFG2 input logic state. The input logic state is latched at the POR event.

All supported phase configurations are shown in [Table 1](#). Refer to [Application Note 6804: Guidelines for the MAX77812 User-Selectable Phase Configurations and How to Select Them](#) for a concise summary of all the information regarding phase configurations found in this data sheet.

**Table 1. User-Programmable Phase/Output Configurations**

PH_CFG2	PH_CFG1	PH_CFG0	PHASE CONFIGURATION
Low	Low	Low	1 Output: 4-Phase (Master 1)
Low	Low	High	2 Outputs: 3-phase (Master 1) + 1-phase (Master 4)
Low	High	Low	2 Outputs: 2-phase (Master 1) + 2-phase (Master 3)
Low	High	High	3 Outputs: 2-phase (Master 1) + 1-phase (Master 3) + 1-phase (Master 4)
High	X	X	4 Outputs: 1-phase (Master 1) + 1-phase (Master 2) + 1-phase (Master 3) + 1-phase (Master 4)

Based on the selected phase configuration, the phase selector generates the TON signals to each power stage with different phase interleaving schemes and the master phases are assigned as shown in [Figure 2](#).

Note that only registers for the master phase(s) are activated and the slave phase(s) are controlled by the corresponding master phase(s).

**SKIP/Forced PWM Operation**

In normal operating mode, buck automatically transitions from skip mode to fixed frequency operation as the load current increases. For operating modes where lowest output ripple is required, Forced PWM switching behavior can be enabled by writing ‘1’ to Mx\_FPWM bit.

**Low Power Mode**

Each master includes LPM (low power mode) operation to minimize the quiescent current when the host processor is in sleep state. In LPM, the ETR (enhanced transient response), ADT (adaptive dead-time control), and  $\overline{\text{POK}}$  comparator (POK = high) are disabled so that load transient response of the buck regulators are derated as the trade-off. The LPM of each master can be enabled independently by Mx\_LPM bits.

**Startup and Soft-Start**

When starting up buck regulator, the bias circuitry must be enabled and provided with adequate time to settle. The bias circuitry is guaranteed to settle within 250µs, at which time, the buck regulators power-up sequence can commence. Note that attempting to implement a power-up sequence before the BIASOK signal is generated results in all enabled regulators starting up at the same time.

The buck regulator supports starting into a prebiased output. For example, if the output capacitor has an initial volt-

age of 0.4V when the regulator is enabled, the regulator gracefully increases the capacitor voltage to the required target voltage such as 1.0V. This is unlike other regulators without the start into prebias feature where they can force the output capacitor voltage to 0V before the soft-start ramp begins.

The buck regulator supports programmable soft-start rate from 1.25mV/µs to 60mV/µs. The controlled soft-start rate and buck regulator current limit (ILIM\_PEAK) limit the input inrush current to the output capacitor (IINRUSH).  $IINRUSH = \min(ILIM\_PEAK \ \& \ COUT \times \ dv/dt)$ . Note that the input current of the buck regulator is lower than the inrush current to the output capacitor by the ratio of output to input voltage.

**Output Voltage Setting**

The output voltage is programmable from 0.25V to 1.525V in 5mV steps to allow fine adjustment to the processor supply voltage under light load conditions to minimize power loss within the processor. Each master phase have three output voltage control registers. Mx\_VOUT[7:0] register is for normal operation and Mx\_VOUT\_D[7:0] and Mx\_VOUT\_S[7:0] are used for voltage selection function by GPIx. See the \*Multifunction GPIs\* section. The default output voltages are set by an OTP option at the factory. The default output voltages can be overwritten by changing the contents in Mx\_VOUT[7:0] register prior to enabling the regulator.

For some applications, an output voltage higher than 1.525V is required. The MAX77812 supports higher output voltage with the addition of an external voltage-divider network. For more details, refer to [Application Note 6823: Generating a Higher Output Voltage than 1.525V Using the MAX77812](#).

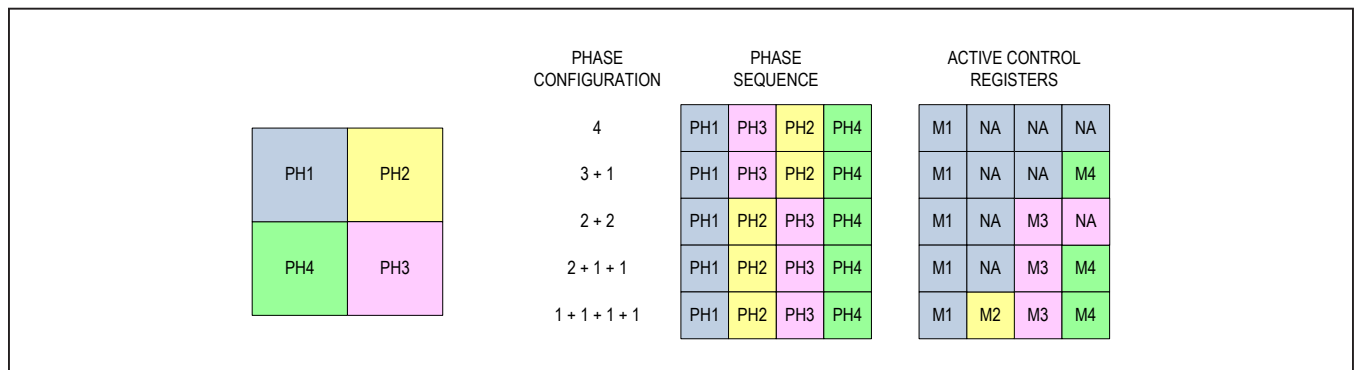

Figure 2. Buck Phase Configuration

### Changing Output Voltage During Operation

In a typical smartphone or tablet application, there are several power domains in which the operating frequency of the processor is increased or decreased (DVFS). When the operating frequency needs to be changed, it is expected that the buck regulator responds to a command to change the output voltages to new target values quickly. The high peak current limit, coupled with low inductance and small output capacitance, allows the buck regulator to respond to a positive step change in output voltage and settle to the new target value quickly. The buck regulator provides programmable ramp-up slew rates to accommodate different requirements.

For a negative step change in output voltage, the settling time is not critical. In Forced PWM mode (either Mx\_FPWM bit or Mx\_FSREN bit is enabled), the negative inductor current through NMOS discharges energy from the output capacitor, which helps the output voltage to decrease to the new target value faster. In skip mode, the negative inductor current is not allowed so that the output voltage settling time is dependent on the load current and the output capacitance.

### Output Voltage Slew Rate Control

The buck regulator supports programmable slew rate control feature when increasing and decreasing the output voltage. The ramp-up slew rate can be set to 1.25mV/ $\mu$ s, 2.5mV/ $\mu$ s, 5mV/ $\mu$ s, 10mV/ $\mu$ s, 20mV/ $\mu$ s, 40mV/ $\mu$ s or 60mV/ $\mu$ s independently via B\_RU\_SR[2:0] bits, while the ramp-down slew rate is programmable to 1.25mV/ $\mu$ s, 2.5mV/ $\mu$ s, 5mV/ $\mu$ s, 10mV/ $\mu$ s, 20mV/ $\mu$ s, 40mV/ $\mu$ s or 60mV/ $\mu$ s through B\_RD\_SR[2:0].

### Remote Output Voltage Sensing

All phases support differential remote output voltage sensing feature for improving point of load regulation. Differential feedback (SNSxP and SNSxN) enables voltage sensing directly at the point of load, ensuring best voltage regulation at the load, regardless of power plane impedances.

### Output Active Discharge

BUCK provides an internal 100 $\Omega$  resistor for output active discharge function. If the active discharge function is enabled (Mx\_AD = 1), the internal resistor discharges the energy stored in the output capacitor to PGNDx whenever the regulator is disabled.

Either the regulator remains enabled or the active discharge function is disabled (Mx\_AD = 0), the internal resistor is disconnected from the output. If the active discharge function is disabled, the output voltage decays at a rate that is determined by the output capacitance and the load current when the regulator is turned off.

### Enhanced Transient Response

The MAX77812 features the enhanced transient response (ETR) function to improve the output-voltage transient responses with very fast load changes. When enabled, the ETR function monitors the output voltage and detects high dv/dt undershoot and overshoot separately.

When the negative ETR (NETR) is detected during output-voltage undershoot, the buck controllers turn on all master and slave phases assigned to the same output at the same time (in-phase) until the NETR is de-asserted. This allows the multi-phase buck converters (no significant impact on single-phase buck) to pump up energy to the output in order to recover from the undershoot quickly.

When the positive ETR (PETR) is detected, the buck controllers turn off the corresponding low-side MOSFETs to discharge excessive energy stored in the inductors, which results in suppressing output-voltage overshoot. When the PETR is released, the buck controllers operate in FPWM mode for about 5ms before returning to normal operation.

Both NETR and PETR functions are enabled by default, but they can be turned off to reduce quiescent current by clearing the B\_NETR\_EN and B\_PETR\_EN bits in the GLB\_CFG3 register.

### Inductor Selection

The buck regulator is optimized for 220nH to 470nH inductors. The lower the inductor DCR, the higher the buck efficiency is. Users need to trade off inductor size with DCR value and choose a suitable inductor for the buck.

### Inductor Current Limit

A cycle-by-cycle current limit provides overcurrent protection by monitoring the current in the high-side and low-side MOSFETs. The peak current limit ( $I_{PLIM}$ ) triggers during on-time and prevents the inductor current from running away. If  $I_{PLIM}$  trips, the on-time ends and the low-side MOSFET turns on to reduce the inductor current until it hits the valley current limit ( $I_{VLIM}$ ). Once the current falls to  $I_{VLIM}$ , normal operation resumes. Note that the buck output current is limited to  $(I_{PLIM} + I_{VLIM})/2$ . For more detailed information, refer to [Application Note 6820: How Overcurrent Protections Works in the MAX77812](#).

### Input and Output Capacitor Selection

The input capacitor,  $C_{IN}$ , reduces the current peaks drawn from the battery or input power source and reduces switching noise in the device. The impedance of  $C_{IN}$  at the switching frequency should be kept very low. Ceramic capacitors with X5R or X7R dielectrics are highly recommended due to their small size, low ESR, and small temperature coefficients. For most applications a 10 $\mu$ F capacitor is sufficient.

The output capacitor,  $C_{OUT}$ , is required to keep the output voltage ripple small and to ensure regulation loop stability.  $C_{OUT}$  must have low impedance at the switching frequency. Ceramic capacitors with X5R or X7R dielectric are highly recommended due to their small size, low ESR, and small temperature coefficients. Due to the unique feedback network, the output capacitance can be very low. The recommended minimum output capacitance per phase is 22 $\mu$ F.

**Table 2. Suggested Inductors**

MFGR.	SERIES	NOMINAL INDUCTANCE (nH)	TYPICAL DC RESISTANCE (m $\Omega$ )	CURRENT RATING (A) -30% ( $\Delta L/L$ )	CURRENT RATING [A] $\Delta T = +40^{\circ}C$ RISE	DIMENSIONS L x W x H (mm)
Cyntec	HMLE20161B-R22MDR	220	13	5.8	5.3	2.0 x 1.6 x 1.2
TOKO	DFE201610-E-R24N	240	16	7.0	5.5	2.0 x 1.6 x 1.0
ALPS	GLULMR2201A	220	9	6.5	7.0	2.5 X 2.0 X 1.2

**Table 3. Suggested Capacitors**

MFGR.	SERIES	NOMINAL CAPACITANCE ( $\mu$ F)	RATED VOLTAGE (V)	TEMPERATURE CHARACTERISTICS	CASE SIZE (Imperial)	DIMENSIONS L x W x H (mm)
Murata	GRM188R60J106ME84	10 $\pm$ 20%	6.3	X5R	0603	1.6 x 0.8 x 0.8
Murata	GRM188R60J226MEA0	22 $\pm$ 20%	6.3	X5R	0603	1.6 x 0.8 x 0.8

### Unused Outputs

Follow these guidelines when the application has unused buck outputs:

- Connected unused inputs (INx) to SYS.
- Leave unused LXx pins unconnected (open).
- Connect unused SNSxN and PGNDx pins to ground.
- Connect unused SNSxP pins to either input or ground, depending on the state of the unused output in the application:
  - If the unused output can be enabled at any point in the application, either by the global enable input pin (EN) or a GPIx set to be a global enable, **connect the unused SNSxP to INx**.
  - If the unused output is disabled by default and will never be enabled, **connect the unused SNSxP to ground**.

Do not confuse unused outputs with unused phases. Phases configured under a master controller in a multi-phase configuration must connect according to [Table 1](#).

If possible, do not enable unused outputs. An unused output with a floating LX pin might try switching the LX node indefinitely (depending on the SNSxP connection), which wastes supply current.

### PCB Trace Resistance

The evaluation kit (and the typical PCB on which the MAX77812 is expected to be designed in) utilize 1/3oz. Cu, which is plated up to 0.5oz. 0.5oz. Cu has a typical resistance of 1m $\Omega$  per square.

**Table 4. Multifunction GPI Configurations**

GPIx_FUNC[3:0]	FUNCTION	REMARK
0000b	GLB_EN	Global Enable (Master 1 through Master 4)
0001b	M1_EN	Master 1 Enable
0010b	M2_EN	Master 2 Enable
0011b	M3_EN	Master 3 Enable
0100b	M4_EN	Master 4 Enable
0101b	GLB_VSEL	Global Voltage Selection (Master 1 through Master 4)
0110b	M1_VSEL	Master 1 Voltage Selection
0111b	M2_VSEL	Master 2 Voltage Selection
1000b	M3_VSEL	Master 3 Voltage Selection
1001b	M4_VSEL	Master 4 Voltage Selection
1010b	GLB_LPM	Global Low Power Mode Select (Master 1 through Master 4)
1011b	M1_LPM	Master 1 Low Power Mode Enable
1100b	M2_LPM	Master 2 Low Power Mode Enable
1101b	M3_LPM	Master 3 Low Power Mode Enable
1110b	M4_LPM	Master 4 Low Power Mode Enable
1111b	No function	—

## Multifunction GPIs

### General Description

The MAX77812 has two general purpose inputs (GPIO and GPI1) that can be configured as the enable of regulators, the output voltage selection, the low power mode control and no function. The function of these two inputs is programmable through I<sup>2</sup>C/SPI (GPI\_FUNC register) on the fly. [Application Note 6822: How to Use Multifunction GPIs?](#) provides an in-depth look at programming the GPIs for their various functions.

### Enable Control by GPI

When the GPIx are configured as output enable pins, the enable logic of a specific regulator is an 'OR' logic of the GPIx and the corresponding enable register bit (Mx\_EN). For example, if GPIO\_FUNC[3:0] = 0001b, the buck Master 1 enable is controlled by GPIO and M1\_EN bit.

In case the two GPIs are configured as the same enable function (i.e., GPIO\_FUNC[3:0] = GPI1\_FUNC[3:0] = 0010b), those inputs are ORed with M2\_EN bit. GLB\_EN function (GPIO\_FUNC[3:0] = 0000b) allows the host processor to enable all the masters in sequence based on STUP\_DLYx registers. Note that M1 thru M4 are defined by PH\_CFG0, PH\_CFG1 and PH\_CFG2 inputs.

### Voltage Selection by GPI

The buck has two additional output voltage control registers (Mx\_VOUT\_D[7:0] and Mx\_VOUT\_S[7:0]) besides one (Mx\_VOUT[7:0]) for normal operation. Those two additional registers are for storing the default output voltage and the system sleep mode output voltage for a specific host processor.

When GPIx are configured as voltage selection pins, the output voltage of a specific regulator is set by Mx\_VOUT\_D[7:0] and Mx\_VOUT\_S[7:0] registers based on the input logic. For example, if GPIO\_FUNC[3:0] = 0101b, the output voltages of all the masters are set by Mx\_VOUT\_D[7:0] and Mx\_VOUT\_S[7:0] when GPIO = high and GPI0 = low, respectively. In case the two GPIs are configured as the same voltage selection function, those inputs are ORed. During the output voltage transition, the ramp-up/down slew rate is controlled by B\_RU\_SR[2:0] and B\_RD\_SR[2:0]. Note that M1 thru M4 are defined by PH\_CFG0, PH\_CFG1 and PH\_CFG2 inputs.

### Low Power Mode by GPI

When GPIx are configured as low power mode enable pins, the low power mode enable logic of a specific regulator is an 'OR' logic of GPIx and the corresponding enable register bit (Mx\_LPM). For example, if GPIO\_FUNC[3:0] = 1011b, the buck Master 1 low power mode enable is controlled by GPIO and M1\_LPM bit.



In case the two GPIOs are configured as the same enable function (i.e., GPIO\_FUNC[3:0] = GPIO\_FUNC[3:0] = 1100b), those inputs are ORed with M2\_LPM bit. GLB\_LPM function (GPIO\_FUNC[3:0] = 1010b) allows the host processor to enable low power mode of all the masters at the same time. Note that M1 thru M4 are defined by PH\_CFG0, PH\_CFG1, and PH\_CFG2 inputs.

### I<sup>2</sup>C Serial Interface

#### General Description

The I<sup>2</sup>C-compatible 2-wire serial interface is used for regulator on/off control, setting output voltages, and other functions. See the [Register Map](#) section for details.

The I<sup>2</sup>C serial bus consists of a bidirectional serial-data line (SDA) and a serial clock (SCL). I<sup>2</sup>C is an open-drain bus. SDA and SCL require pullup resistors (500Ω or greater). Optional 24Ω resistors in series with SDA and SCL help to protect the device inputs from high voltage spikes on the bus lines. Series resistors also minimize crosstalk and undershoot on bus lines.

#### System Configuration

The I<sup>2</sup>C bus is a multimaster bus. The maximum number of devices that can attach to the bus is only limited by bus capacitance.

Figure 3 shows an example of a typical I<sup>2</sup>C system. A device on I<sup>2</sup>C bus that sends data to the bus is called a transmitter. A device that receives data from the bus is called a receiver. The device that initiates a data transfer and generates SCL clock signals to control the data transfer is a master. Any device that is being addressed by the master is considered a slave. When the MAX77812 I<sup>2</sup>C-compatible interface is operating, it is a slave on I<sup>2</sup>C bus and it can be both a transmitter and a receiver.

#### Bit Transfer

One data bit is transferred for each SCL clock cycle. The data on SDA must remain stable during the high portion of SCL clock pulse. Changes in SDA while SCL is high are control signals (START and STOP conditions).

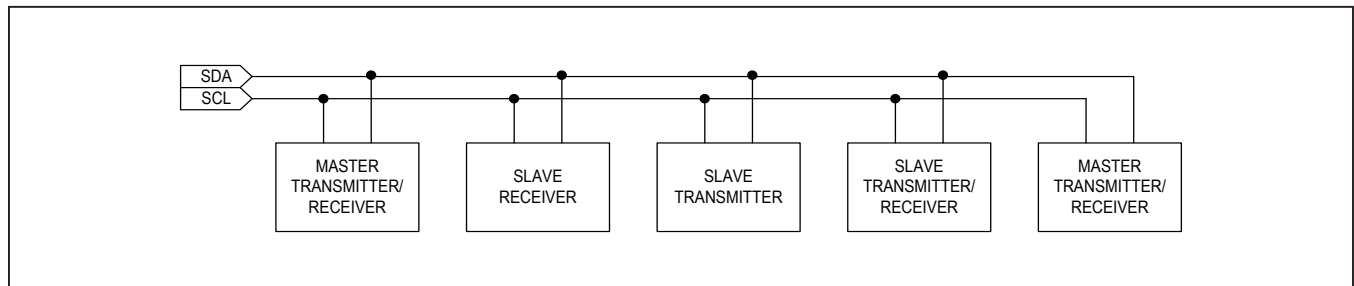

Figure 3. Functional Logic Diagram for Communications Controller

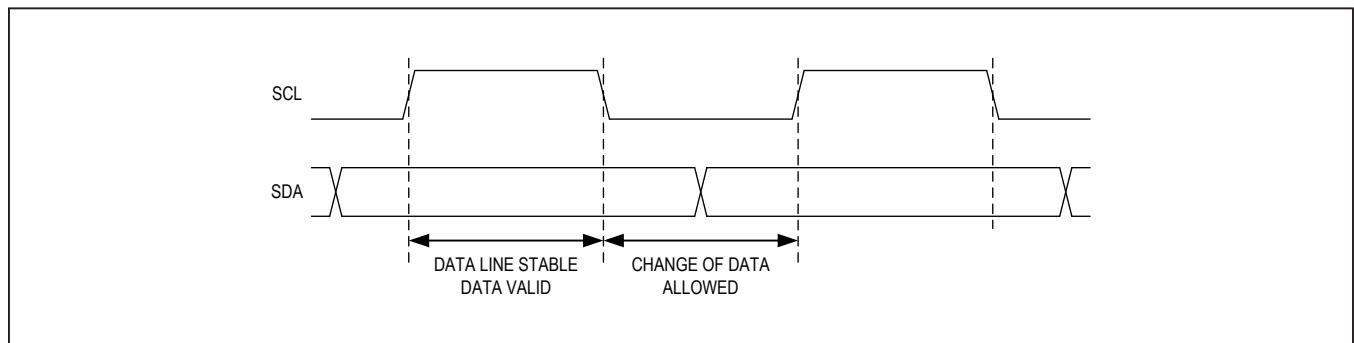

Figure 4. I<sup>2</sup>C Bit Transfer

**START and STOP Conditions**

When I<sup>2</sup>C serial interface is inactive, SDA and SCL idle high. A master device initiates communication by issuing a START condition. A START condition is a high-to-low transition on SDA with SCL high. A STOP condition is a low-to-high transition on SDA, while SCL is high.

A START condition from the master signals the beginning of a transmission to the MAX77812. The master terminates transmission by issuing a NOT ACKNOWLEDGE followed by a STOP condition.

A STOP condition frees the bus. To issue a series of commands to the slave, the master can issue REPEATED START (Sr) commands instead of a STOP command in order to maintain control of the bus. In general, a REPEATED START command is functionally equivalent to a regular START command.

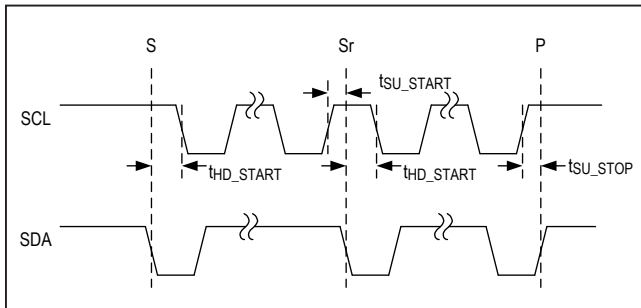

Figure 5. I<sup>2</sup>C Start Stop

When a STOP condition or incorrect address is detected, the MAX77812 internally disconnects SCL from I<sup>2</sup>C serial interface until the next START condition, minimizing digital noise and feedthrough.

**Acknowledge**

Both the I<sup>2</sup>C bus master and the MAX77812 (slave) generate acknowledge bits when receiving data. The acknowledge bit is the last bit of each nine bit data packet. To generate an ACKNOWLEDGE (A), the receiving device must pull SDA low before the rising edge of the acknowledge-related clock pulse (ninth pulse) and keep it low during the high period of the clock pulse. To generate a NOT ACKNOWLEDGE (nA), the receiving device allows SDA to be pulled high before the rising edge of the acknowledge-related clock pulse and leaves it high during the high period of the clock pulse.

Monitoring the acknowledge bits allows for detection of unsuccessful data transfers. An unsuccessful data transfer occurs if a receiving device is busy or if a system fault has occurred. In the event of an unsuccessful data transfer, the bus master should reattempt communication at a later time.

**Slave Address**

The I<sup>2</sup>C slave address is set by buck phase configuration as shown in Table 5. If two MAX77812 devices with the same phase configuration need to be connected to the same I<sup>2</sup>C bus, contact a Maxim representative.

**Table 5. I<sup>2</sup>C Slave Address**

PH_CFG2	PH_CFG1	PH_CFG0	SLAVE ADDRESS (7-BIT)	SLAVE ADDRESS (WRITE)	SLAVE ADDRESS (READ)
<b>MAX77812EWB+, MAX77812AEWB+, MAX77812BEWB+, MAX77812CEWB+, MAX77812DEWB+</b>					
Low	Low	Low	011 0000	0x60 (0110 0000)	0x61 (0110 0001)
Low	Low	High	011 0001	0x62 (0110 0010)	0x63 (0110 0011)
Low	High	Low	011 0010	0x64 (0110 0100)	0x65 (0110 0101)
Low	High	High	011 0011	0x66 (0110 0110)	0x67 (0110 0111)
High	X	X	011 0100	0x68 (0110 1000)	0x69 (0110 1001)
<b>MAX77812FEWB+</b>					
Low	Low	Low	011 1000	0x70 (0111 0000)	0x71 (0111 0001)
Low	Low	High	011 1001	0x72 (0111 0010)	0x73 (0111 0011)
Low	High	Low	011 1010	0x74 (0111 0100)	0x75 (0111 0101)
Low	High	High	011 1011	0x76 (0111 0110)	0x77 (0111 0111)
High	X	X	011 1100	0x78 (0111 1000)	0x79 (0111 1001)

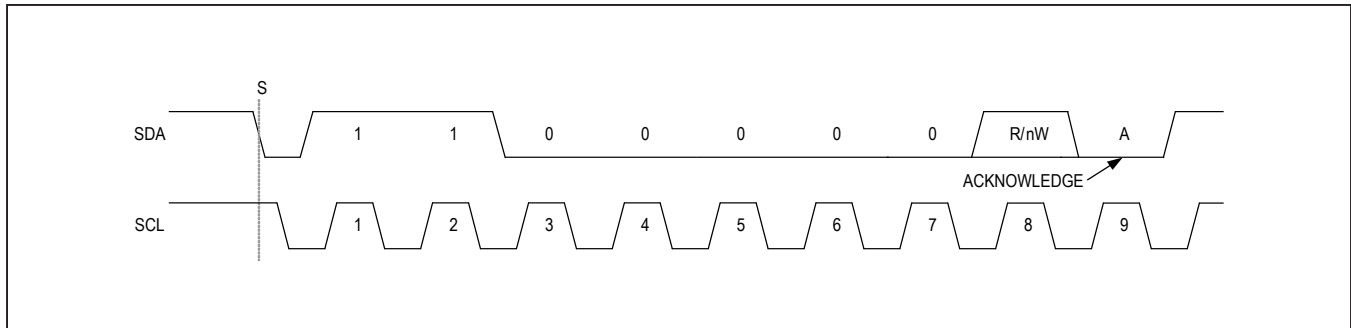

Figure 6. Slave Address Byte Example

### Clock Stretching

In general, the clock signal generation for I<sup>2</sup>C bus is the responsibility of the master device. I<sup>2</sup>C specification allows slow slave devices to alter the clock signal by holding down the clock line. The process in which a slave device holds down the clock line is typically called clock stretching. The MAX77812 does not use any form of clock stretching to hold down the clock line.

### General Call Address

The MAX77812 does not implement the I<sup>2</sup>C specification general call address. If the MAX77812 sees general call address (00000000b), it does not issue an ACKNOWLEDGE (A).

### Communication Speed

The MAX77812 provides an I<sup>2</sup>C 3.0-compatible (3.4MHz) serial interface.

- I<sup>2</sup>C Revision 3 Compatible Serial Communications Channel
  - 0Hz to 100kHz (Standard Mode)
  - 0Hz to 400kHz (Fast Mode)
  - 0Hz to 1MHz (Fast Mode Plus)
  - 0Hz to 3.4MHz (High-speed Mode)
- Does not utilize I<sup>2</sup>C Clock Stretching

Operating in standard mode, fast mode and fast mode plus does not require any special protocols. The main consideration when changing the bus speed through this range is the combination of the bus capacitance and pullup resistors. Higher time constants created by the

bus capacitance and pullup resistance ( $C \times R$ ) slow the bus operation. Therefore, when increasing bus speeds the pullup resistance must be decreased to maintain a reasonable time constant. See the *Pullup Resistor Sizing* section of the I<sup>2</sup>C revision 3.0 specification for detailed guidance on the pullup resistor selection. In general, for bus capacitance of 200pF, a 100kHz bus needs 5.6k $\Omega$  pullup resistors, a 400kHz bus needs about a 1.5k $\Omega$  pullup resistors, and a 1MHz bus needs 680 $\Omega$  pullup resistors. Note that the pullup resistor is dissipating power when the open-drain bus is low. The lower the value of the pullup resistor, the higher the power dissipation ( $V^2/R$ ).

Operating in high-speed mode requires some special considerations. For the full list of considerations, see the I<sup>2</sup>C 3.0 specification. The major considerations with respect to the MAX77812 are:

- I<sup>2</sup>C bus master use current source pullups to shorten the signal rise times.
- I<sup>2</sup>C slave must use a different set of input filters on its SDA and SCL lines to accommodate for the higher bus speed.
- The communication protocols need to utilize the high-speed master code.

At power-up and after each STOP condition, the MAX77812 inputs filters are set for standard mode, fast mode, or fast mode plus (i.e., 0Hz to 1MHz). To switch the input filters for high-speed mode, use the high-speed master code protocols that are described in the *Protocols* section.

**Communication Protocols**

The MAX77812 supports both writing and reading from its registers.

**Writing to a Single Register**

Figure 7 shows the protocol for I<sup>2</sup>C master device to write one byte of data to the MAX77812. This protocol is the same as SMBus specification's write byte protocol.

The write byte protocol is as follows:

- 1) The master sends a START command (S).
- 2) The master sends the 7-bit slave address followed by a write bit (R/W = 0).
- 3) The addressed slave asserts an ACKNOWLEDGE

- (A) by pulling SDA low.
- 4) The master sends an 8-bit register pointer.
- 5) The slave acknowledges the register pointer.
- 6) The master sends a data byte.
- 7) The slave acknowledges the data byte. At the rising edge of SCL, the data byte is loaded into its target register and the data becomes active.
- 8) The master sends a STOP condition (P) or a REPEATED START (Sr). Issuing a P ensures that the bus input filters are set for 1MHz or slower operation. Issuing a REPEATED START (Sr) leaves the bus input filters in their current state.

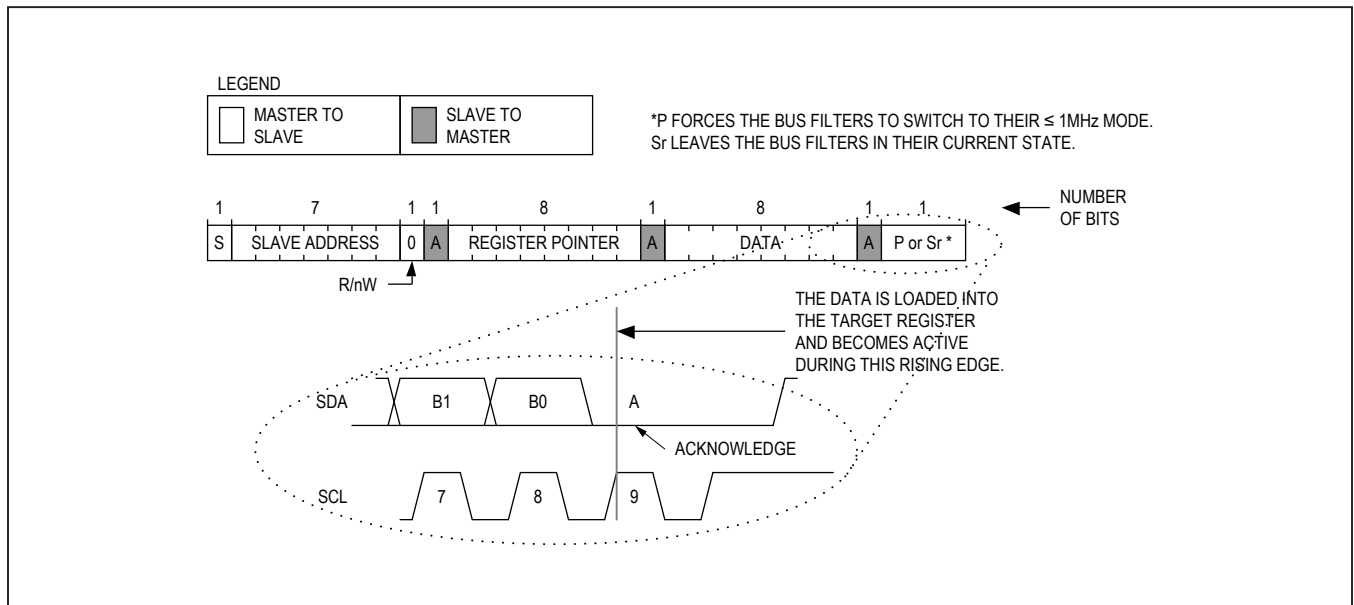

Figure 7. Writing to a Single Register with Write Byte Protocol

**Writing to Sequential Registers**

Figure 8 shows the protocol for writing to a sequential registers. This protocol is similar to the write byte protocol, except the master continues to write after it receives the first byte of data. When the master is done writing it issues a STOP or REPEATED START

The writing to sequential registers protocol is as follows:

- 1) The master sends a START command (S).
- 2) The master sends the 7-bit slave address followed by a write bit ( $R/\bar{W} = 0$ ).
- 3) The addressed slave asserts an ACKNOWLEDGE (A) by pulling SDA low.
- 4) The master sends an 8-bit register pointer.
- 5) The slave acknowledges the register pointer.
- 6) The master sends a data byte.
- 7) The slave acknowledges the data byte. At the rising edge of SCL, the data byte is loaded into its target register and the data becomes active.
- 8) Steps 6 to 7 are repeated as many times as the master requires.
- 9) During the last acknowledge related clock pulse, the master issues an ACKNOWLEDGE (A).
- 10) The master sends a STOP condition (P) or a REPEATED START condition (Sr). Issuing a P ensures that the bus input filters are set for 1MHz or slower operation. Issuing a REPEATED START (Sr) leaves the bus input filters in their current state.

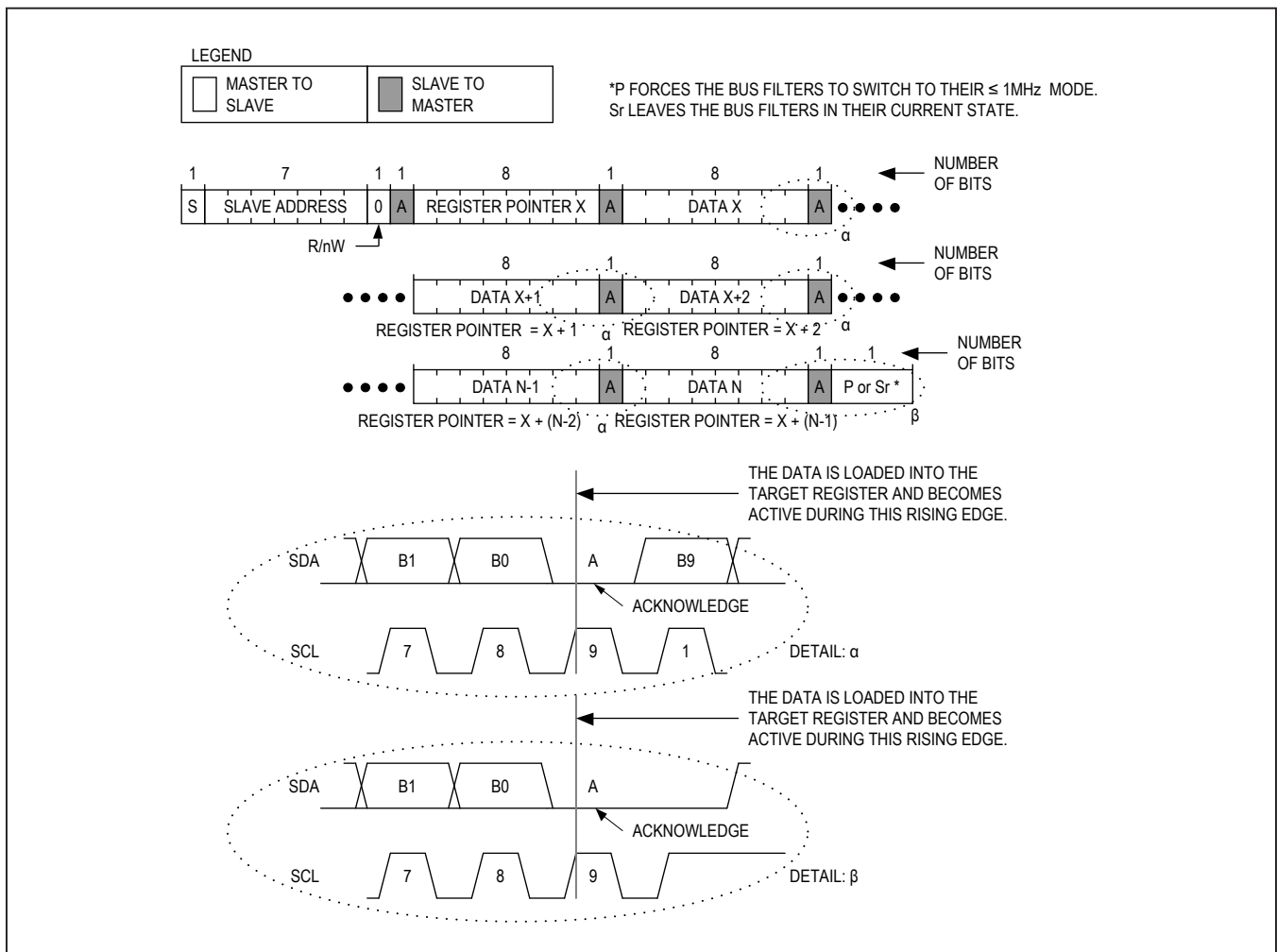

Figure 8. Writing to Sequential Registers "X" to "N"

**Writing Multiple Bytes using Register-Data Pairs**

Figure 9 shows the protocol for I<sup>2</sup>C master device to write multiple bytes to the MAX77812 using register-data pairs. This protocol allows I<sup>2</sup>C master device to address the slave only once and then send data to multiple registers in a random order. Registers may be written continuously until the master issues a STOP condition.

The “Multiple Byte Register-Data Pair” protocol is as follows:

- 1) The master sends a START command.
- 2) The master sends the 7-bit slave address followed by a write bit.
- 3) The addressed slave asserts an ACKNOWLEDGE (A) by pulling SDA LOW.
- 4) The master sends an 8-bit register pointer.
- 5) The slave acknowledges the register pointer.
- 6) The master sends a data byte.
- 7) The slave acknowledges the data byte. At the rising edge of SCL, the data byte is loaded into its target register and the data will become active.
- 8) Steps 4 to 7 are repeated as many times as the master requires.
- 9) The master sends a STOP condition.

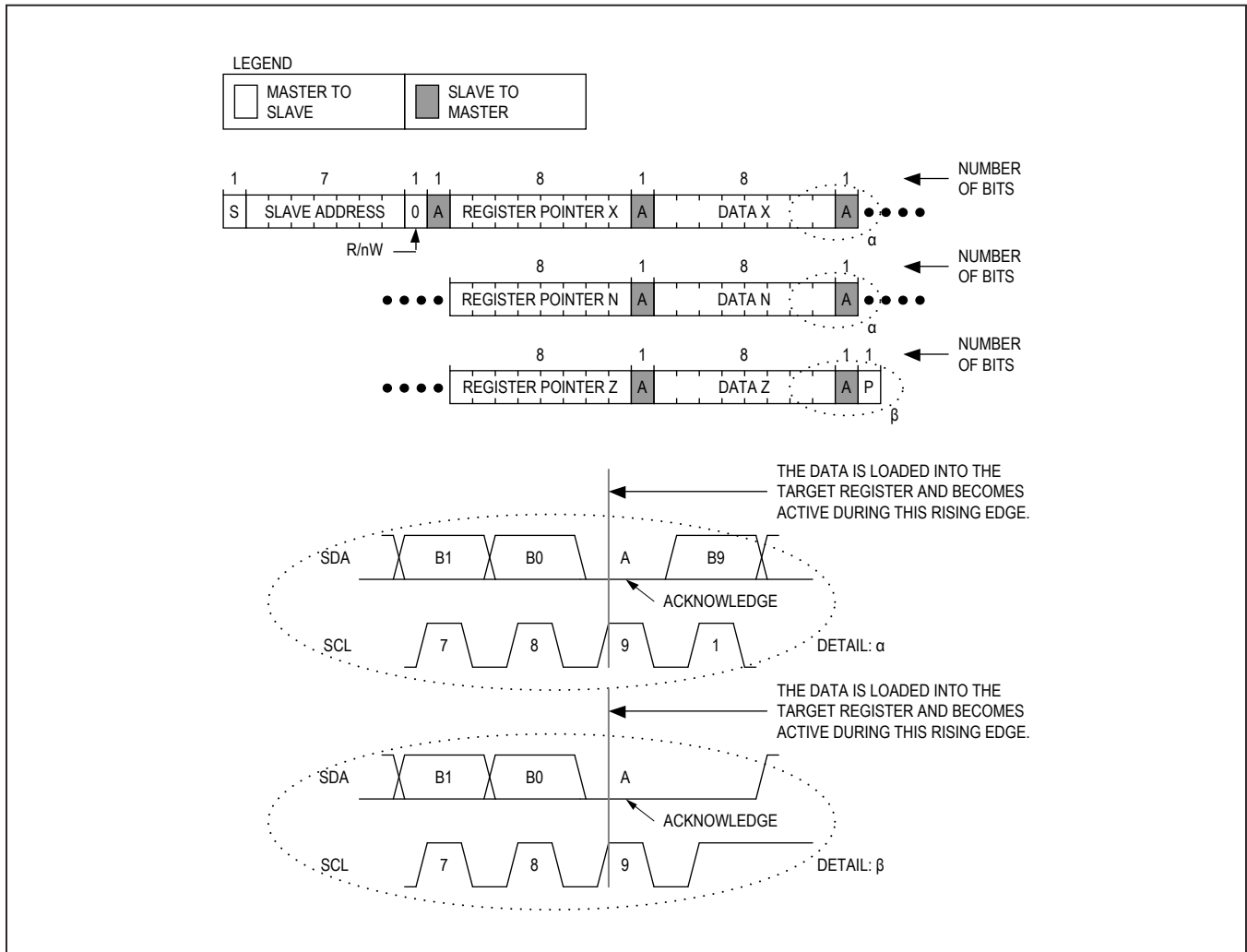

Figure 9. Writing to Multiple Registers with Multiple Byte Register Data Pairs Protocol

**Reading from a Single Register**

I<sup>2</sup>C master device reads one byte of data to the MAX77812. This protocol is the same as SMBus specification's read byte protocol.

The read byte protocol is as follows:

- 1) The master sends a START command (S).
- 2) The master sends the 7-bit slave address followed by a write bit ( $R/\overline{W} = 0$ ).
- 3) The addressed slave asserts an ACKNOWLEDGE (A) by pulling SDA low.
- 4) The master sends an 8-bit register pointer.
- 5) The slave acknowledges the register pointer.
- 6) The master sends a REPEATED START command (Sr).
- 7) The master sends the 7-bit slave address followed by a read bit ( $R/\overline{W} = 1$ ).
- 8) The addressed slave asserts an ACKNOWLEDGE (A) by pulling SDA low.
- 9) The addressed slave places 8-bits of data on the bus from the location specified by the register pointer.
- 10) The master issues a NOT ACKNOWLEDGE (nA).
- 11) The master sends a STOP condition (P) or a REPEATED START condition (Sr). Issuing a P ensures that the bus input filters are set for 1MHz or slower operation. Issuing a REPEATED START (Sr) leaves the bus input filters in their current state.

Note that every time the MAX77812 receives a STOP, its register pointer is set to 0x00. If reading register 0x00 after a STOP has been issued, steps 1 to 6 in the above algorithm can be skipped.

**Reading from Sequential Registers**

[Figure 10](#) shows the protocol for reading from sequential registers. This protocol is similar to the read byte protocol except the master issues an ACKNOWLEDGE (A) to sig-

nal the slave that it wants more data. When the master has all the data it requires, it issues a NOT ACKNOWLEDGE (nA) and a STOP (P) to end the transmission.

The continuous read from sequential registers protocol is as follows:

- 1) The master sends a START command (S).
- 2) The master sends the 7-bit slave address followed by a write bit ( $R/\overline{W} = 0$ ).
- 3) The addressed slave asserts an ACKNOWLEDGE (A) by pulling SDA low.
- 4) The master sends an 8-bit register pointer.
- 5) The slave acknowledges the register pointer.
- 6) The master sends a REPEATED START command (Sr).
- 7) The master sends the 7-bit slave address followed by a read bit ( $R/\overline{W} = 1$ ).
- 8) The addressed slave asserts an ACKNOWLEDGE (A) by pulling SDA low.
- 9) The addressed slave places 8 bits of data on the bus from the location specified by the register pointer.
- 10) The master issues an ACKNOWLEDGE (A) signaling the slave that it wishes to receive more data.
- 11) Steps 9 to 10 are repeated as many times as the master requires. Following the last byte of data, the master must issue a NOT ACKNOWLEDGE (nA) to signal that it wishes to stop receiving data.
- 12) The master sends a STOP condition (P) or a REPEATED START condition (Sr). Issuing a STOP (P) ensures that the bus input filters are set for 1MHz or slower operation. Issuing a REPEATED START (Sr) leaves the bus input filters in their current state.

Note that every time the MAX77812 receives a STOP its register pointer is set to 0x00. If reading register 0x00 after a STOP has been issued, steps 1 to 6 in the above algorithm can be skipped.

**Engaging HS Mode for Operation Up to 3.4MHz**

Figure 11 shows the protocol for engaging HS mode operation. HS mode operation allows for a bus operating speed up to 3.4MHz.

The engaging HS mode protocol is as follows:

- 1) Begin the protocol while operating at a bus speed of 1MHz or lower.
- 2) The master sends a START command (S).
- 3) The master sends the 8-bit master code of 00001xxx<sub>b</sub> where xxx<sub>b</sub> are don't care bits.
- 4) The addressed slave issues a NOT ACKNOWLEDGE (nA).
- 5) The master can now increase its bus speed up to 3.4MHz and issue any read/write operation.

The master can continue to issue high-speed read/write operations until a STOP (P) is issued. Issuing a STOP (P) ensures that the bus input filters are set for 1MHz or slower operation.

The MAX77812 I<sup>2</sup>C supports the HS mode extension feature. The HS extension feature keeps the high-speed operation even after STOP condition. This eliminates the needs of HS master code issued by the I<sup>2</sup>C master controller when the I<sup>2</sup>C master controller wants to stay in HS mode for multiple read/write cycles.

As shown in the state diagram, the HS extension mode can be enabled by setting HS\_EXT bit in I<sup>2</sup>C\_CFG register (ADDR 0x15) from LS mode only (entering HS extension mode from HS mode is not supported).

**SPI Slave Controller**

The serial interface includes a SPI slave controller and the selection between I<sup>2</sup>C and SPI slave controller is done by I<sup>2</sup>C\_SPI\_SEL input pin. The SPI slave controller requires a reset every time before the SPI master controller starts a new frame. This can be done by setting SCS (SPI chip select, active low) input high for more than 50ns. When SCS is held high, the MISO output is in a high-impedance state.

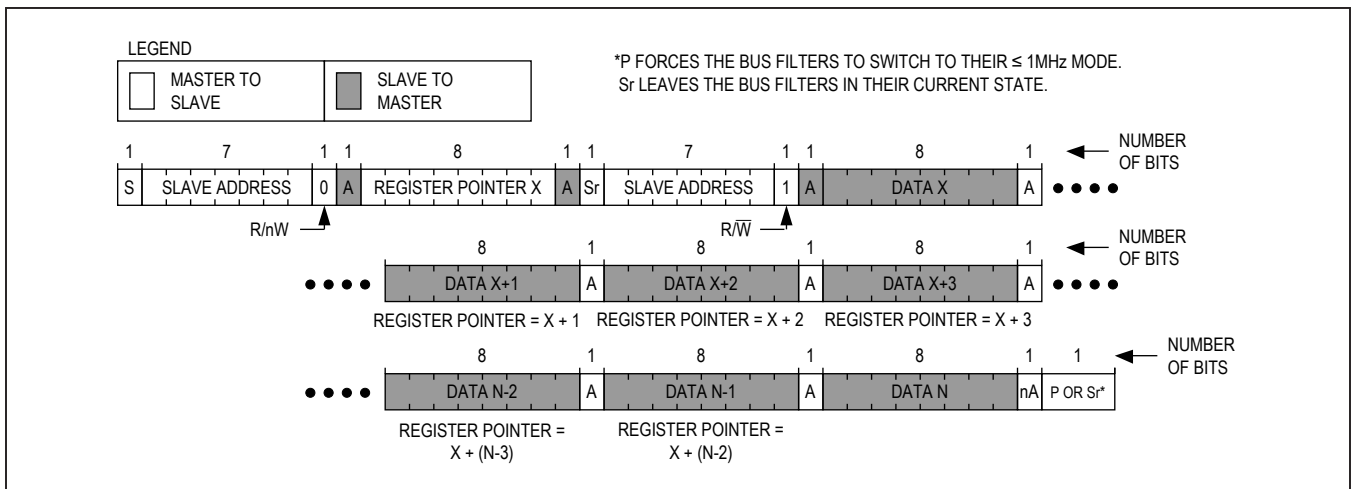

Figure 10. Reading Continuously from Sequential Registers "X" to "N"

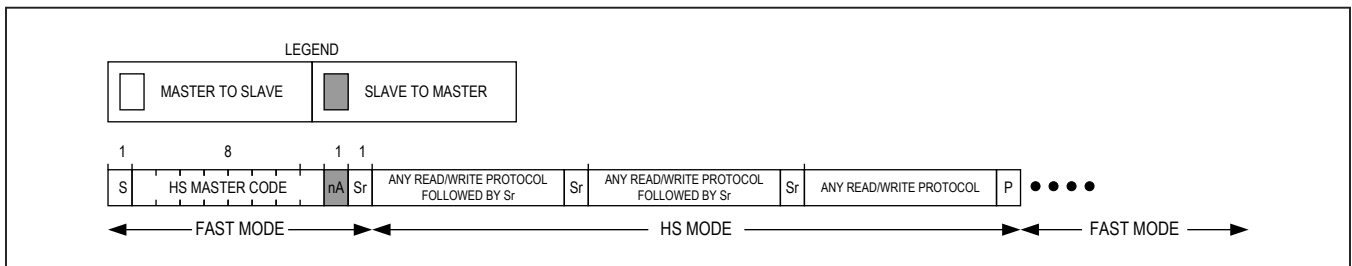

Figure 11. Engaging HS Mode



**Features**

The SPI slave controller has following features:

- Slave Only
- Single Read/Write Support
- Multiple Read/Write Support
- Up to 30MHz (26MHz typ)

**General Description**

The SPI slave controller works with CKPOL = 0, CKPHA = 0 setting in the SPI master controller. In other words, idle state of SCL is low and the SPI controller samples data in the rising edge of SCL. Besides single read/write cycle, the SPI slave controller also supports multiple read/write cycles.

Figure 13, Figure 14, and Figure 15 show single and multiple read/write frame structures.

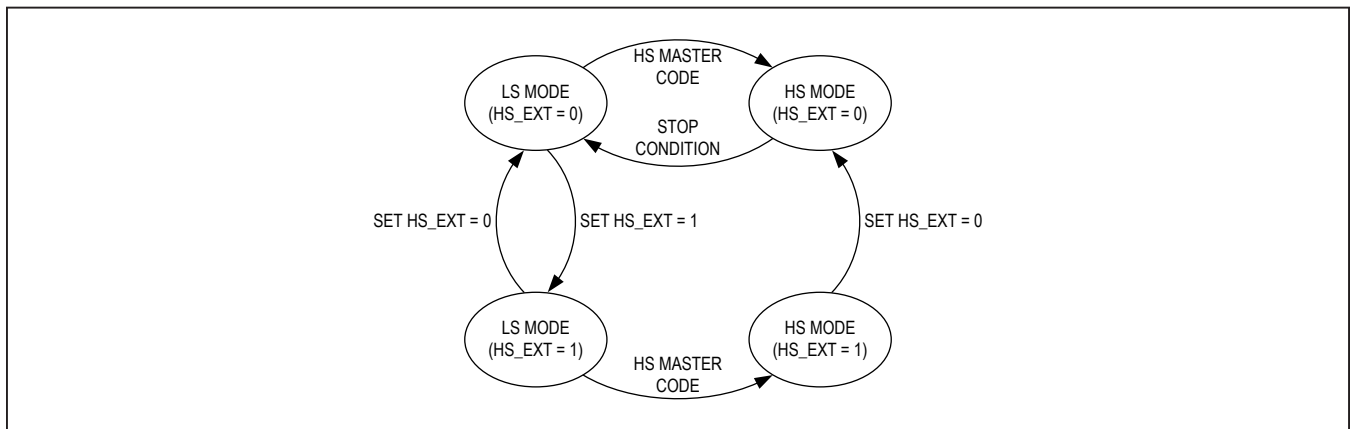

Figure 12. I<sup>2</sup>C Operating Mode State Diagram

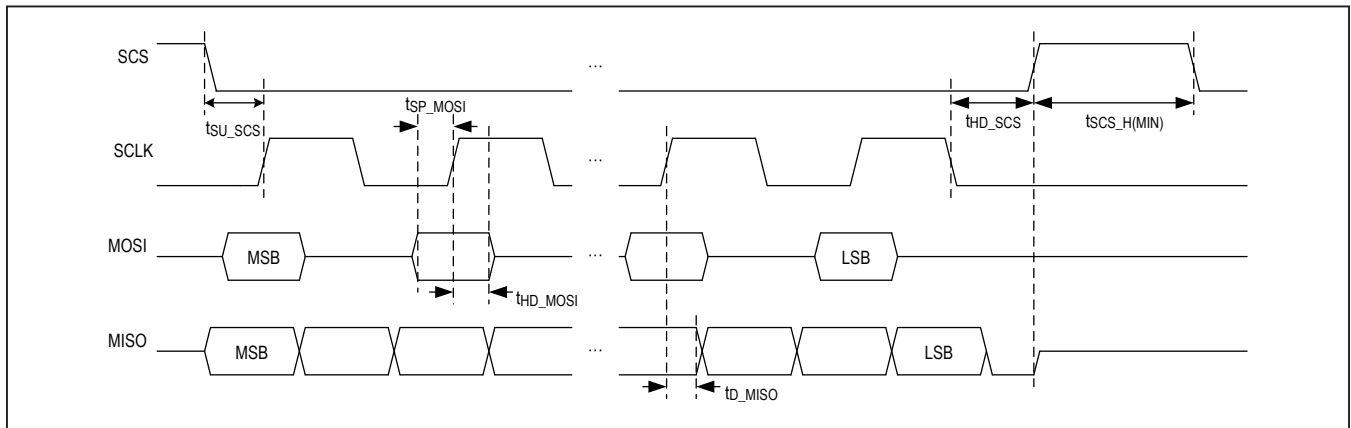

Figure 13. SPI Timing Diagram

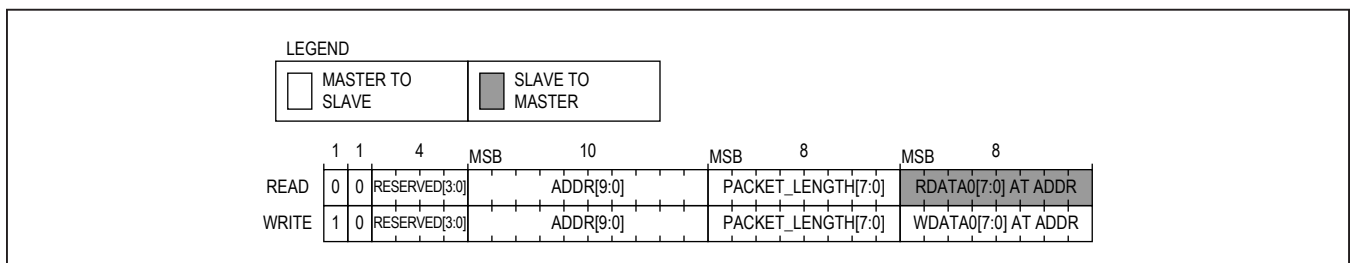

Figure 14. SPI Single Read/Write Frame Structure

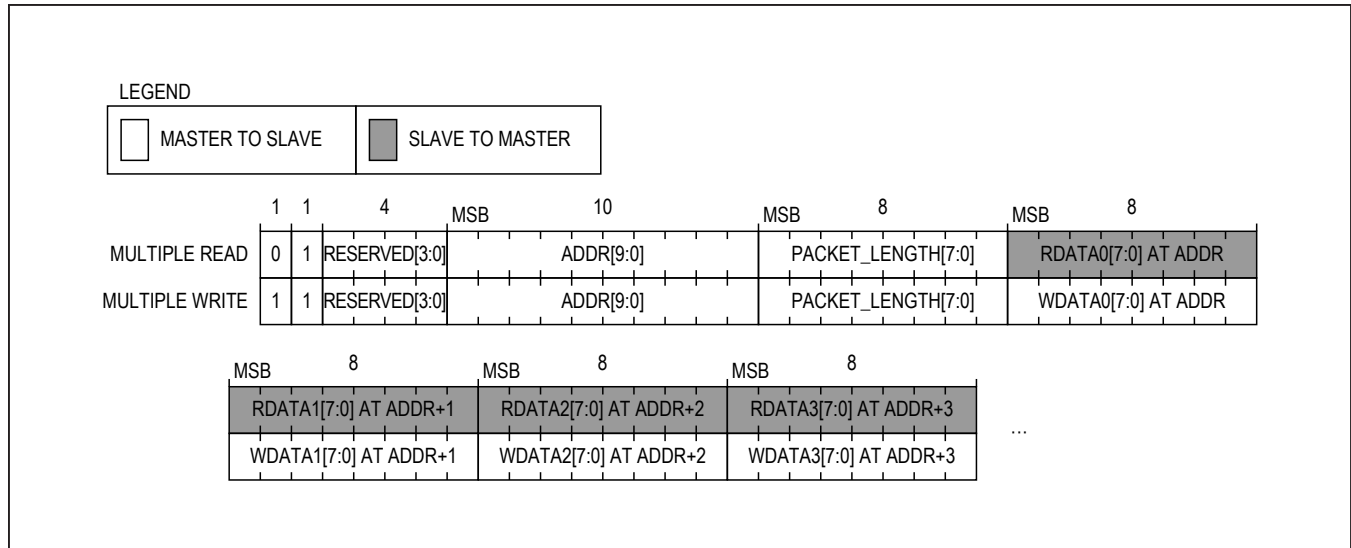

Figure 15. SPI Multiple Read/Write Frame Structure

**Frame Structure**

**Read/Write Bit (R/W)**

The first bit indicates either read (0) or write (1) frame.

**Single/Multiple Bit (S/M)**

The second bit determines either single read/write frame (0) or multiple read/write frame (1).

**Reserved Bits (RESERVED[3:0])**

There are 4 reserved bits followed by read/write and single/multiple bits. The MAX77812 SPI slave controller ignores those bits.

**Address Bits (ADDR[9:0])**

The SPI master controller loads 10 address bits on MOSI, however, the MAX77812 has only 8-bit address bus so that the SPI slave controller ignores attempt to access to overflowed addresses (beyond 0xFF).

**Packet Length Bits (PACKET\_LENGTH[7:0])**

The length of single read/write frame is organized as 32-bit (packet length bits are ignored).

For multiple read/write frame, PACKET\_LENGTH[7:0] bits determine the number of data bytes. The total length of the multiple read/write frame is '32 + 8 x n' bits, where 'n' is the packet length.

**Data Bits (RDATA[7:0]/WDATA[7:0])**

The SPI slave controller has 8-bit data bus. While the slave controller is loading data onto MISO, it ignores the data on MOSI. When MISO is inactive, it is held low by the SPI slave controller.

**Multiple Write Cycles**

Figure 16 is the timing diagram of multiple write cycle. The first data (WDATA0[7:0]) is written at ADDR[9:0] if the address is valid. For the next data byte, the register address automatically increases by one. The total number of data bytes are determined by PACKET\_LENGTH[7:0] and the MAX77812 slave controller ignores the any data bytes beyond the total number of data bytes (PACKET\_LENGTH[7:0] + 1). While the SPI master controller is writing data onto MOSI, the SPI controller keeps MISO to a low state.

**Multiple Read Cycles**

The timing diagram of multiple read cycle is shown in [Figure 17](#). The first data (RDATA0[7:0]) is read at ADDR[9:0] if the address is valid. For the next data byte, the register address automatically increases by one. The total number of data bytes are determined by PACKET\_LENGTH[7:0] and the MAX77812 slave controller stops loading data beyond the total number of data

bytes (PACKET\_LENGTH[7:0] + 1). While the SPI master controller is writing data onto MOSI, the MAX77812 SPI controller keeps MISO to a low state. When the SPI slave controller loads the data on MISO, the data on MOSI are ignored (don't care) by the SPI slave controller.

In case the SPI master controller tries to read nonexisting registers, the MAX77812 SPI slave controller returns zero values (MISO = low).

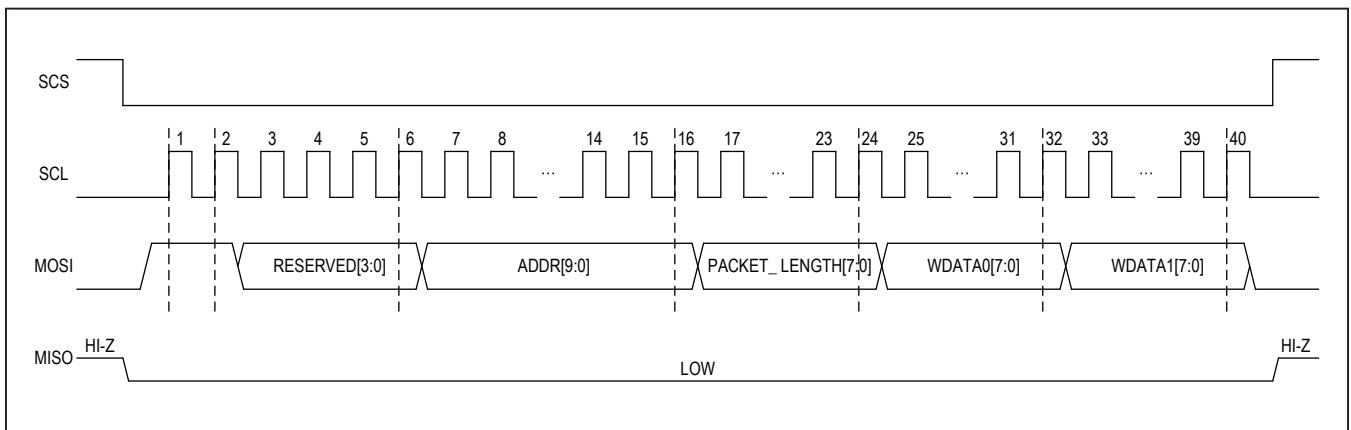

Figure 16. SPI Multiple Write Cycle

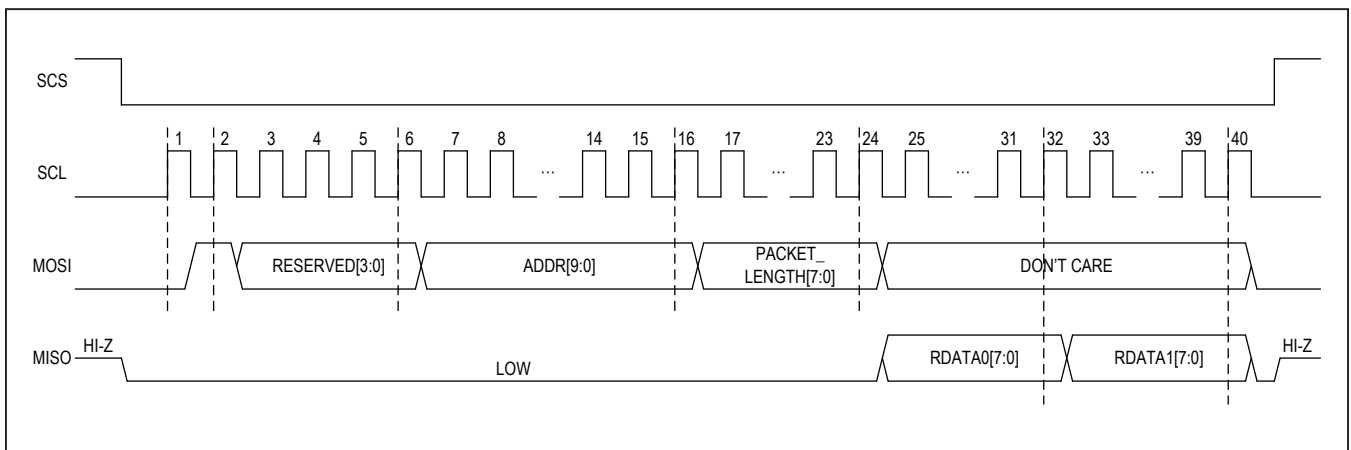

Figure 17. SPI Multiple Read Cycle

**PMIC Registers**

**Register Reset Conditions**

Type-S1: Registers are reset when  $V_{SYS} < POR$  ( $\approx 1.50V$ )

Type-O: Registers are reset when  $V_{SYS} < V_{UVLO\_F}$  or  $V_{VIO} < V_{TH\_VIO\_OK}$  or  $CE = low$  or  $TOK = low$  or  $SW\_RST = 1$ .

**Register Map**

ADDR	REGISTER NAME	RESET TYPE	R/W	BIT7	BIT6	BIT5	BIT4	BIT3	BIT2	BIT1	BIT0	RESET VALUE	
0x00	REG_RESET	Type-O	W/C	RESERVED	RESERVED	RESERVED	RESERVED	RESERVED	RESERVED	RESERVED	SW_RST	0x00	
0x01	INT_SRC	Type-O	R	RESERVED	RESERVED	RESERVED	RESERVED	RESERVED	RESERVED	BUCK_INT	TOPSYS_INT	0x00	
0x02	INT_SRC_M	Type-O	R/W	RESERVED	RESERVED	RESERVED	RESERVED	RESERVED	RESERVED	BUCK_INT_M	TOPSYS_INT_M	0x02	
0x03	TOPSYS_INT	Type-S1	R/C	RESERVED	RESERVED	RESERVED	WDTRSTB_INT	UVLO_INT	TSHDN_INT	TJCT_140C_INT	TJCT_120C_INT	0x00	
0x04	TOPSYS_INT_M	Type-O	R/W	RESERVED	RESERVED	RESERVED	WDTRSTB_M	UVLO_M	TSHDN_M	TJCT_140C_M	TJCT_120C_M	0x13	
0x05	TOPSYS_STAT	Type-O	R	RESERVED	RESERVED	RESERVED	RESERVED	UVLO	TSHDN	TJCT_140C	TJCT_120C	—	
0x06	EN_CTRL	Type-O	R/W	EN_M4_LPM	EN_M4	EN_M3_LPM	EN_M3	EN_M2_LPM	EN_M2	EN_M1_LPM	EN_M1	0x00	
0x07	STUP_DLY1	Type-O	R/W	DLY_STEP	RESERVED	RESERVED	RESERVED	M2_STUP_DLY[4:0]	M2_STUP_DLY[4:0]			0x00	
0x08	STUP_DLY2	Type-O	R/W	RESERVED	RESERVED	RESERVED	RESERVED	M3_STUP_DLY[4:0]	M3_STUP_DLY[4:0]			0x00	
0x09	STUP_DLY3	Type-O	R/W	RESERVED	RESERVED	RESERVED	RESERVED	M4_STUP_DLY[4:0]	M4_STUP_DLY[4:0]			0x00	
0x0A	SHDN_DLY1	Type-O	R/W	RESERVED	RESERVED	RESERVED	RESERVED	M1_SHDN_DLY[4:0]	M1_SHDN_DLY[4:0]			0x00	
0x0B	SHDN_DLY2	Type-O	R/W	RESERVED	RESERVED	RESERVED	RESERVED	M2_SHDN_DLY[4:0]	M2_SHDN_DLY[4:0]			0x00	
0x0C	SHDN_DLY3	Type-O	R/W	RESERVED	RESERVED	RESERVED	RESERVED	M3_SHDN_DLY[4:0]	M3_SHDN_DLY[4:0]			0x00	
0x0D	SHDN_DLY4	Type-O	R/W	RESERVED	RESERVED	RESERVED	RESERVED	M4_SHDN_DLY[4:0]	M4_SHDN_DLY[4:0]			0x00	
0x0E	WDTRSTB_DEB	Type-O	R/W	RESERVED	RESERVED	RESERVED	RESERVED	RESERVED	RESERVED	WDT_DEB[2:0]		0x02	
0x0F	GPI_FUNC	Type-O	R/W	GPI1_FUNC[3:0]			GPI1_FUNC[3:0]			GPI0_FUNC[3:0]			0x43
0x10	GPI_DEB1	Type-O	R/W	LPM_DEB[2:0]			LPM_DEB[2:0]			EN_DEB[2:0]			0x11
0x11	GPI_DEB2	Type-O	R/W	GPI1_DEB[2:0]			GPI1_DEB[2:0]			GPI0_DEB[2:0]			0x11
0x12	GPI_PD_CTRL	Type-O	R/W	RESERVED	RESERVED	RESERVED	RESERVED	LPM_PD	EN_PD	GPI1_PD	GPI0_PD	0x0F	
0x13	PROT_CFG	Type-O	R/W	TSHDN_EN	RESERVED	RESERVED	RESERVED	RESERVED	RESERVED	UVLO_F[2:0]		0x82	
0x15	I2C_CFG	Type-O	R/W	RESERVED	RESERVED	RESERVED	RESERVED	RESERVED	RESERVED	PAIR	HS_EXT	0x00	
0x16 – 0x1F	RESERVED												

Register Map (continued)

ADDR	REGISTER NAME	RESET TYPE	R/W	BIT7	BIT6	BIT5	BIT4	BIT3	BIT2	BIT1	BIT0	RESET VALUE
0x20	BUCK_INT	Type-S1	R/C	RESERVED	RESERVED	RESERVED	RESERVED	M4_POKn_INT	M3_POKn_INT	M2_POKn_INT	M1_POKn_INT	0x00
0x21	BUCK_INT_M	Type-O	R/W	RESERVED	RESERVED	RESERVED	RESERVED	M4_POKn_M	M3_POKn_M	M2_POKn_M	M1_POKn_M	0x0F
0x22	BUCK_STAT	Type-O	R	RESERVED	RESERVED	RESERVED	RESERVED	M4_POKn	M3_POKn	M2_POKn	M1_POKn	-
0x23	M1_VOUT	Type-O	R/W	M1_VOUT[7:0]								0x50
0x24	M2_VOUT	Type-O	R/W	M2_VOUT[7:0]								0x50
0x25	M3_VOUT	Type-O	R/W	M3_VOUT[7:0]								0x46
0x26	M4_VOUT	Type-O	R/W	M4_VOUT[7:0]								0x46
0x27	M1_VOUT_D	Type-O	R/W	M1_VOUT_D[7:0]								0x78
0x28	M2_VOUT_D	Type-O	R/W	M2_VOUT_D[7:0]								0x78
0x29	M3_VOUT_D	Type-O	R/W	M3_VOUT_D[7:0]								0x78
0x2A	M4_VOUT_D	Type-O	R/W	M4_VOUT_D[7:0]								0x78
0x2B	M1_VOUT_S	Type-O	R/W	M1_VOUT_S[7:0]								0x1E
0x2C	M2_VOUT_S	Type-O	R/W	M2_VOUT_S[7:0]								0x1E
0x2D	M3_VOUT_S	Type-O	R/W	M3_VOUT_S[7:0]								0x1E
0x2E	M4_VOUT_S	Type-O	R/W	M4_VOUT_S[7:0]								0x1E
0x2F	M1_CGF	Type-O	R/W	M1_AD	M1_ILIM[2:0]		RESERVED	RESERVED	RESERVED	M1_FPWM	M1_FSREN	0xD1
0x30	M2_CGF	Type-O	R/W	M2_AD	M2_ILIM[2:0]		RESERVED	RESERVED	RESERVED	M2_FPWM	M2_FSREN	0xD1
0x31	M3_CGF	Type-O	R/W	M3_AD	M3_ILIM[2:0]		RESERVED	RESERVED	RESERVED	M3_FPWM	M3_FSREN	0xD1
0x32	M4_CGF	Type-O	R/W	M4_AD	M4_ILIM[2:0]		RESERVED	RESERVED	RESERVED	M4_FPWM	M4_FSREN	0xD1
0x33	GLB_CFG1	Type-O	R/W	RESERVED	B_SD_SR[2:0]		RESERVED	RESERVED	B_SS_SR[2:0]		0x24	
0x34	GLB_CFG2	Type-O	R/W	RESERVED	B_RD_SR[2:0]		RESERVED	RESERVED	B_RU_SR[2:0]		0x24	
0x35	GLB_CFG3	Type-O	R/W	RESERVED	RESERVED	RESERVED	RESERVED	RESERVED	RESERVED	B_PETR_EN	B_NETR_EN	0x5F
0x36 - 0xFF	RESERVED											

\*R/W: Read and write

R: Read only

R/C: Read and clear

W/C: Write and clear

**REG\_RESET Register Reset Control Register**

ADDRESS	MODE		TYPE: O	RESET VALUE: 0x00
0x00	W/C			
BIT	NAME	POR	DESCRIPTION	
7:1	RESERVED	0000 000		
0	SW_RST	0	Type-O Register Reset Control 1: Reset all Type-O registers to their POR default values. This bit clears to '0' upon reset.	

**INT\_SRC Interrupt Source Register**

ADDRESS	MODE		TYPE: O	RESET VALUE: 0x00
0x01	R			
BIT	NAME	POR	DESCRIPTION	
7:2	RESERVED	0000 00		
1	BUCK_INT	0	1: Interrupt event on BUCK is detected	
0	TOPSYS_INT	0	1: Interrupt event on TOPSYS is detected	

**INT\_SRC\_M Interrupt Source Mask Register**

ADDRESS	MODE		TYPE: O	RESET VALUE: 0x02
0x02	R/W			
BIT	NAME	POR	DESCRIPTION	
7:4	RESERVED	0000 00		
1	BUCK_INT_M	1	0: Enable BUCK_INT 1: Mask BUCK_INT	
0	TOPSYS_INT_M	0	0: Enable TOPSYS_INT 1: Mask TOPSYS_INT	

**TOPSYS\_INT TOPSYS Interrupt Register**

ADDRESS	MODE		TYPE: S1	RESET VALUE: 0x00
0x03	R/C			
BIT	NAME	POR	DESCRIPTION	
7:5	RESERVED	000		
4	WDTRSTB_INT	0	1: WDTRSTB interrupt has triggered.	
3	UVLO_INT	0	1: UVLO interrupt has triggered.	
2	TSHDN_INT	0	1: TSHDN interrupt has triggered.	
1	TJCT_140C_INT	0	1: TJCT_140C interrupt has triggered.	
0	TJCT_120C_INT	0	1: TJCT_120C interrupt has triggered.	

**TOPSYS\_INT\_M TOPSYS Interrupt Mask Register**

ADDRESS	MODE		TYPE: O	RESET VALUE: 0x13
0x04	R/W			
BIT	NAME	POR	DESCRIPTION	
7:5	RESERVED	000		
4	WDTRSTB_M	1	0: Enable WDTRSTB_INT. 1: Mask WDTRSTB_INT.	
3	UVLO_M	0	0: Enable UVLO_INT. 1: Mask UVLO_INT.	
2	TSHDN_M	0	0: Enable TSHDN_INT. 1: Mask TSHDN_INT.	
1	TJCT_140C_M	1	0: Enable TJCT_140C_INT. 1: Mask TJCT_140C_INT.	
0	TJCT_120C_M	1	0: Enable TJCT_120C_INT. 1: Mask TJCT_120C_INT.	

**TOPSYS\_STAT TOPSYS Status Register**

ADDRESS	MODE		TYPE: O	RESET VALUE: N/A
0x05	R			
BIT	NAME	POR	DESCRIPTION	
7:4	RESERVED	—		
3	UVLO	—	0: $V_{SYS} \geq V_{UVLO\_F}$ 1: $V_{SYS} < V_{UVLO\_F}$	
2	TSHDN	—	0: Junction Temperature ( $T_{JCT}$ ) $\leq +165^{\circ}\text{C}$ 1: Junction Temperature ( $T_{JCT}$ ) $> +165^{\circ}\text{C}$	
1	TJCT_140C	—	0: Junction Temperature ( $T_{JCT}$ ) $\leq +140^{\circ}\text{C}$ 1: Junction Temperature ( $T_{JCT}$ ) $> +140^{\circ}\text{C}$	
0	TJCT_120C	—	0: Junction Temperature ( $T_{JCT}$ ) $\leq +120^{\circ}\text{C}$ 1: Junction Temperature ( $T_{JCT}$ ) $> +120^{\circ}\text{C}$	

**EN\_CTRL Regulator Enable Control Register**

ADDRESS	MODE		TYPE: O	RESET VALUE: 0x00
0x06	R/W			
BIT	NAME	POR	DESCRIPTION	
7	EN_M4_LPM	0	0: Disable BUCK Master 4 low power mode. 1: Enable BUCK Master 4 low power mode.	
6	EN_M4	0	0: Disable BUCK Master 4 output. 1: Enable BUCK Master 4 output ('OR' logic with GP1x input).	
5	EN_M3_LPM	0	0: Disable BUCK Master 3 low power mode. 1: Enable BUCK Master 3 low power mode.	
4	EN_M3	0	0: Disable BUCK Master 3 output. 1: Enable BUCK Master 3 output ('OR' logic with GP1x input).	
3	EN_M2_LPM	0	0: Disable BUCK Master 2 low power mode. 1: Enable BUCK Master 2 low power mode.	
2	EN_M2	0	0: Disable BUCK Master 2 output. 1: Enable BUCK Master 2 output ('OR' logic with GP1x input).	
1	EN_M1_LPM	0	0: Disable BUCK Master 1 low power mode. 1: Enable BUCK Master 1 low power mode.	
0	EN_M1	0	0: Disable BUCK Master 1 output. 1: Enable BUCK Master 1 output ('OR' logic with GP1x input).	

**STUP\_DLY1 Global Startup Delay Setting Register 1**

ADDRESS	MODE		TYPE: O (OTP)	RESET VALUE: 0x00
0x07	R/W			
BIT	NAME	POR	DESCRIPTION	
7	DLY_STEP	0	Delay Time Step Selection 0: 1ms 1: 2ms	
6:5	RESERVED	00		
4:0	M2_STUP_DLY[4:0]	0 0000	BUCK Master 2 Startup Delay Time Setting (Delay from Rising Edge of EN Pin or GLB_EN) 0 0000b = 0ms 0 0001b = 1 x DLY_STEP 0 0010b = 2 x DLY_STEP . . . 1 1110b = 30 x DLY_STEP 1 1111b = 31 x DLY_STEP	



**STUP\_DLY2 Global Startup Delay Setting Register 2**

ADDRESS	MODE		TYPE: O (OTP)	RESET VALUE: 0x00
0x08	R/W			
BIT	NAME	POR	DESCRIPTION	
7:5	RESERVED	000		
4:0	M3_STUP_DLY[4:0]	0 0000	BUCK Master 3 Startup Delay Time Setting (Delay from Rising Edge of EN Pin or GLB_EN) 0 0000b = 0ms 0 0001b = 1 x DLY_STEP 0 0010b = 2 x DLY_STEP . . . . . . 1 1110b = 30 x DLY_STEP 1 1111b = 31 x DLY_STEP	

**STUP\_DLY3 Global Startup Delay Setting Register 3**

ADDRESS	MODE		TYPE: O (OTP)	RESET VALUE: 0x00
0x09	R/W			
BIT	NAME	POR	DESCRIPTION	
7:5	RESERVED	000		
4:0	M4_STUP_DLY[4:0]	0 0000	BUCK Master 4 Startup Delay Time Setting (Delay from Rising Edge of EN Pin or GLB_EN) 0 0000b = 0ms 0 0001b = 1 x DLY_STEP 0 0010b = 2 x DLY_STEP . . . . . . 1 1110b = 30 x DLY_STEP 1 1111b = 31 x DLY_STEP	

**SHDN\_DLY1 Global Shutdown Delay Setting Register 1**

ADDRESS	MODE		TYPE: O	RESET VALUE: 0x00
0x0A	R/W			
BIT	NAME	POR	DESCRIPTION	
7:5	RESERVED	000		
4:0	M1_SHDN_DLY[4:0]	0 0000	BUCK Master 1 Shutdown Delay Time Setting (Delay from Falling Edge of EN Pin or GLB_EN) 0 0000b = 0ms 0 0001b = 1 x DLY_STEP 0 0010b = 2 x DLY_STEP . . . . . . 1 1110b = 30 x DLY_STEP 1 1111b = 31 x DLY_STEP	

**SHDN\_DLY2 Global Shutdown Delay Setting Register 2**

ADDRESS	MODE		TYPE: 0	RESET VALUE: 0x00
0x0B	R/W			
BIT	NAME	POR	DESCRIPTION	
7:5	RESERVED	000		
4:0	M2_SHDN_DLY[4:0]	0 0000	BUCK Master 2 Shutdown Delay Time Setting (Delay from Falling Edge of EN Pin or GLB_EN) 0 0000b = 0ms 0 0001b = 1 x DLY_STEP 0 0010b = 2 x DLY_STEP . . . 1 1110b = 30 x DLY_STEP 1 1111b = 31 x DLY_STEP	

**SHDN\_DLY3 Global Shutdown Delay Setting Register 3**

ADDRESS	MODE		TYPE: 0	RESET VALUE: 0x00
0x0C	R/W			
BIT	NAME	POR	DESCRIPTION	
7:5	RESERVED	000		
4:0	M3_SHDN_DLY[4:0]	0 0000	BUCK Master 3 Shutdown Delay Time Setting (Delay from Falling Edge of EN Pin or GLB_EN) 0 0000b = 0ms 0 0001b = 1 x DLY_STEP 0 0010b = 2 x DLY_STEP . . . 1 1110b = 30 x DLY_STEP 1 1111b = 31 x DLY_STEP	

**SHDN\_DLY4 Global Shutdown Delay Setting Register 4**

ADDRESS	MODE		TYPE: 0	RESET VALUE: 0x00
0x0D	R/W			
BIT	NAME	POR	DESCRIPTION	
7:5	RESERVED	000		
4:0	M4_SHDN_DLY[4:0]	0 0000	BUCK Master 4 Shutdown Delay Time Setting (Delay from Falling Edge of EN Pin or GLB_EN) 0 0000b = 0ms 0 0001b = 1 x DLY_STEP 0 0010b = 2 x DLY_STEP . . . 1 1110b = 30 x DLY_STEP 1 1111b = 31 x DLY_STEP	

**WDTRSTB\_DEB WDTRSTB\_IN Input Debounce Time Setting Register**

ADDRESS	MODE		TYPE: O	RESET VALUE: 0x02
0x0E	R/W			
BIT	NAME	POR	DESCRIPTION	
7:3	RESERVED	0000 0		
2:0	WDT_DEB[2:0]	010	WDTRSTB_IN Debounce Time Setting 000b = 0ms 001b = 0.8ms 010b = 1.6ms 011b = 3.2ms 100b = 6.4ms 101b = 12.8ms 111b = 51.2ms	

**GPI\_FUNC GPI Function Selection Register**

ADDRESS	MODE		TYPE: O	RESET VALUE: 0x43
0x0F	R/W			
BIT	NAME	POR	DESCRIPTION	
7:4	GPI1_FUNC[3:0]	0100	GPI1 Function Selection 0000b: GLB_EN    1000b: M3_VSEL 0001b: M1_EN    1001b: M4_VSEL 0010b: M2_EN    1010b: GLB_LPM 0011b: M3_EN    1011b: M1_LPM 0100b: M4_EN    1100b: M2_LPM 0101b: GLB_VSEL 1101b: M3_LPM 0110b: M1_VSEL 1110b: M4_LPM 0111b: M2_VSEL 1111b: No Function	
3:0	GPI0_FUNC[3:0]	0011	GPIO Function Selection 0000b: GLB_EN    1000b: M3_VSEL 0001b: M1_EN    1001b: M4_VSEL 0010b: M2_EN    1010b: GLB_LPM 0011b: M3_EN    1011b: M1_LPM 0100b: M4_EN    1100b: M2_LPM 0101b: GLB_VSEL 1101b: M3_LPM 0110b: M1_VSEL 1110b: M4_LPM 0111b: M2_VSEL 1111b: No Function	

**GPI\_DEB1 GPI Debounce Time Setting Register 1**

ADDRESS	MODE		TYPE: O	RESET VALUE: 0x11
0x10	R/W			
BIT	NAME	POR	DESCRIPTION	
7:4	LPM_DEB[3:0]	0001	LPM Debounce Time Setting 0000b = 0µs      1000b = 512µs 0001b = 64µs     1001b = 576µs 0010b = 128µs    1010b = 640µs 0011b = 192µs    1011b = 704µs 0100b = 256µs    1100b = 768µs 0101b = 320µs    1101b = 832µs 0110b = 384µs    1110b = 896µs 0111b = 448µs    1111b = 960µs	
3:0	EN_DEB[3:0]	0001	EN Debounce Time Setting 0000b = 0µs      1000b = 512µs 0001b = 64µs     1001b = 576µs 0010b = 128µs    1010b = 640µs 0011b = 192µs    1011b = 704µs 0100b = 256µs    1100b = 768µs 0101b = 320µs    1101b = 832µs 0110b = 384µs    1110b = 896µs 0111b = 448µs    1111b = 960µs	

**GPI\_DEB2 GPI Debounce Time Setting Register 2**

ADDRESS	MODE		TYPE: O	RESET VALUE: 0x11
0x11	R/W			
BIT	NAME	POR	DESCRIPTION	
7:4	GPI1_DEB[3:0]	0001	GPI1 Debounce Time Setting 0000b = 0µs      1000b = 512µs 0001b = 64µs     1001b = 576µs 0010b = 128µs    1010b = 640µs 0011b = 192µs    1011b = 704µs 0100b = 256µs    1100b = 768µs 0101b = 320µs    1101b = 832µs 0110b = 384µs    1110b = 896µs 0111b = 448µs    1111b = 960µs	
3:0	GPI0_DEB[3:0]	0001	GPI0 Debounce Time Setting 0000b = 0µs      1000b = 512µs 0001b = 64µs     1001b = 576µs 0010b = 128µs    1010b = 640µs 0011b = 192µs    1011b = 704µs 0100b = 256µs    1100b = 768µs 0101b = 320µs    1101b = 832µs 0110b = 384µs    1110b = 896µs 0111b = 448µs    1111b = 960µs	

**GPI\_PD\_CTRL GPI Pulldown Resistor Control Register**

ADDRESS	MODE		TYPE: O	RESET VALUE: 0x0F
0x12	R/W			
BIT	NAME	POR	DESCRIPTION	
7:4	RESERVED	0000		
3	LPM_PD	1	LPM Input Pulldown Resistor Enable Setting 0: Disable 1: Enable	
2	EN_PD	1	EN Input Pulldown Resistor Enable Setting 0: Disable 1: Enable	
1	GPI1_PD	1	GPI1 Input Pulldown Resistor Enable Setting 0: Disable 1: Enable	
0	GPI0_PD	1	GPI0 Input Pulldown Resistor Enable Setting 0: Disable 1: Enable	

**PROT\_CFG Protection Configuration Register**

ADDRESS	MODE		TYPE: O	RESET VALUE: 0x82
0x13	R/W			
BIT	NAME	POR	DESCRIPTION	
7	TSHDN_EN	1	Thermal Protection Enable Control 0: Disable (TSHDN_INT is not disabled) 1: Enable	
6:3	RESERVED	000 0		
2:0	UVLO_F[2:0]	010	V <sub>SYS</sub> UVLO Falling Threshold 000b = 1.95V 001b = 2.05V 010b = 2.15V 011b = 2.25V 100b = 2.35V 101b = 2.45V 110b = 2.55V 111b = Disabled	

0x14: RESERVED

**I2C\_CFG I2C Configuration Register**

ADDRESS	MODE		TYPE: O	RESET VALUE: 0x00
0x15	R/W			
BIT	NAME	POR	DESCRIPTION	
7:4	RESERVED	NA		
3:2	RESERVED	00	Write '00'	
1	PAIR	0	Register Data Pair Mode 0: Disable (Sequential Mode) 1: Enable	
0	HS_EXT	0	HS Mode Extension 0: Disable HS mode extension (I2C Rev. 4 Compliant). 1: Enable HS mode extension. (HS mode is extended during/after 'STOP' condition.)	

0x16 – 0x1F: RESERVED

**BUCK\_INT Regulators Interrupt Register**

ADDRESS	MODE		TYPE: S1	RESET VALUE: 0x00
0x20	R/C			
BIT	NAME	POR	DESCRIPTION	
7:4	RESERVED	0000		
3	M4_POK_INT	0	1: BUCK Master 4 POK interrupt has triggered.	
2	M3_POK_INT	0	1: BUCK Master 3 POK interrupt has triggered.	
1	M2_POK_INT	0	1: BUCK Master 2 POK interrupt has triggered.	
0	M1_POK_INT	0	1: BUCK Master 1 POK interrupt has triggered.	

**BUCK\_INT\_M BUCK Interrupt Mask Register**

ADDRESS	MODE		TYPE: O	RESET VALUE: 0x0F
0x21	R/W			
BIT	NAME	POR	DESCRIPTION	
7:4	RESERVED	0000		
3	M4_POK_M	1	0: Enable M4_POK_INT. 1: Mask M4_POK_INT.	
2	M3_POK_M	1	0: Enable M3_POK_INT. 1: Mask M3_POK_INT.	
1	M2_POK_M	1	0: Enable M2_POK_INT. 1: Mask M2_POK_INT.	
0	M1_POK_M	1	0: Enable M1_POK_INT. 1: Mask M1_POK_INT.	

**BUCK\_STAT BUCK Status Register**

ADDRESS	MODE		TYPE: O	RESET VALUE: N/A
0x22	R			
BIT	NAME	POR	DESCRIPTION	
7:4	RESERVED	0000		
3	M4_POK	0	BUCK Master 4 POK Status	
2	M3_POK	0	BUCK Master 3 POK Status	
1	M2_POK	0	BUCK Master 2 POK Status	
0	M1_POK	0	BUCK Master 1 POK Status	

**M1\_VOUT BUCK Master1 Output Voltage Setting Register**

ADDRESS	MODE		TYPE: O (OTP)	RESET VALUE: 0x50
0x23	R/W			
BIT	NAME	POR	DESCRIPTION	
7:0	M1_VOUT[7:0]	01010000	BUCK Master 1 Output Voltage	

**M2\_VOUT BUCK Master 2 Output Voltage Setting Register**

ADDRESS	MODE		TYPE: O (OTP)	RESET VALUE: 0x50
0x24	R/W			
BIT	NAME	POR	DESCRIPTION	
7:0	M2_VOUT[7:0]	01010000	BUCK Master 2 Output Voltage	

**M3\_VOUT BUCK Master 3 Output Voltage Setting Register**

ADDRESS	MODE		TYPE: O (OTP)	RESET VALUE: 0x46
0x25	R/W			
BIT	NAME	POR	DESCRIPTION	
7:0	M3_VOUT[7:0]	01000110	BUCK Master 3 Output Voltage	

**M4\_VOUT BUCK Master 4 Output Voltage Setting Register**

ADDRESS	MODE		TYPE: O (OTP)	RESET VALUE: 0x46
0x26	R/W			
BIT	NAME	POR	DESCRIPTION	
7:0	M4_VOUT[7:0]	01000110	BUCK Master 4 Output Voltage	

**M1\_VOUT\_D BUCK Master 1 Default Output Voltage Setting Register**

ADDRESS	MODE		TYPE: O	RESET VALUE: 0x78
0x27	R/W			
BIT	NAME	POR	DESCRIPTION	
7:0	M1_VOUT_D[7:0]	0111 1000	Buck Master 1 Default Output Voltage. Sets the output voltage when DVS = 1 through a GPI.	

**M2\_VOUT\_D BUCK Master 2 Default Output Voltage Setting Register**

ADDRESS	MODE		TYPE: O	RESET VALUE: 0x78
0x28	R/W			
BIT	NAME	POR	DESCRIPTION	
7:0	M2_VOUT_D[7:0]	0111 1000	Buck Master 2 Default Output Voltage. Sets the output voltage when DVS = 1 through a GPI.	

**M3\_VOUT\_D BUCK Master 3 Default Output Voltage Setting Register**

ADDRESS	MODE		TYPE: O	RESET VALUE: 0x78
0x29	R/W			
BIT	NAME	POR	DESCRIPTION	
7:0	M3_VOUT_D[7:0]	0111 1000	Buck Master 3 Default Output Voltage. Sets the output voltage when DVS = 1 through a GPI.	

**M4\_VOUT\_D BUCK Master 4 Default Output Voltage Setting Register**

ADDRESS	MODE		TYPE: O	RESET VALUE: 0x78
0x2A	R/W			
BIT	NAME	POR	DESCRIPTION	
7:0	M4_VOUT_D[7:0]	0111 1000	Buck Master 4 Default Output Voltage. Sets the output voltage when DVS = 1 through a GPI.	

**M1\_VOUT\_S BUCK Master1 Sleep Mode Output Voltage Setting Register**

ADDRESS	MODE		TYPE: O	RESET VALUE: 0x1E
0x2B	R/W			
BIT	NAME	POR	DESCRIPTION	
7:0	M1_VOUT_S[7:0]	0001 1110	Buck Master 1 Sleep Mode Output Voltage. Sets the output voltage when DVS = 0 through a GPI.	

**M2\_VOUT\_S BUCK Master 2 Sleep Mode Output Voltage Setting Register**

ADDRESS	MODE		TYPE: O	RESET VALUE: 0x1E
0x2C	R/W			
BIT	NAME	POR	DESCRIPTION	
7:0	M2_VOUT_S[7:0]	0001 1110	Buck Master 2 Sleep Mode Output Voltage. Sets the output voltage when DVS = 0 through a GPI.	



**M3\_VOUT\_S BUCK Master 3 Sleep Mode Output Voltage Setting Register**

ADDRESS	MODE		TYPE: O	RESET VALUE: 0x1E
0x2D	R/W			
BIT	NAME	POR	DESCRIPTION	
7:0	M3_VOUT_S[7:0]	0001 1110	Buck Master 3 Sleep Mode Output Voltage. Sets the output voltage when DVS = 0 through a GPI.	

**M4\_VOUT\_S BUCK Master 4 Sleep Mode Output Voltage Setting Register**

ADDRESS	MODE		TYPE: O	RESET VALUE: 0x1E
0x2E	R/W			
BIT	NAME	POR	DESCRIPTION	
7:0	M4_VOUT_S[7:0]	0001 1110	Buck Master 4 Sleep Mode Output Voltage. Sets the output voltage when DVS = 0 through a GPI.	

**Buck Output Voltage Table**

0x00 = 0.25000V	0x20 = 0.41000V	0x40 = 0.57000V	0x60 = 0.73000V	0x80 = 0.89000V	0xA0 = 1.05000V	0xC0 = 1.21000V	0xE0 = 1.37000V
0x01 = 0.25500V	0x21 = 0.41500V	0x41 = 0.57500V	0x61 = 0.73500V	0x81 = 0.89500V	0xA1 = 1.05500V	0xC1 = 1.21500V	0xE1 = 1.37500V
0x02 = 0.26000V	0x22 = 0.42000V	0x42 = 0.58000V	0x62 = 0.74000V	0x82 = 0.90000V	0xA2 = 1.06000V	0xC2 = 1.22000V	0xE2 = 1.38000V
0x03 = 0.26500V	0x23 = 0.42500V	0x43 = 0.58500V	0x63 = 0.74500V	0x83 = 0.90500V	0xA3 = 1.06500V	0xC3 = 1.22500V	0xE3 = 1.38500V
0x04 = 0.27000V	0x24 = 0.43000V	0x44 = 0.59000V	0x64 = 0.75000V	0x84 = 0.91000V	0xA4 = 1.07000V	0xC4 = 1.23000V	0xE4 = 1.39000V
0x05 = 0.27500V	0x25 = 0.43500V	0x45 = 0.59500V	0x65 = 0.75500V	0x85 = 0.91500V	0xA5 = 1.07500V	0xC5 = 1.23500V	0xE5 = 1.39500V
0x06 = 0.28000V	0x26 = 0.44000V	0x46 = 0.60000V	0x66 = 0.76000V	0x86 = 0.92000V	0xA6 = 1.08000V	0xC6 = 1.24000V	0xE6 = 1.40000V
0x07 = 0.28500V	0x27 = 0.44500V	0x47 = 0.60500V	0x67 = 0.76500V	0x87 = 0.92500V	0xA7 = 1.08500V	0xC7 = 1.24500V	0xE7 = 1.40500V
0x08 = 0.29000V	0x28 = 0.45000V	0x48 = 0.61000V	0x68 = 0.77000V	0x88 = 0.93000V	0xA8 = 1.09000V	0xC8 = 1.25000V	0xE8 = 1.41000V
0x09 = 0.29500V	0x29 = 0.45500V	0x49 = 0.61500V	0x69 = 0.77500V	0x89 = 0.93500V	0xA9 = 1.09500V	0xC9 = 1.25500V	0xE9 = 1.41500V
0x0A = 0.30000V	0x2A = 0.46000V	0x4A = 0.62000V	0x6A = 0.78000V	0x8A = 0.94000V	0xAA = 1.10000V	0xCA = 1.26000V	0xEA = 1.42000V
0x0B = 0.30500V	0x2B = 0.46500V	0x4B = 0.62500V	0x6B = 0.78500V	0x8B = 0.94500V	0xAB = 1.10500V	0xCB = 1.26500V	0xEB = 1.42500V
0x0C = 0.31000V	0x2C = 0.47000V	0x4C = 0.63000V	0x6C = 0.79000V	0x8C = 0.95000V	0xAC = 1.11000V	0xCC = 1.27000V	0xEC = 1.43000V
0x0D = 0.31500V	0x2D = 0.47500V	0x4D = 0.63500V	0x6D = 0.79500V	0x8D = 0.95500V	0xAD = 1.11500V	0xCD = 1.27500V	0xED = 1.43500V

## Buck Output Voltage Table (continued)

0x0E = 0.32000V	0x2E = 0.48000V	0x4E = 0.64000V	0x6E = 0.80000V	0x8E = 0.96000V	0xAE = 1.12000V	0xCE = 1.28000V	0xEE = 1.44000V
0x0F = 0.32500V	0x2F = 0.48500V	0x4F = 0.64500V	0x6F = 0.80500V	0x8F = 0.96500V	0xAF = 1.12500V	0xCF = 1.28500V	0xEF = 1.44500V
0x10 = 0.33000V	0x30 = 0.49000V	0x50 = 0.65000V	0x70 = 0.81000V	0x90 = 0.97000V	0xB0 = 1.13000V	0xD0 = 1.29000V	0xF0 = 1.45000V
0x11 = 0.33500V	0x31 = 0.49500V	0x51 = 0.65500V	0x71 = 0.81500V	0x91 = 0.97500V	0xB1 = 1.13500V	0xD1 = 1.29500V	0xF1 = 1.45500V
0x12 = 0.34000V	0x32 = 0.50000V	0x52 = 0.66000V	0x72 = 0.82000V	0x92 = 0.98000V	0xB2 = 1.14000V	0xD2 = 1.30000V	0xF2 = 1.46000V
0x13 = 0.34500V	0x33 = 0.50500V	0x53 = 0.66500V	0x73 = 0.82500V	0x93 = 0.98500V	0xB3 = 1.14500V	0xD3 = 1.30500V	0xF3 = 1.46500V
0x14 = 0.35000V	0x34 = 0.51000V	0x54 = 0.67000V	0x74 = 0.83000V	0x94 = 0.99000V	0xB4 = 1.15000V	0xD4 = 1.31000V	0xF4 = 1.47000V
0x15 = 0.35500V	0x35 = 0.51500V	0x55 = 0.67500V	0x75 = 0.83500V	0x95 = 0.99500V	0xB5 = 1.15500V	0xD5 = 1.31500V	0xF5 = 1.47500V
0x16 = 0.36000V	0x36 = 0.52000V	0x56 = 0.68000V	0x76 = 0.84000V	0x96 = 1.00000V	0xB6 = 1.16000V	0xD6 = 1.32000V	0xF6 = 1.48000V
0x17 = 0.36500V	0x37 = 0.52500V	0x57 = 0.68500V	0x77 = 0.84500V	0x97 = 1.00500V	0xB7 = 1.16500V	0xD7 = 1.32500V	0xF7 = 1.48500V
0x18 = 0.37000V	0x38 = 0.53000V	0x58 = 0.69000V	0x78 = 0.85000V	0x98 = 1.01000V	0xB8 = 1.17000V	0xD8 = 1.33000V	0xF8 = 1.49000V
0x19 = 0.37500V	0x39 = 0.53500V	0x59 = 0.69500V	0x79 = 0.85500V	0x99 = 1.01500V	0xB9 = 1.17500V	0xD9 = 1.33500V	0xF9 = 1.49500V
0x1A = 0.38000V	0x3A = 0.54000V	0x5A = 0.70000V	0x7A = 0.86000V	0x9A = 1.02000V	0xBA = 1.18000V	0xDA = 1.34000V	0xFA = 1.50000V
0x1B = 0.38500V	0x3B = 0.54500V	0x5B = 0.70500V	0x7B = 0.86500V	0x9B = 1.02500V	0xBB = 1.18500V	0xDB = 1.34500V	0xFB = 1.50500V
0x1C = 0.39000V	0x3C = 0.55000V	0x5C = 0.71000V	0x7C = 0.87000V	0x9C = 1.03000V	0xBC = 1.19000V	0xDC = 1.35000V	0xFC = 1.51000V
0x1D = 0.39500V	0x3D = 0.55500V	0x5D = 0.71500V	0x7D = 0.87500V	0x9D = 1.03500V	0xBD = 1.19500V	0xDD = 1.35500V	0xFD = 1.51500V
0x1E = 0.40000V	0x3E = 0.56000V	0x5E = 0.72000V	0x7E = 0.88000V	0x9E = 1.04000V	0xBE = 1.20000V	0xDE = 1.36000V	0xFE = 1.52000V
0x1F = 0.40500V	0x3F = 0.56500V	0x5F = 0.72500V	0x7F = 0.88500V	0x9F = 1.04500V	0xBF = 1.20500V	0xDF = 1.36500V	0xFF = 1.52500V

## M1\_CFG BUCK Master 1 Configuration Register

ADDRESS	MODE		TYPE: O	RESET VALUE: 0xD1
0x2F	R/W			
BIT	NAME	POR	DESCRIPTION	
7	M1_AD	1	BUCK Master 1 Output Active Discharge 0: Disable 1: Enable	
6:4	M1_ILIM[2:0]	101	BUCK Master 1 PMOS Peak/NMOS Valley Current Limit Setting 000b: 3.0A/2.0A 001b: 3.6A/2.4A 010b: 4.2A/2.8A 011b: 4.8A/3.2A 100b: 5.4A/3.6A 101b: 6.0A/4.0A 110b: 6.6A/4.4A 111b: 7.2A/4.8A	
2:3	RESERVED	00	Write '00'	
1	M1_FPWM	0	BUCK Master 1 Forced PWM 0: Turn off Forced PWM (Automatic skip mode operation under light load) 1: Turn on Forced PWM mode	
0	M1_FSREN	1	<p>BUCK Master 1 Falling Slew Rate Control 0: Disable BUCK Master 1 operates in skip mode during the output voltage ramp-down (only if M1_FPWM = 0). In skip mode, negative current through the low-side FET is not allowed so that the output voltage falling slew rate is a function of the output capacitance and the external load under light load condition. If the load is heavy, the output voltage falling slew rate is limited to the ramp-down slew rate set by B_RD_SR[1:0]. Note that the internal feedback string always imposes a 2<math>\mu</math>A load on the output.</p> <p>1: Enable BUCK Master 1 operates in Forced PWM mode during the output voltage ramp-down. In Forced PWM mode, BUCK Master 1 can sink current from the output capacitor to ensure that the output voltage decreases at the ramp-down slew rate set by B_RD_SR[1:0]. To ensure a smooth output voltage ramp-down, Forced PWM mode remains engaged for 50<math>\mu</math>s after the output voltage decreases to its target voltage.</p>	

**M2\_CFG BUCK Master 2 Configuration Register**

ADDRESS	MODE		TYPE: O	RESET VALUE: 0xD1
0x30	R/W			
BIT	NAME	POR	DESCRIPTION	
7	M2_AD	1	BUCK Master 2 Output Active Discharge 0: Disable 1: Enable	
6:4	M2_ILIM[2:0]	101	BUCK Master 2 PMOS Peak/NMOS Valley Current Limit Setting 000b: 3.0A/2.0A 001b: 3.6A/2.4A 010b: 4.2A/2.8A 011b: 4.8A/3.2A 100b: 5.4A/3.6A 101b: 6.0A/4.0A 110b: 6.6A/4.4A 111b: 7.2A/4.8A	
2:3	RESERVED	00	Write '00'	
1	M2_FPWM	0	BUCK Master 2 Forced PWM 0: Turn off Forced PWM (Automatic skip mode operation under light load) 1: Turn on Forced PWM mode	
0	M2_FSREN	1	<p>BUCK Master 2 Falling Slew Rate Control 0: Disable BUCK Master 2 operates in skip mode during the output voltage ramp-down (only if M2_FPWM = 0). In skip mode, negative current through the low-side FET is not allowed so that the output voltage falling slew rate is a function of the output capacitance and the external load under light load condition. If the load is heavy, the output voltage falling slew rate is limited to the ramp-down slew rate set by B_RD_SR[1:0]. Note that the internal feedback string always imposes a 2µA load on the output.</p> <p>1: Enable BUCK Master 2 operates in Forced PWM mode during the output voltage ramp-down. In Forced PWM mode, BUCK Master 2 can sink current from the output capacitor to ensure that the output voltage decreases at the ramp-down slew rate set by B_RD_SR[1:0]. To ensure a smooth output voltage ramp-down, Forced PWM mode remains engaged for 50µs after the output voltage decreases to its target voltage.</p>	

**M3\_CFG BUCK Master 3 Configuration Register**

ADDRESS	MODE		TYPE: O	RESET VALUE: 0xD1
0x31	R/W			
BIT	NAME	POR	DESCRIPTION	
7	M3_AD	1	BUCK Master 3 Output Active Discharge 0: Disable 1: Enable	
6:4	M3_ILIM[2:0]	101	BUCK Master 3 PMOS Peak/NMOS Valley Current Limit Setting 000b: 3.0A/2.0A 001b: 3.6A/2.4A 010b: 4.2A/2.8A 011b: 4.8A/3.2A 100b: 5.4A/3.6A 101b: 6.0A/4.0A 110b: 6.6A/4.4A 111b: 7.2A/4.8A	
2:3	RESERVED	00	Write '00'	
1	M3_FPWM	0	BUCK Master 3 Forced PWM 0: Turn off Forced PWM (Automatic skip mode operation under light load) 1: Turn on Forced PWM mode	
0	M3_FSREN	1	BUCK Master 3 Falling Slew Rate Control 0: Disable BUCK Master 3 operates in skip mode during the output voltage ramp-down (only if M3_FPWM = 0). In skip mode, negative current through the low-side FET is not allowed so that the output voltage falling slew rate is a function of the output capacitance and the external load under light load condition. If the load is heavy, the output voltage falling slew rate will be limited to the ramp-down slew rate set by B_RD_SR[1:0]. Note that the internal feedback string always imposes a 2µA load on the output. 1: Enable BUCK Master 3 operates in Forced PWM mode during the output voltage ramp-down. In Forced PWM mode, BUCK Master 3 can sink current from the output capacitor to ensure that the output voltage decreases at the ramp-down slew rate set by B_RD_SR[1:0]. To ensure a smooth output voltage ramp-down, Forced PMW mode remains engaged for 50µs after the output voltage decreases to its target voltage.	

## M4\_CFG BUCK Master 4 Configuration Register

ADDRESS	MODE		TYPE: O	RESET VALUE: 0xD1
0x32	R/W			
BIT	NAME	POR	DESCRIPTION	
7	M4_AD	1	BUCK Master 4 Output Active Discharge 0: Disable 1: Enable	
6:4	M4_ILIM[2:0]	101	BUCK Master 4 PMOS Peak/NMOS Valley Current Limit Setting 000b: 3.0A/2.0A 001b: 3.6A/2.4A 010b: 4.2A/2.8A 011b: 4.8A/3.2A 100b: 5.4A/3.6A 101b: 6.0A/4.0A 110b: 6.6A/4.4A 111b: 7.2A/4.8A	
2:3	RESERVED	00	Write '00'	
1	M4_FPWM	0	BUCK Master4 Forced PWM 0: Turn off Forced PWM (Automatic skip mode operation under light load) 1: Turn on Forced PWM mode	
0	M4_FSREN	1	<p>BUCK Master 4 Falling Slew Rate Control 0: Disable BUCK Master 4 operates in skip mode during the output voltage ramp-down (only if M4_FPWM = 0). In skip mode, negative current through the low-side FET is not allowed so that the output voltage falling slew rate is a function of the output capacitance and the external load under light load condition. If the load is heavy, the output voltage falling slew rate is limited to the ramp-down slew rate set by B_RD_SR[1:0]. Note that the internal feedback string always imposes a 2µA load on the output.</p> <p>1: Enable BUCK Master 4 operates in Forced PWM mode during the output voltage ramp-down. In Forced PWM mode, BUCK Master 4 can sink current from the output capacitor to ensure that the output voltage decreases at the ramp-down slew rate set by B_RD_SR[1:0]. To ensure a smooth output voltage ramp-down, Forced PMW mode remains engaged for 50µs after the output voltage decreases to its target voltage.</p>	

## GLB\_CFG1 BUCK Global Configuration Register 1

ADDRESS	MODE		TYPE: O	RESET VALUE: 0x24
0x33	R/W			
BIT	NAME	POR	DESCRIPTION	
7	RESERVED	0		
6:4	B_SD_SR[2:0]	010	Shutdown Slew Rate 000b: 1.25mV/μs 001b: 2.5mV/μs 010b: 5mV/μs 011b: 10mV/μs 100b: 20mV/μs 101b: 40mV/μs 110b: 60mV/μs 111b: 60mV/μs	
3	RESERVED	0		
0:2	B_SS_SR[2:0]	100	Soft Start Slew Rate 000b: 1.25mV/μs 001b: 2.5mV/μs 010b: 5mV/μs 011b: 10mV/μs 100b: 20mV/μs 101b: 40mV/μs 110b: 60mV/μs 111b: 60mV/μs	

## GLB\_CFG2 BUCK Global Configuration Register 2

ADDRESS	MODE		TYPE: O	RESET VALUE: 0x24
0x34	R/W			
BIT	NAME	POR	DESCRIPTION	
7	RESERVED	0		
6:4	B_RD_SR[2:0]	010	Ramp-Down Slew Rate 000b: 1.25mV/μs 001b: 2.5mV/μs 010b: 5mV/μs 011b: 10mV/μs 100b: 20mV/μs 101b: 40mV/μs 110b: 60mV/μs 111b: 60mV/μs	
3	RESERVED	0		
0:2	B_RU_SR[2:0]	100	Ramp-Up Slew Rate 000b: 1.25mV/μs 001b: 2.5mV/μs 010b: 5mV/μs 011b: 10mV/μs 100b: 20mV/μs 101b: 40mV/μs 110b: 60mV/μs 111b: 60mV/μs	



**GLB\_CFG3 BUCK Global Configuration Register 3**

ADDRESS	MODE		TYPE: 0	RESET VALUE: 0x5F
0x35	R/W			
BIT	NAME	POR	DESCRIPTION	
7	RESERVED	0		
6	RESERVED	1		
5	RESERVED	0		
4	RESERVED	1		
3	RESERVED	1		
2	RESERVED	1		
1	B_PETR_EN	1	Positive Enhanced Transient Response Control 0: Disable 1: Enable	
0	B_NETR_EN	1	Negative Enhanced Transient Response Control 0: Disable 1: Enable	

0x36 – 0xFF: RESERVED

**PCB Layout Guidelines**

Careful circuit board layout is critical to low-power switching losses and clean stable operation.

For more details on PCB layout recommendations for the MAX77812, refer to [Application Note 6819: MAX77812 PCB Layout Guide](#).

Simplified Block Diagram

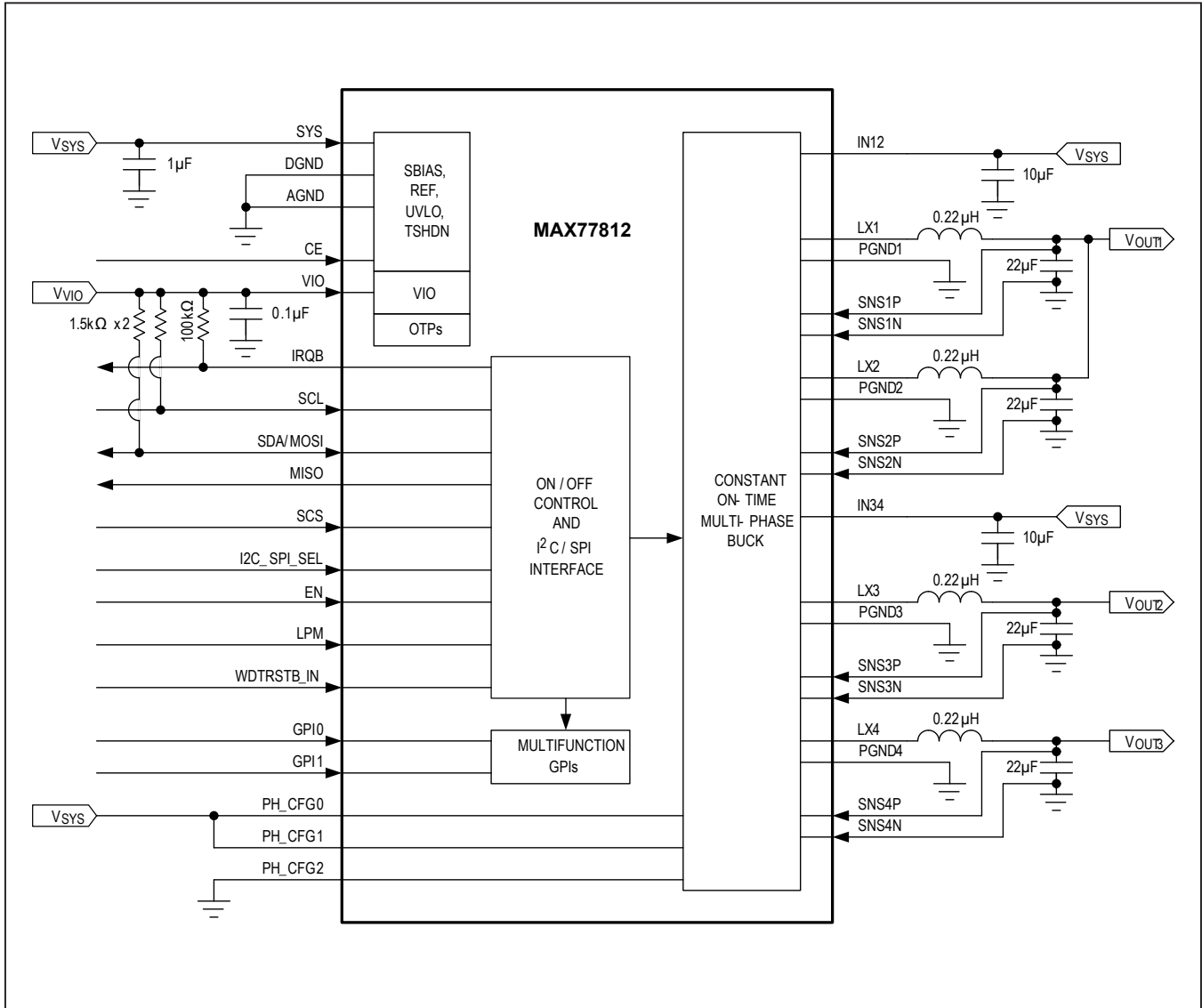

Ordering Information

PART	DEFAULT OUTPUT VOLTAGE (V)				STARTUP DELAY TIME (ms)			I <sup>2</sup> C SLAVE ADDRESS
	M1_VOUT	M2_VOUT	M3_VOUT	M4_VOUT	M2_STUP_DLY	M3_STUP_DLY	M4_STUP_DLY	
MAX77812EWB+T	0.650	0.650	0.600	0.600	0	0	0	0x60-0x69
MAX77812AEWB+T	0.700	0.700	0.800	1.100	0	0	2	0x60-0x69
MAX77812BEWB+T	1.120	1.120	0.920	0.950	0	0	0	0x60-0x69
MAX77812CEWB+T	0.720	1.495	0.820	0.820	5	1	3	0x60-0x69
MAX77812DEWB+T	0.720	1.200	0.900	0.750	3	6	9	0x60-0x69
MAX77812FEWB+T	0.620	1.100	0.900	1.495	0	0	0	0x70-0x79

+Denotes a lead(Pb)-free/RoHS-compliant package.  
T = Tape and reel.

Package Information

For the latest package outline information and land patterns (footprints), go to [www.maximintegrated.com/packages](http://www.maximintegrated.com/packages). Note that a "+", "#", or "-" in the package code indicates RoHS status only. Package drawings may show a different suffix character, but the drawing pertains to the package regardless of RoHS status.

PACKAGE TYPE	PACKAGE CODE	OUTLINE NO.	LAND PATTERN NO.
64 WLP	W643C3+1	<a href="#">21-100087</a>	Refer to <a href="#">Application Note 1891: Wafer-Level Packaging (WLP) and Its Applications</a>

## Revision History

REVISION NUMBER	REVISION DATE	DESCRIPTION	PAGES CHANGED
0	6/16	Initial release	—
1	3/17	Updated <i>Applications</i> section, updated <i>Benefits and Features</i> section, updated MIN/TYP/MAX values in the <i>Electrical Characteristics</i> section and changed inductor to 220nH, DCR = 16mΩ, added Cyntec information to <i>Table 2</i> , added I <sup>2</sup> C slave addresses for OTP = 1 to <i>Table 5</i> , updated Figures 6–9 and communication protocols description, updated GPI_FUNC, M1_CFG, M2_CFG, M3_CFG, M4_CFG, GLB_CFG1, GLB_CFG2 registers in the <i>Register Map</i> table, updated <i>Typical Application Circuit</i>	1–14, 29, 32–36, 42, 43, 49, 56, 60–66
2	6/17	Updated <i>Benefits and Features</i> section and <i>Register Map</i> table, fixed various typos	1, 2, 4–6, 8, 11, 12, 14, 15, 23, 25, 26, 31, 33–38, 42, 43, 46–48, 62–64
3	8/17	Updated title, <i>Benefits and Features</i> section, and <i>Electrical Characteristics</i> table, corrected label error to Output Voltage Error (%) in <i>Typical Operating Characteristics</i> , corrected errors to register name and removed error statement in HS mode in <i>Detailed Description</i> section, removed inductor from <i>Table 2</i> , corrected error in POR bits in the <i>GPI_PD_CTRL GPI Pulldown Resistor Control Register</i> table	1, 10, 14, 16, 26, 29, 30, 38, 51
4	1/18	Updated <i>Applications</i> and <i>Benefits and Features</i> sections, added <i>Simplified Block Diagram</i> , added LX1/2/3/4 pulsed ratings, updated <i>Electrical Characteristics</i> tables, updated <i>Detailed Description</i> section, added ALPS 220nH, removed process information	1–4, 11, 15, 26–29, 30, 31, 38, 67
5	5/18	Updated <i>General Description</i> , <i>Benefits and Features</i> , and <i>Applications</i> sections, renamed <i>Typical Application Circuit</i> and moved to page 1, updated <i>Absolute Maximum Ratings</i> for LXx RMS current, updated <i>Electrical Characteristics</i> tables, updated <i>Typical Operating Characteristics</i> global conditions and TOCs, updated <i>Detailed Description</i> sections, Table 1, Figure 2, Table 5, corrected errors in Registers information, renamed <i>Simplified Block Diagram</i> and updated to 2+1+1 configuration, updated <i>Ordering Information</i> table	1–3, 14, 16, 17, 26, 28–30, 32, 34, 35, 47–50, 59–62, 66, 67
6	7/18	Corrected typo in <i>Electrical Characteristics</i> table and other sections, updated <i>Ordering Information</i> table	1, 13, 22, 24–43, 53, 63, 65
7	6/19	Updated Table 5 and <i>Ordering Information</i> table	32, 65
8	8/19	Updated <i>Typical Operating Characteristics</i> global conditions and TOCs, corrected label error to Output Voltage Error (%) in <i>Typical Operating Characteristics</i> , updated <i>Output Voltage Setting</i> section, added <i>Enhanced Transient Response</i> section, and added <i>PCB Layout Guidelines</i> section	14–15, 28–29, 63
9	9/19	Updated <i>Typical Operating Characteristics</i> section	14–22

## Revision History (continued)

REVISION NUMBER	REVISION DATE	DESCRIPTION	PAGES CHANGED
10	4/20	Updated <i>Startup and Shutdown Sequence</i> section, <i>Phase/Output Configurations</i> section, <i>Multifunction GPIOs General Description</i> section, <i>Register Map</i> table, M1_VOUT_D, M2_VOUT_D, M3_VOUT_D, M4_VOUT_D, M1_VOUT_S, M2_VOUT_S, M3_VOUT_S, and M4_VOUT_S register descriptions, and <i>GLB_CFG3 BUCK Global Configuration Register 3</i> table; added <i>Inductor Current Limit</i> section and <i>Unused Outputs</i> section	27–28, 31–32, 45, 56–57, 65
11	12/20	Updated <i>Absolute Maximum Ratings</i> section, added <i>Recommended Operating Conditions</i> table, and updated global conditions in <i>Electrical Characteristics</i> tables	1–13

For pricing, delivery, and ordering information, please visit Maxim Integrated's online storefront at <https://www.maximintegrated.com/en/storefront/storefront.html>.

Maxim Integrated cannot assume responsibility for use of any circuitry other than circuitry entirely embodied in a Maxim Integrated product. No circuit patent licenses are implied. Maxim Integrated reserves the right to change the circuitry and specifications without notice at any time. The parametric values (min and max limits) shown in the *Electrical Characteristics* table are guaranteed. Other parametric values quoted in this data sheet are provided for guidance.

# Mouser Electronics

Authorized Distributor

Click to View Pricing, Inventory, Delivery & Lifecycle Information:

## Maxim Integrated:

[MAX77812EWB+](#) [MAX77812AEWB+T](#) [MAX77812BEWB+T](#) [MAX77812CEWB+T](#) [MAX77812EWB+T](#)  
[MAX77812DEWB+T](#) [MAX77812FEWB+T](#)