

DS90LV028AQ-Q1 Automotive LVDS Dual Differential Line Receiver

1 Features

- AECQ-100 Qualified for Automotive Applications
 - Temperature Grade 1: -40°C to +125°C T_A
- >400 Mbps (200 MHz) Switching Rates
- 50 ps Differential Skew (Typical)
- 0.1 ns Channel-to-Channel Skew (Typical)
- 2.5 ns Maximum Propagation Delay
- 3.3V Power Supply Design
- Flow-Through Pinout
- Power Down High Impedance on LVDS Inputs
- Low Power design (18 mW at 3.3 V static)
- LVDS Inputs Accept LVDS/CML/LVPECL Signals
- Conforms to ANSI/TIA/EIA-644 Standard
- Available in SOIC Package

2 Applications

- LVDS-to-LVCMOS Translation
- [Infotainment and Cluster](#)
- [Automotive Head Unit](#)

3 Description

The DS90LV028AQ is a dual CMOS differential line receiver designed for applications requiring ultra low power dissipation, low noise and high data rates. The device is designed to support data rates in excess of 400 Mbps (200 MHz) utilizing Low Voltage Differential Signaling (LVDS) technology.

The DS90LV028AQ accepts low voltage (350 mV typical) differential input signals and translates them to 3 V CMOS output levels. The DS90LV028AQ has a flow-through design for easy PCB layout.

The DS90LV028AQ and companion LVDS line driver DS90LV027AQ provide a new alternative to high power PECL/ECL devices for high speed point-to-point interface applications.

Device Information⁽¹⁾

PART NUMBER	PACKAGE	BODY SIZE (NOM)
DS90LV028AQ	SOIC (D 8)	4.90 mm x 3.91 mm

(1) For all available packages, see the orderable addendum at the end of the data sheet.

(2) Product Preview

Functional Diagram

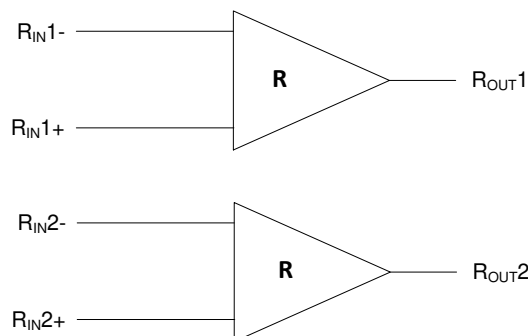

Table of Contents

1 Features	1	8.1 Functional Block Diagram	9
2 Applications	1	8.2 Device Functional Modes.....	9
3 Description	1	9 Application and Implementation	10
4 Revision History	2	9.1 Application Information.....	10
5 Pin Configuration and Functions	3	9.2 Typical Application	10
6 Specifications	4	10 Layout	12
6.1 Absolute Maximum Ratings	4	10.1 Layout Guidelines	12
6.2 ESD Ratings.....	4	11 Device and Documentation Support	13
6.3 Recommended Operating Conditions.....	4	11.1 Device Support	13
6.4 Thermal Information	4	11.2 Community Resources.....	13
6.5 Electrical Characteristics.....	5	11.3 Trademarks	13
6.6 Switching Characteristics	5	11.4 Electrostatic Discharge Caution.....	13
6.7 Typical Performance Curves.....	6	11.5 Glossary	13
7 Parameter Measurement Information	8	12 Mechanical, Packaging, and Orderable Information	13
8 Detailed Description	9		

4 Revision History

NOTE: Page numbers for previous revisions may differ from page numbers in the current version.

Changes from Revision H (May 2019) to Revision I Page

- Deleted DQF from Device Information table
- Deleted DQF package option

Changes from Revision G (November 2018) to Revision H Page

- Deleted the Thermal Pad from the DQF package.....
- Changed V_{CC} 0.3 To: $V_{CC} + 0.3$ in the *Absolute Maximum Ratings* table.....
- Added NOTE: "These parameters are specified by design."

Changes from Revision F (August 2018) to Revision G Page

- Changed the Pin image views
- Changed the Pin Descriptions format

Changes from Revision E (April 2013) to Revision F Page

- Added *Applications* list, *Device Information* table, *ESD Ratings* table, *Device Functional Modes*, *Application and Implementation* section, *Layout* section, *Device and Documentation Support* section.....
- Added the DQF package to the data sheet

Changes from Revision D (April 2013) to Revision E Page

- Changed layout of National Data Sheet to TI format

5 Pin Configuration and Functions

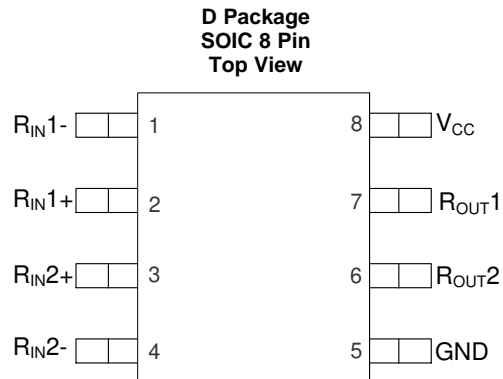

Pin Descriptions

Pin Number	Name	Description
1	R _{IN1-}	Inverting receiver input pin
4	R _{IN2-}	
2	R _{IN1+}	Non-inverting receiver input pin
3	R _{IN2+}	
6	R _{OUT2}	Receiver output pin
7	R _{OUT1}	
8	V _{CC}	Power supply pin, +3.3V +/- 0.3V
5	GND	Ground pin

6 Specifications

6.1 Absolute Maximum Ratings ⁽¹⁾⁽²⁾

		MIN	MAX	UNIT
Supply Voltage (V_{CC})		-0.3	4	V
Input Voltage (R_{IN+} , R_{IN-})		-0.3	3.9	V
Output Voltage (R_{OUT})		-0.3	$V_{CC} + 0.3$	V
Lead Temperature Range Soldering	(4 sec.)		260	°C
Maximum Junction Temperature			135	°C
Storage temperature, T_{stg}		-65	150	°C

- (1) Stresses beyond those listed under *Absolute Maximum Ratings* may cause permanent damage to the device. These are stress ratings only, which do not imply functional operation of the device at these or any other conditions beyond those indicated under *Recommended Operating Conditions*. Exposure to absolute-maximum-rated conditions for extended periods may affect device reliability.
- (2) If Military/Aerospace specified devices are required, please contact the Texas Instruments Sales Office/ Distributors for availability and specifications.

6.2 ESD Ratings

		VALUE	UNIT
$V_{(ESD)}$ Electrostatic discharge	Human-body model (HBM), per ANSI/ESDA/JEDEC JS-001 ⁽¹⁾	±8000	V
	Charged-device model (CDM), per JEDEC specification JESD22-C101 or ANSI/ESDA/JEDEC JS-002 ⁽²⁾	±1250	

- (1) JEDEC document JEP155 states that 500-V HBM allows safe manufacturing with a standard ESD control process.
- (2) JEDEC document JEP157 states that 250-V CDM allows safe manufacturing with a standard ESD control process.

6.3 Recommended Operating Conditions

	Min	Typ	Max	Units
Supply Voltage (V_{CC})	3	3.3	3.6	V
Receiver Input Voltage	GND		3	V
Operating Free Air Temperature (T_A)	-40	25	+125	°C

6.4 Thermal Information

THERMAL METRIC ⁽¹⁾		DS90LV028AQ		UNIT
		D (SOIC)		
		8 PINS		
$R_{\theta JA}$	Junction-to-ambient thermal resistance	103.0		°C/W
$R_{\theta JC(bot)}$	Junction-to-case (bottom) thermal resistance	41.0		°C/W

- (1) For more information about traditional and new thermal metrics, see the [Semiconductor and IC Package Thermal Metrics](#) application report.

6.5 Electrical Characteristics

Over Supply Voltage and Operating Temperature ranges, unless otherwise specified. ⁽¹⁾⁽²⁾

Symbol	Parameter	Conditions	Pin	Min	Typ	Max	Units
V _{TH}	Differential Input High Threshold	V _{CM} = +1.2 V, 0 V, 3 V	R _{IN+} , R _{IN-}			+100	mV
V _{TL}	Differential Input Low Threshold			-100			mV
I _{IN}	Input Current	V _{IN} = +2.8V	V _{CC} = 3.6 V or 0 V	-10	±1	+10	μA
		V _{IN} = 0V		-10	±1	+10	μA
		V _{IN} = +3.6V		V _{CC} = 0 V	-20		+20
V _{OH}	Output High Voltage	I _{OH} = -0.4 mA, V _{ID} = +200 mV	R _{OUT}	2.7	3.1		V
V _{OL}	Output Low Voltage	I _{OL} = 2 mA, V _{ID} = -200 mV			0.3	0.5	V
I _{OS}	Output Short Circuit Current	V _{OUT} = 0 V ⁽³⁾		-15	-50	-100	mA
V _{CL}	Input Clamp Voltage	I _{CL} = -18 mA		-1.5	-0.8		V
I _{CC}	No Load Supply Current	Inputs Open	V _{CC}		5.4	9	mA

- (1) Current into device pins is defined as positive. Current out of device pins is defined as negative. All voltages are referenced to ground unless otherwise specified (such as V_{ID}).
- (2) All typicals are given for: V_{CC} = +3.3V and T_A = +25°C.
- (3) Output short circuit current (I_{OS}) is specified as magnitude only, minus sign indicates direction only. Only one output should be shorted at a time, do not exceed maximum junction temperature specification.

6.6 Switching Characteristics⁽¹⁾

Over Supply Voltage and Operating Temperature ranges, unless otherwise specified. ⁽²⁾⁽³⁾⁽⁴⁾

Symbol	Parameter	Conditions	Min	Typ	Max	Units
t _{PHLD}	Differential Propagation Delay High to Low	C _L = 15 pF	1	1.6	2.5	ns
t _{PLHD}	Differential Propagation Delay Low to High	V _{ID} = 200 mV	1	1.7	2.5	ns
t _{SKD1}	Differential Pulse Skew t _{PHLD} - t _{PLHD} ⁽⁵⁾	(Figure 15 and Figure 16)	0	50	650	ps
t _{SKD2}	Differential Channel-to-Channel Skew-same device ⁽⁶⁾		0	0.1	0.5	ns
t _{SKD3}	Differential Part to Part Skew ⁽⁷⁾		0		1	ns
t _{SKD4}	Differential Part to Part Skew ⁽⁸⁾		0		1.5	ns
t _{TLH}	Rise Time			325	800	ps
t _{THL}	Fall Time			225	800	ps
f _{MAX}	Maximum Operating Frequency ⁽⁹⁾			250		MHz

- (1) These parameters are specified by design. The min/max limits are not tested in production and are based on statistical analysis of the device performance over PVT (process, voltage, temperature) ranges.
- (2) All typicals are given for: V_{CC} = +3.3V and T_A = +25°C.
- (3) C_L includes probe and jig capacitance.
- (4) Generator waveform for all tests unless otherwise specified: f = 1 MHz, Z_O = 50Ω, t_r and t_f (0% to 100%) ≤ 3 ns for R_{IN}.
- (5) t_{SKD1} is the magnitude difference in differential propagation delay time between the positive-going-edge and the negative-going-edge of the same channel.
- (6) t_{SKD2} is the differential channel-to-channel skew of any event on the same device. This specification applies to devices having multiple receivers within the integrated circuit.
- (7) t_{SKD3}, part to part skew, is the differential channel-to-channel skew of any event between devices. This specification applies to devices at the same V_{CC} and within 5°C of each other within the operating temperature range.
- (8) t_{SKD4}, part to part skew, is the differential channel-to-channel skew of any event between devices. This specification applies to devices over the recommended operating temperature and voltage ranges, and across process distribution. t_{SKD4} is defined as |Max - Min| differential propagation delay.
- (9) f_{MAX} generator input conditions: t_r = t_f < 1 ns (0% to 100%), 50% duty cycle, differential (1.05V to 1.35 peak to peak). Output criteria: 60%/40% duty cycle, V_{OL} (max 0.4V), V_{OH} (min 2.7V), load = 15 pF (stray plus probes).

6.7 Typical Performance Curves

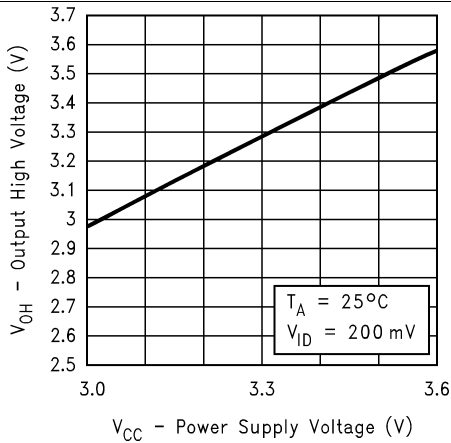

Figure 1. Output High Voltage vs Power Supply Voltage

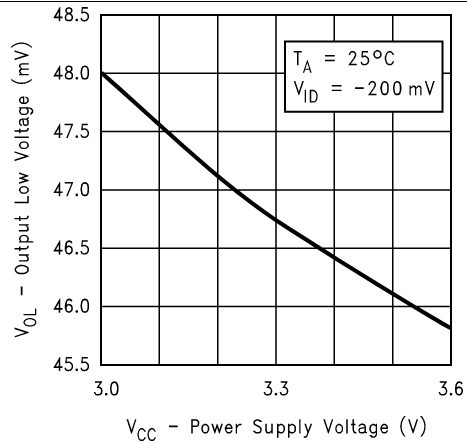

Figure 2. Output Low Voltage vs Power Supply Voltage

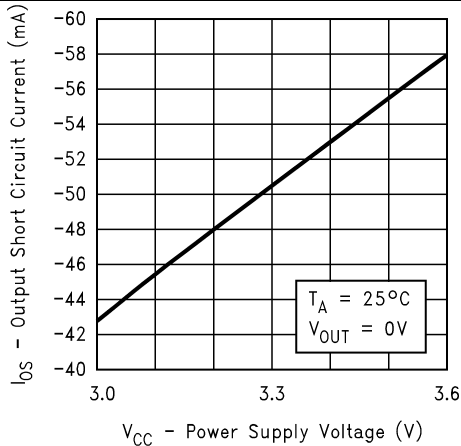

Figure 3. Output Short Circuit Current vs Power Supply Voltage

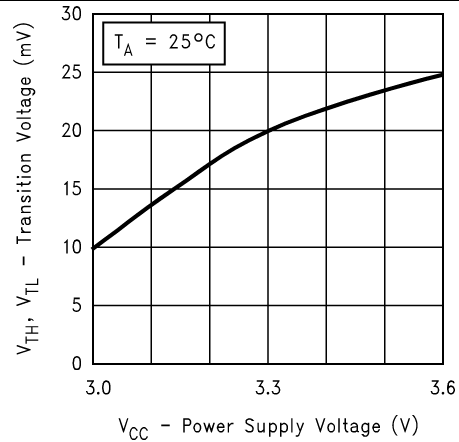

Figure 4. Differential Transition Voltage vs Power Supply Voltage

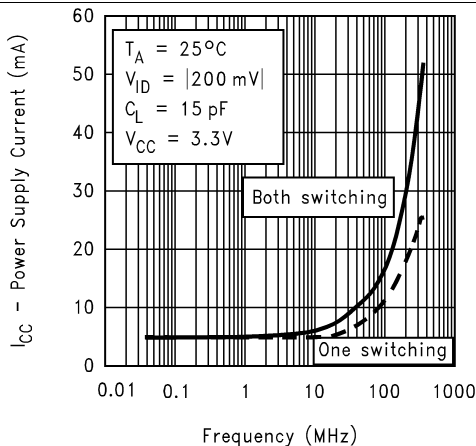

Figure 5. Power Supply Current vs Frequency

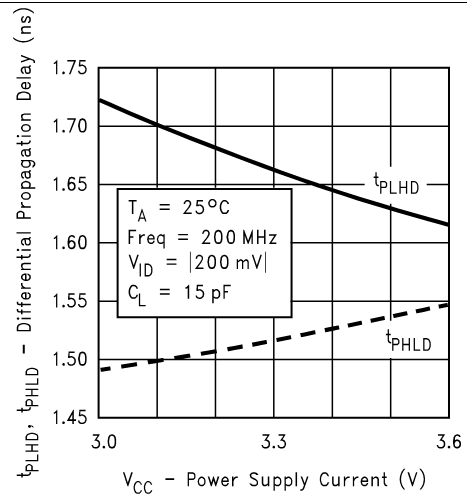

Figure 6. Differential Propagation Delay vs Power Supply Voltage

Typical Performance Curves (continued)

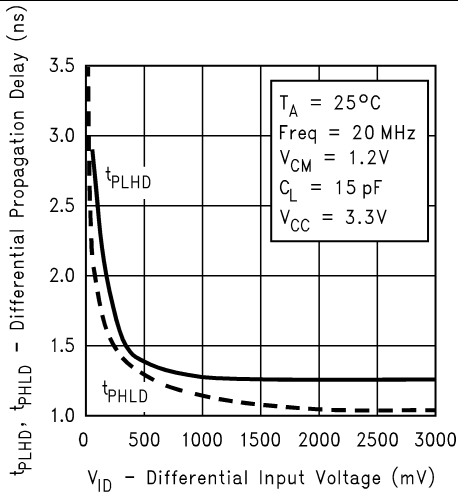

Figure 7. Differential Propagation Delay vs Differential Input Voltage

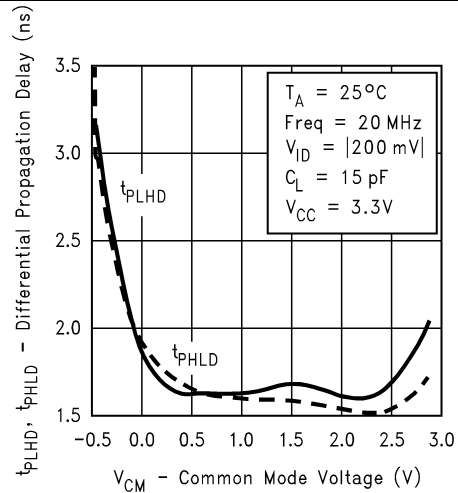

Figure 8. Differential Propagation Delay vs Common-Mode Voltage

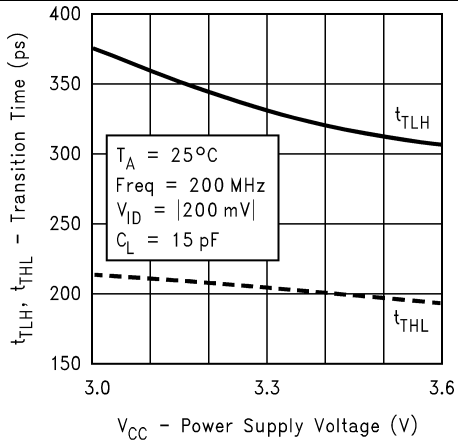

Figure 9. Transition Time vs Power Supply Voltage

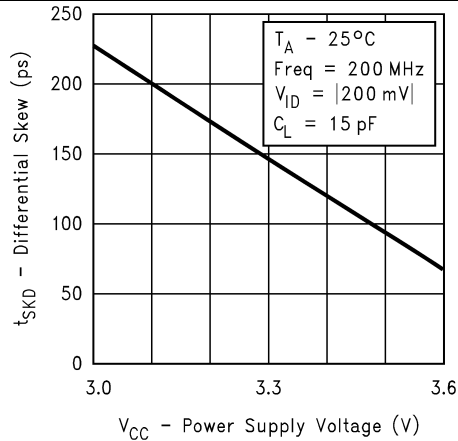

Figure 10. Differential Skew vs Power Supply Voltage

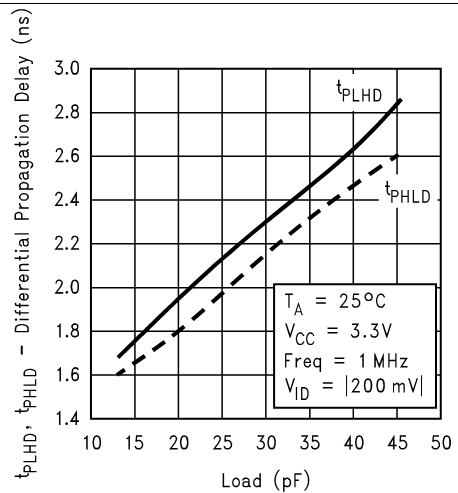

Figure 11. Differential Propagation Delay vs Load

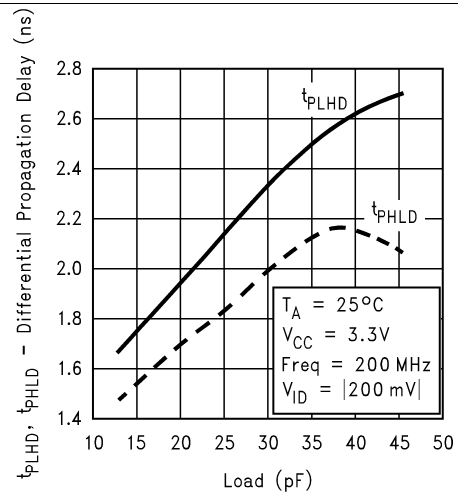
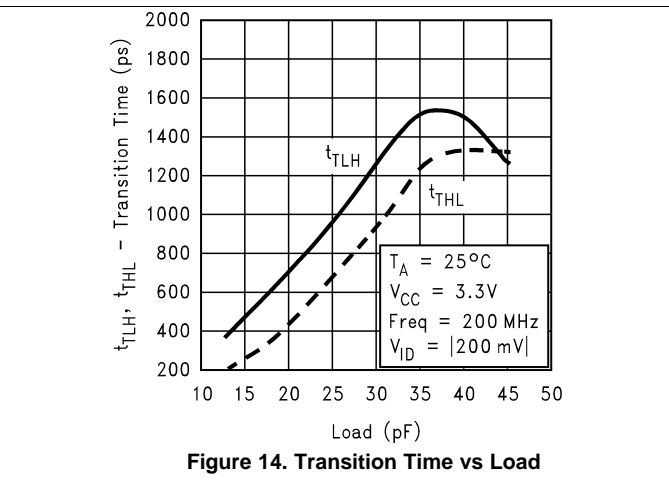
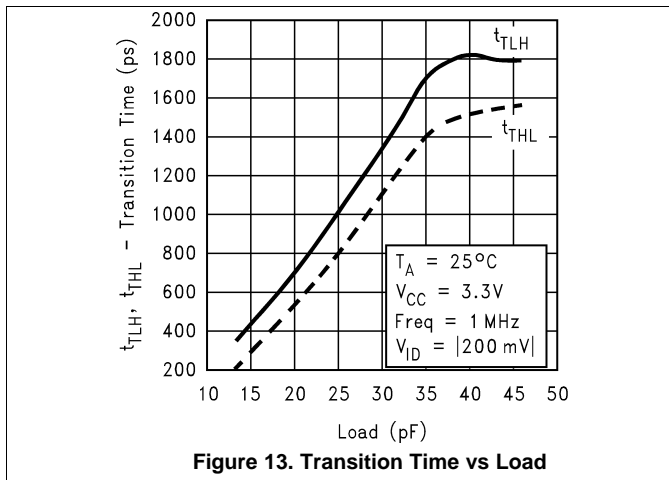

Figure 12. Differential Propagation Delay vs Load

Typical Performance Curves (continued)



7 Parameter Measurement Information

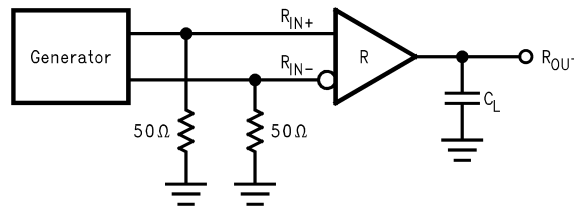

Figure 15. Receiver Propagation Delay and Transition Time Test Circuit

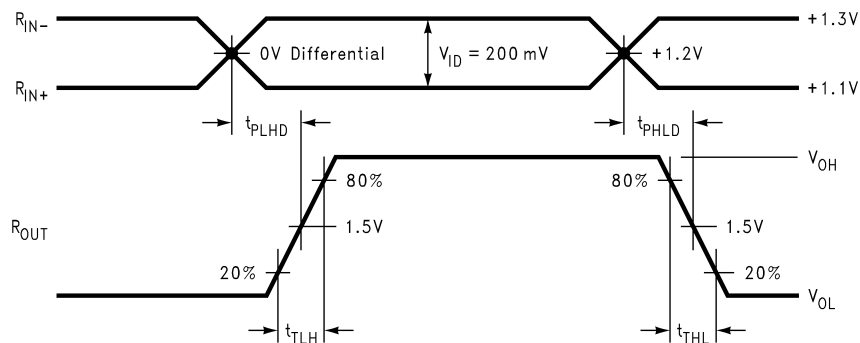
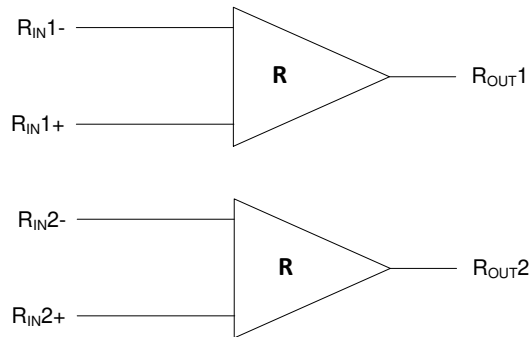

Figure 16. Receiver Propagation Delay and Transition Time Waveforms

8 Detailed Description

8.1 Functional Block Diagram



8.2 Device Functional Modes

Table 1. Truth Table

INPUTS	OUTPUT
$[R_{IN+}] - [R_{IN-}]$	R_{OUT}
$V_{ID} \geq 0.1V$	H
$V_{ID} \leq -0.1V$	L
$-0.1V \leq V_{ID} \leq 0.1V$? ⁽¹⁾

(1) ? indicates state is indeterminate

9 Application and Implementation

NOTE

Information in the following applications sections is not part of the TI component specification, and TI does not warrant its accuracy or completeness. TI's customers are responsible for determining suitability of components for their purposes. Customers should validate and test their design implementation to confirm system functionality.

9.1 Application Information

General application guidelines and hints for LVDS drivers and receivers may be found in the following application notes: LVDS Owner's Manual at www.ti.com.

LVDS drivers and receivers are intended to be primarily used in a simple point-to-point configuration as is shown in Figure 17. This configuration provides a clean signaling environment for the fast edge rates of the drivers. The receiver is connected to the driver through a balanced media which may be a standard twisted pair cable, a parallel pair cable, or simply PCB traces. Typically the characteristic impedance of the media is in the range of 100Ω. A termination resistor of 100Ω should be used, and is located as close to the receiver input pins as possible. The termination resistor converts the driver output (current mode) into a voltage that is detected by the receiver. Other configurations are possible such as a multi-receiver configuration, but the effects of a mid-stream connector(s), cable stub(s), and other impedance discontinuities as well as ground shifting, noise margin limits, and total termination loading must be taken into account.

The DS90LV028AQ differential line receiver is capable of detecting signals as low as 100 mV, over a ±1V common-mode range centered around +1.2V. This is related to the driver offset voltage which is typically +1.2V. The driven signal is centered around this voltage and may shift ±1V around this center point. The ±1V shifting may be the result of a ground potential difference between the driver's ground reference and the receiver's ground reference, the common-mode effects of coupled noise, or a combination of the two. The AC parameters of both receiver input pins are optimized for a recommended operating input voltage range of 0V to +2.4V (measured from each pin to ground). The device will operate for receiver input voltages up to V_{CC}, but exceeding V_{CC} will turn on the ESD protection circuitry which will clamp the bus voltages.

9.2 Typical Application

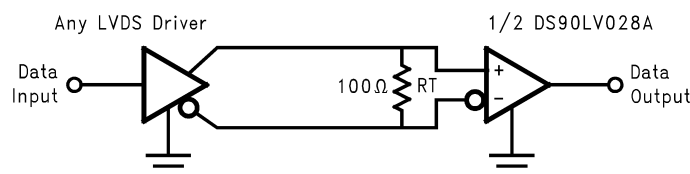

Figure 17. Balanced System Point-to-Point Application

9.2.1 Detailed Design Procedure

9.2.1.1 Power Decoupling Recommendations

Bypass capacitors must be used on power pins. Use high frequency ceramic (surface mount is recommended) 0.1 μF and 0.01 μF capacitors in parallel at the power supply pin with the smallest value capacitor closest to the device supply pin. Additional scattered capacitors over the printed circuit board will improve decoupling. Multiple vias should be used to connect the decoupling capacitors to the power planes. A 10 μF (35 V) or greater solid tantalum capacitor should be connected at the power entry point on the printed circuit board between the supply and ground.

9.2.1.2 Termination

Use a termination resistor which best matches the differential impedance or your transmission line. The resistor should be between 90 Ω and 130 Ω. Remember that the current mode outputs need the termination resistor to generate the differential voltage. LVDS will not work correctly without resistor termination. Typically, connecting a single resistor across the pair at the receiver end will suffice.

Typical Application (continued)

Surface mount 1% - 2% resistors are the best. PCB stubs, component lead, and the distance from the termination to the receiver inputs should be minimized. The distance between the termination resistor and the receiver should be < 10 mm (12 mm MAX).

9.2.1.3 Input Failsafe Biasing

External pull up and pull down resistors may be used to provide enough of an offset to enable an input failsafe under open-circuit conditions. This configuration ties the positive LVDS input pin to VDD thru a pull up resistor and the negative LVDS input pin is tied to GND by a pull down resistor. The pull up and pull down resistors should be in the 5 k Ω to 15 k Ω range to minimize loading and waveform distortion to the driver. The common-mode bias point ideally should be set to approximately 1.2 V (less than 1.75 V) to be compatible with the internal circuitry. Please refer to application note AN-1194, "Failsafe Biasing of LVDS Interfaces" ([SNLA051](#)) for more information.

9.2.1.4 Probing LVDS Transmission Lines

Always use high impedance (> 100 k Ω), low capacitance (< 2 pF) scope probes with a wide bandwidth (1 GHz) scope. Improper probing will give deceiving results.

9.2.1.5 Cables and Connectors, General Comments

When choosing cable and connectors for LVDS it is important to remember:

Use controlled impedance media. The cables and connectors you use should have a matched differential impedance of about 100 Ω . They should not introduce major impedance discontinuities.

Balanced cables (e.g. twisted pair) are usually better than unbalanced cables (ribbon cable, simple coax) for noise reduction and signal quality. Balanced cables tend to generate less EMI due to field canceling effects and also tend to pick up electromagnetic radiation a common-mode (not differential mode) noise which is rejected by the receiver.

For cable distances < 0.5 M, most cables can be made to work effectively. For distances $0.5 \text{ M} \leq d \leq 10 \text{ M}$, CAT 3 (category 3) twisted pair cable works well, is readily available and relatively inexpensive.

10 Layout

10.1 Layout Guidelines

10.1.1 Differential Traces

Use controlled impedance traces which match the differential impedance of your transmission medium (ie. cable) and termination resistor. Run the differential pair trace lines as close together as possible as soon as they leave the IC (stubs should be < 10mm long). This will help eliminate reflections and ensure noise is coupled as common-mode. In fact, we have seen that differential signals which are 1mm apart radiate far less noise than traces 3mm apart since magnetic field cancellation is much better with the closer traces. In addition, noise induced on the differential lines is much more likely to appear as common-mode which is rejected by the receiver.

Match electrical lengths between traces to reduce skew. Skew between the signals of a pair means a phase difference between signals which destroys the magnetic field cancellation benefits of differential signals and EMI will result! (Note that the velocity of propagation, $v = c/E_r$, where c (the speed of light) = 0.2997 mm/ps or 0.0118 in/ps). Do not rely solely on the autoroute function for differential traces. Carefully review dimensions to match differential impedance and provide isolation for the differential lines. Minimize the number of vias and other discontinuities on the line.

Avoid 90° turns (these cause impedance discontinuities). Use arcs or 45° bevels.

Within a pair of traces, the distance between the two traces should be minimized to maintain common-mode rejection of the receivers. On the printed circuit board, this distance should remain constant to avoid discontinuities in differential impedance. Minor violations at connection points are allowable.

10.1.2 PC Board Considerations

Use at least 4 PCB board layers (top to bottom): LVDS signals, ground, power, TTL signals.

Isolate TTL signals from LVDS signals, otherwise the TTL signals may couple onto the LVDS lines. It is best to put TTL and LVDS signals on different layers which are isolated by a power/ground plane(s).

Keep drivers and receivers as close to the (LVDS port side) connectors as possible.

11 Device and Documentation Support

11.1 Device Support

11.2 Community Resources

TI E2E™ support forums are an engineer's go-to source for fast, verified answers and design help — straight from the experts. Search existing answers or ask your own question to get the quick design help you need.

Linked content is provided "AS IS" by the respective contributors. They do not constitute TI specifications and do not necessarily reflect TI's views; see TI's [Terms of Use](#).

11.3 Trademarks

E2E is a trademark of Texas Instruments.
All other trademarks are the property of their respective owners.

11.4 Electrostatic Discharge Caution



This integrated circuit can be damaged by ESD. Texas Instruments recommends that all integrated circuits be handled with appropriate precautions. Failure to observe proper handling and installation procedures can cause damage.

ESD damage can range from subtle performance degradation to complete device failure. Precision integrated circuits may be more susceptible to damage because very small parametric changes could cause the device not to meet its published specifications.

11.5 Glossary



[SLYZ022](#) — *TI Glossary*.

This glossary lists and explains terms, acronyms, and definitions.

12 Mechanical, Packaging, and Orderable Information

The following pages include mechanical, packaging, and orderable information. This information is the most current data available for the designated devices. This data is subject to change without notice and revision of this document. For browser-based versions of this data sheet, refer to the left-hand navigation.

PACKAGING INFORMATION

Orderable Device	Status (1)	Package Type	Package Drawing	Pins	Package Qty	Eco Plan (2)	Lead finish/ Ball material (6)	MSL Peak Temp (3)	Op Temp (°C)	Device Marking (4/5)	Samples
DS90LV028AQMA/NOPB	ACTIVE	SOIC	D	8	95	RoHS & Green	SN	Level-1-260C-UNLIM	-40 to 125	90LV0 28AQM	
DS90LV028AQMAX/NOPB	ACTIVE	SOIC	D	8	2500	RoHS & Green	SN	Level-1-260C-UNLIM	-40 to 125	90LV0 28AQM	

(1) The marketing status values are defined as follows:

ACTIVE: Product device recommended for new designs.

LIFEBUY: TI has announced that the device will be discontinued, and a lifetime-buy period is in effect.

NRND: Not recommended for new designs. Device is in production to support existing customers, but TI does not recommend using this part in a new design.

PREVIEW: Device has been announced but is not in production. Samples may or may not be available.

OBSOLETE: TI has discontinued the production of the device.

(2) **RoHS:** TI defines "RoHS" to mean semiconductor products that are compliant with the current EU RoHS requirements for all 10 RoHS substances, including the requirement that RoHS substance do not exceed 0.1% by weight in homogeneous materials. Where designed to be soldered at high temperatures, "RoHS" products are suitable for use in specified lead-free processes. TI may reference these types of products as "Pb-Free".

RoHS Exempt: TI defines "RoHS Exempt" to mean products that contain lead but are compliant with EU RoHS pursuant to a specific EU RoHS exemption.

Green: TI defines "Green" to mean the content of Chlorine (Cl) and Bromine (Br) based flame retardants meet JS709B low halogen requirements of <=1000ppm threshold. Antimony trioxide based flame retardants must also meet the <=1000ppm threshold requirement.

(3) MSL, Peak Temp. - The Moisture Sensitivity Level rating according to the JEDEC industry standard classifications, and peak solder temperature.

(4) There may be additional marking, which relates to the logo, the lot trace code information, or the environmental category on the device.

(5) Multiple Device Markings will be inside parentheses. Only one Device Marking contained in parentheses and separated by a "~" will appear on a device. If a line is indented then it is a continuation of the previous line and the two combined represent the entire Device Marking for that device.

(6) Lead finish/Ball material - Orderable Devices may have multiple material finish options. Finish options are separated by a vertical ruled line. Lead finish/Ball material values may wrap to two lines if the finish value exceeds the maximum column width.

Important Information and Disclaimer:The information provided on this page represents TI's knowledge and belief as of the date that it is provided. TI bases its knowledge and belief on information provided by third parties, and makes no representation or warranty as to the accuracy of such information. Efforts are underway to better integrate information from third parties. TI has taken and continues to take reasonable steps to provide representative and accurate information but may not have conducted destructive testing or chemical analysis on incoming materials and chemicals. TI and TI suppliers consider certain information to be proprietary, and thus CAS numbers and other limited information may not be available for release.

In no event shall TI's liability arising out of such information exceed the total purchase price of the TI part(s) at issue in this document sold by TI to Customer on an annual basis.

TAPE AND REEL INFORMATION

QUADRANT ASSIGNMENTS FOR PIN 1 ORIENTATION IN TAPE

*All dimensions are nominal

Device	Package Type	Package Drawing	Pins	SPQ	Reel Diameter (mm)	Reel Width W1 (mm)	A0 (mm)	B0 (mm)	K0 (mm)	P1 (mm)	W (mm)	Pin1 Quadrant
DS90LV028AQM/NOPB	SOIC	D	8	2500	330.0	12.4	6.5	5.4	2.0	8.0	12.0	Q1

TAPE AND REEL BOX DIMENSIONS

*All dimensions are nominal

Device	Package Type	Package Drawing	Pins	SPQ	Length (mm)	Width (mm)	Height (mm)
DS90LV028AQMAX/NOPB	SOIC	D	8	2500	367.0	367.0	35.0

TUBE

*All dimensions are nominal

Device	Package Name	Package Type	Pins	SPQ	L (mm)	W (mm)	T (μm)	B (mm)
DS90LV028AQMA/NOPB	D	SOIC	8	95	495	8	4064	3.05



D0008A

PACKAGE OUTLINE

SOIC - 1.75 mm max height

SMALL OUTLINE INTEGRATED CIRCUIT



4214825/C 02/2019

NOTES:

- Linear dimensions are in inches [millimeters]. Dimensions in parenthesis are for reference only. Controlling dimensions are in inches. Dimensioning and tolerancing per ASME Y14.5M.
- This drawing is subject to change without notice.
- This dimension does not include mold flash, protrusions, or gate burrs. Mold flash, protrusions, or gate burrs shall not exceed $.006$ [0.15] per side.
- This dimension does not include interlead flash.
- Reference JEDEC registration MS-012, variation AA.

EXAMPLE BOARD LAYOUT

D0008A

SOIC - 1.75 mm max height

SMALL OUTLINE INTEGRATED CIRCUIT



LAND PATTERN EXAMPLE
 EXPOSED METAL SHOWN
 SCALE:8X



SOLDER MASK DETAILS

4214825/C 02/2019

NOTES: (continued)

- 6. Publication IPC-7351 may have alternate designs.
- 7. Solder mask tolerances between and around signal pads can vary based on board fabrication site.

EXAMPLE STENCIL DESIGN

D0008A

SOIC - 1.75 mm max height

SMALL OUTLINE INTEGRATED CIRCUIT



SOLDER PASTE EXAMPLE
BASED ON .005 INCH [0.125 MM] THICK STENCIL
SCALE:8X

4214825/C 02/2019

NOTES: (continued)

8. Laser cutting apertures with trapezoidal walls and rounded corners may offer better paste release. IPC-7525 may have alternate design recommendations.
9. Board assembly site may have different recommendations for stencil design.

IMPORTANT NOTICE AND DISCLAIMER

TI PROVIDES TECHNICAL AND RELIABILITY DATA (INCLUDING DATA SHEETS), DESIGN RESOURCES (INCLUDING REFERENCE DESIGNS), APPLICATION OR OTHER DESIGN ADVICE, WEB TOOLS, SAFETY INFORMATION, AND OTHER RESOURCES "AS IS" AND WITH ALL FAULTS, AND DISCLAIMS ALL WARRANTIES, EXPRESS AND IMPLIED, INCLUDING WITHOUT LIMITATION ANY IMPLIED WARRANTIES OF MERCHANTABILITY, FITNESS FOR A PARTICULAR PURPOSE OR NON-INFRINGEMENT OF THIRD PARTY INTELLECTUAL PROPERTY RIGHTS.

These resources are intended for skilled developers designing with TI products. You are solely responsible for (1) selecting the appropriate TI products for your application, (2) designing, validating and testing your application, and (3) ensuring your application meets applicable standards, and any other safety, security, regulatory or other requirements.

These resources are subject to change without notice. TI grants you permission to use these resources only for development of an application that uses the TI products described in the resource. Other reproduction and display of these resources is prohibited. No license is granted to any other TI intellectual property right or to any third party intellectual property right. TI disclaims responsibility for, and you will fully indemnify TI and its representatives against, any claims, damages, costs, losses, and liabilities arising out of your use of these resources.

TI's products are provided subject to [TI's Terms of Sale](#) or other applicable terms available either on ti.com or provided in conjunction with such TI products. TI's provision of these resources does not expand or otherwise alter TI's applicable warranties or warranty disclaimers for TI products.

TI objects to and rejects any additional or different terms you may have proposed.

Mailing Address: Texas Instruments, Post Office Box 655303, Dallas, Texas 75265
Copyright © 2022, Texas Instruments Incorporated