

MC14503B

Hex Non-Inverting 3-State Buffer

The MC14503B is a hex non-inverting buffer with 3-state outputs, and a high current source and sink capability. The 3-state outputs make it useful in common bussing applications. Two disable controls are provided. A high level on the Disable A input causes the outputs of buffers 1 through 4 to go into a high impedance state and a high level on the Disable B input causes the outputs of buffers 5 and 6 to go into a high impedance state.

Features

- 3-State Outputs
- TTL Compatible – Will Drive One TTL Load Over Full Temperature Range
- Supply Voltage Range = 3.0 Vdc to 18 Vdc
- Two Disable Controls for Added Versatility
- Pin for Pin Replacement for MM80C97 and 340097
- NLV Prefix for Automotive and Other Applications Requiring Unique Site and Control Change Requirements; AEC-Q100 Qualified and PPAP Capable
- This Device is Pb-Free and is RoHS Compliant

MAXIMUM RATINGS (Voltages Referenced to V_{SS}) (Note 1)

Parameter	Symbol	Value	Unit
DC Supply Voltage Range	V_{DD}	-0.5 to +18.0	V
Input or Output Voltage Range (DC or Transient)	V_{in}, V_{out}	-0.5 to V_{DD} + 0.5	V
Input Current (DC or Transient) per Pin	I_{in}	± 10	mA
Output Current (DC or Transient) per Pin	I_{out}	± 25	mA
Power Dissipation, per Package (Note 2)	P_D	500	mW
Ambient Temperature Range	T_A	-55 to +125	$^{\circ}C$
Storage Temperature Range		-65 to +150	$^{\circ}C$
Lead Temperature (8-Second Soldering)		260	$^{\circ}C$

Stresses exceeding those listed in the Maximum Ratings table may damage the device. If any of these limits are exceeded, device functionality should not be assumed, damage may occur and reliability may be affected.

1. Maximum Ratings are those values beyond which damage to the device may occur.
2. Temperature Derating:
"D/DW" Package: -7.0 mW/ $^{\circ}C$ From 65 $^{\circ}C$ To 125 $^{\circ}C$

This device contains protection circuitry to guard against damage due to high static voltages or electric fields. However, precautions must be taken to avoid applications of any voltage higher than maximum rated voltages to this high-impedance circuit. For proper operation, V_{in} and V_{out} should be constrained to the range $V_{SS} \leq (V_{in} \text{ or } V_{out}) \leq V_{DD}$.

Unused inputs must always be tied to an appropriate logic voltage level (e.g., either V_{SS} or V_{DD}). Unused outputs must be left open.



ON Semiconductor®

<http://onsemi.com>

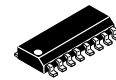

1
SOIC-16
D SUFFIX
CASE 751B

PIN ASSIGNMENT

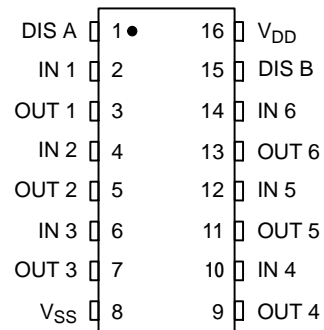

MARKING DIAGRAM

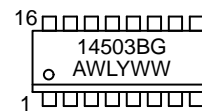

A = Assembly Location
WL, L = Wafer Lot
YY, Y = Year
WW, W = Work Week
G = Pb-Free Package

TRUTH TABLE

In_n	Appropriate Disable Input	Out_n
0	0	0
1	0	1
X	1	High Impedance

X = Don't Care

ORDERING INFORMATION

See detailed ordering and shipping information in the package dimensions section on page 4 of this data sheet.

MC14503B

LOGIC DIAGRAM

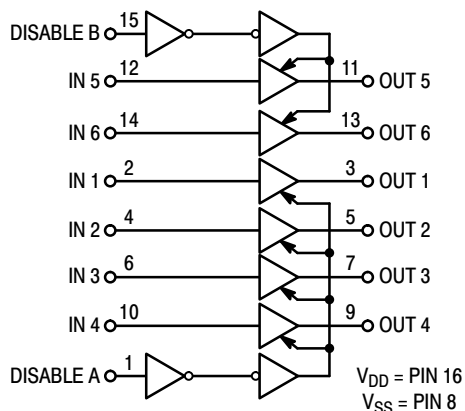

CIRCUIT DIAGRAM

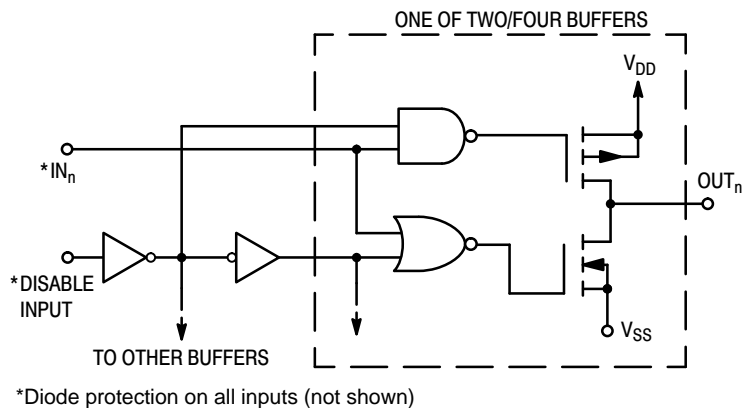

ELECTRICAL CHARACTERISTICS (Voltages Referenced to V_{SS})

Characteristic	Symbol	V _{DD} Vdc	- 55°C		25°C			125°C		Unit
			Min	Max	Min	Typ (Note 3)	Max	Min	Max	
Output Voltage V _{in} = 0	"0" Level V _{OL}	5.0	-	0.05	-	0	0.05	-	0.05	Vdc
		10	-	0.05	-	0	0.05	-	0.05	
		15	-	0.05	-	0	0.05	-	0.05	
V _{in} = V _{DD}	"1" Level V _{OH}	5.0	4.95	-	4.95	5.0	-	4.95	-	Vdc
		10	9.95	-	9.95	10	-	9.95	-	
		15	14.95	-	14.95	15	-	14.95	-	
Input Voltage (V _O = 3.6 or 1.4 Vdc) (V _O = 7.2 or 2.8 Vdc) (V _O = 11.5 or 3.5 Vdc)	"0" Level V _{IL}	5.0	-	1.5	-	2.25	1.5	-	1.5	Vdc
		10	-	3.0	-	4.50	3.0	-	3.0	
		15	-	4.0	-	6.75	4.0	-	4.0	
	"1" Level V _{IH}	5.0	3.5	-	3.5	2.75	-	3.5	-	Vdc
		10	7.0	-	7.0	5.50	-	7.0	-	
		15	11	-	11	8.25	-	11	-	
Output Drive Current (V _{OH} = 2.5 Vdc) (V _{OH} = 2.5 Vdc) (V _{OH} = 4.6 Vdc) (V _{OH} = 9.5 Vdc) (V _{OH} = 13.5 Vdc)	Source I _{OH}	4.5	-4.3	-	-3.6	-5.0	-	-2.5	-	mAdc
		5.0	-5.8	-	-4.8	-6.1	-	-3.0	-	
		5.0	-1.2	-	-1.02	-1.4	-	-0.7	-	
		10	-3.1	-	-2.6	-3.7	-	-1.8	-	
		15	-8.2	-	-6.8	-14.1	-	-4.8	-	
	Sink I _{OL}	4.5	2.2	-	1.8	2.1	-	1.2	-	mAdc
		5.0	2.6	-	2.1	2.3	-	1.3	-	
		10	6.5	-	5.5	6.2	-	3.8	-	
		15	19.2	-	16.1	25	-	11.2	-	
		Input Current	I _{in}	15	-	±0.1	-	±0.00001	±0.1	
Input Capacitance, (V _{in} = 0)	C _{in}	-	-	-	-	5.0	7.5	-	-	pF
Quiescent Current, (Per Package)	I _Q	5.0	-	1.0	-	0.002	1.0	-	30	μAdc
		10	-	2.0	-	0.004	2.0	-	60	
		15	-	4.0	-	0.006	4.0	-	120	
Total Supply Current (Note 4, 5) (Dynamic plus Quiescent, Per Package) (C _L = 50 pF on all outputs) (All outputs switching, 50% Duty Cycle)	I _T	5.0	I _T = (2.5 μA/kHz) f + I _{DD}							μAdc
		10	I _T = (6.0 μA/kHz) f + I _{DD}							
		15	I _T = (10 μA/kHz) f + I _{DD}							
3-State Output Leakage Current	I _{TL}	15	-	±0.1	-	±0.0001	±0.1	-	±3.0	μAdc

Product parametric performance is indicated in the Electrical Characteristics for the listed test conditions, unless otherwise noted. Product performance may not be indicated by the Electrical Characteristics if operated under different conditions.

3. Data labelled "Typ" is not to be used for design purposes but is intended as an indication of the IC's potential performance.

4. The formulas given are for the typical characteristics only at 25°C.

5. To calculate total supply current at loads other than 50 pF: I_T(C_L) = I_T(50 pF) + (C_L - 50) Vfk where: I_T is in μA (per package), C_L in pF, V = (V_{DD} - V_{SS}) in volts, f in kHz is input frequency, and k = 0.006.

MC14503B

SWITCHING CHARACTERISTICS (Note 6) ($C_L = 50 \text{ pF}$, $T_A = 25^\circ\text{C}$)

Characteristic	Symbol	V_{DD} V_{CC}	All Types		Unit
			Typ (Note 7)	Max	
Output Rise Time $t_{TLH} = (0.5 \text{ ns/pF}) C_L + 20 \text{ ns}$ $t_{TLH} = (0.3 \text{ ns/pF}) C_L + 8.0 \text{ ns}$ $t_{TLH} = (0.2 \text{ ns/pF}) C_L + 8.0 \text{ ns}$	t_{TLH}	5.0 10 15	45 23 18	90 45 35	ns
Output Fall Time $t_{THL} = (0.5 \text{ ns/pF}) C_L + 20 \text{ ns}$ $t_{THL} = (0.3 \text{ ns/pF}) C_L + 8.0 \text{ ns}$ $t_{THL} = (0.2 \text{ ns/pF}) C_L + 8.0 \text{ ns}$	t_{THL}	5.0 10 15	45 23 18	90 45 35	ns
Turn-Off Delay Time, all Outputs $t_{PLH} = (0.3 \text{ ns/pF}) C_L + 60 \text{ ns}$ $t_{PLH} = (0.15 \text{ ns/pF}) C_L + 27 \text{ ns}$ $t_{PLH} = (0.1 \text{ ns/pF}) C_L + 20 \text{ ns}$	t_{PLH}	5.0 10 15	75 35 25	150 70 50	ns
Turn-On Delay Time, all Outputs $t_{PHL} = (0.3 \text{ ns/pF}) C_L + 60 \text{ ns}$ $t_{PHL} = (0.15 \text{ ns/pF}) C_L + 27 \text{ ns}$ $t_{PHL} = (0.1 \text{ ns/pF}) C_L + 20 \text{ ns}$	t_{PHL}	5.0 10 15	75 35 25	150 70 50	ns
3-State Propagation Delay Time Output "1" to High Impedance	t_{PHZ}	5.0 10 15	75 40 35	150 80 70	ns
Output "0" to High Impedance	t_{PLZ}	5.0 10 15	80 40 35	160 80 70	ns
High Impedance to "1" Level	t_{PZH}	5.0 10 15	65 25 20	130 50 40	ns
High Impedance to "0" Level	t_{PZL}	5.0 10 15	100 35 25	200 70 50	ns

6. The formulas given are for the typical characteristics only at 25°C.

7. Data labelled "Typ" is not to be used for design purposes but is intended as an indication of the IC's potential performance.

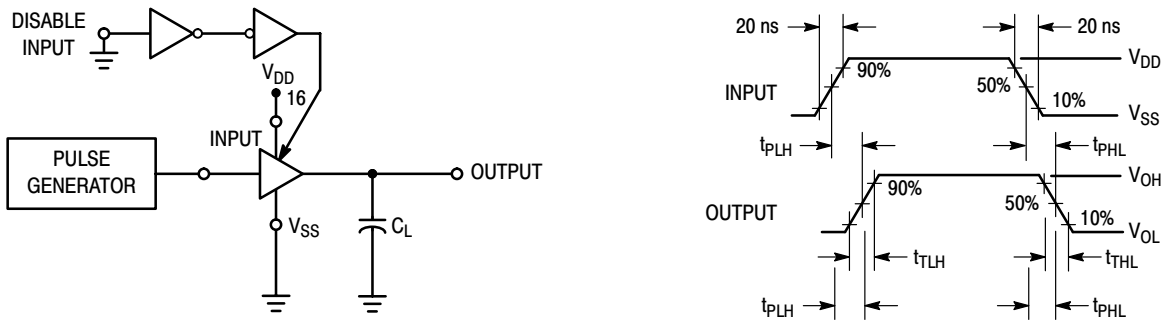
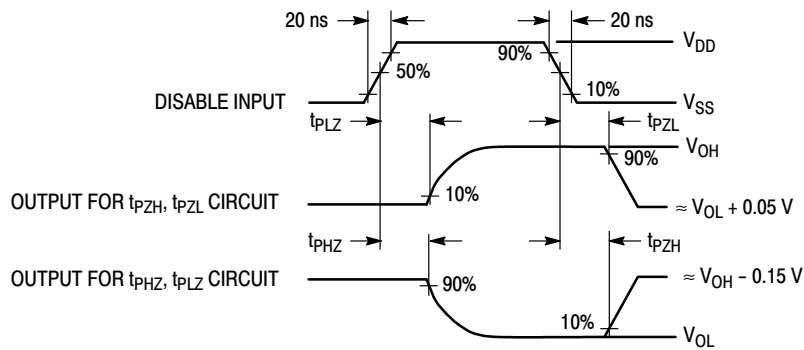
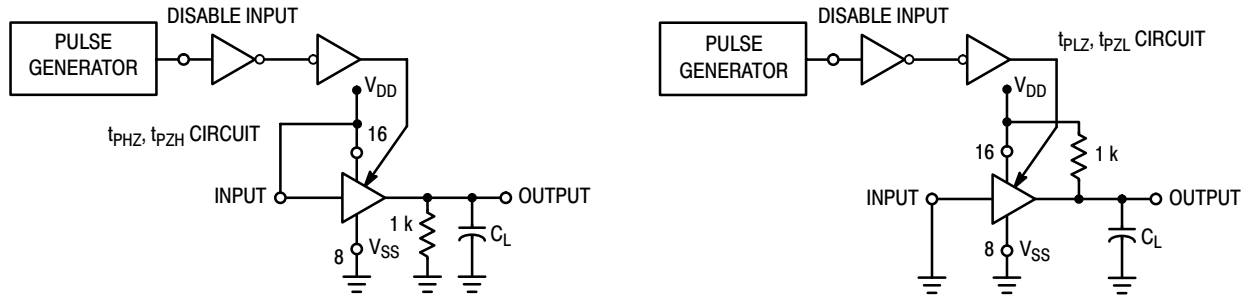

Figure 1. Switching Time Test Circuit and Waveforms (t_{TLH} , t_{THL} , t_{PHL} , and t_{PLH})

MC14503B



**Figure 2. 3–State AC Test Circuit and Waveforms
(t_{PLZ} , t_{PHZ} , t_{PZH} , t_{PZL})**

ORDERING INFORMATION

Device	Package	Shipping†
MC14503BDG	SOIC–16 (Pb–Free)	48 / Rail
MC14503BDR2G	SOIC–16 (Pb–Free)	2500 / Tape & Reel
NLV14503BDR2G*	SOIC–16 (Pb–Free)	2500 / Tape & Reel

†For information on tape and reel specifications, including part orientation and tape sizes, please refer to our Tape and Reel Packaging Specifications Brochure, BRD8011/D.

*NLV Prefix for Automotive and Other Applications Requiring Unique Site and Control Change Requirements; AEC–Q100 Qualified and PPAP Capable.

MECHANICAL CASE OUTLINE PACKAGE DIMENSIONS

ON Semiconductor®



SCALE 1:1

SOIC-16 CASE 751B-05 ISSUE K

DATE 29 DEC 2006



NOTES:

1. DIMENSIONING AND TOLERANCING PER ANSI Y14.5M, 1982.
2. CONTROLLING DIMENSION: MILLIMETER.
3. DIMENSIONS A AND B DO NOT INCLUDE MOLD PROTRUSION.
4. MAXIMUM MOLD PROTRUSION 0.15 (0.006) PER SIDE.
5. DIMENSION D DOES NOT INCLUDE DAMBAR PROTRUSION. ALLOWABLE DAMBAR PROTRUSION SHALL BE 0.127 (0.005) TOTAL IN EXCESS OF THE D DIMENSION AT MAXIMUM MATERIAL CONDITION.

DIM	MILLIMETERS		INCHES	
	MIN	MAX	MIN	MAX
A	9.80	10.00	0.386	0.393
B	3.80	4.00	0.150	0.157
C	1.35	1.75	0.054	0.068
D	0.35	0.49	0.014	0.019
F	0.40	1.25	0.016	0.049
G	1.27 BSC		0.050 BSC	
J	0.19	0.25	0.008	0.009
K	0.10	0.25	0.004	0.009
M	0°	7°	0°	7°
P	5.80	6.20	0.229	0.244
R	0.25	0.50	0.010	0.019

- | | | | |
|--|--|--|--|
| <p>STYLE 1:</p> <p>PIN 1. COLLECTOR</p> <p>2. BASE</p> <p>3. EMITTER</p> <p>4. NO CONNECTION</p> <p>5. EMITTER</p> <p>6. BASE</p> <p>7. COLLECTOR</p> <p>8. COLLECTOR</p> <p>9. BASE</p> <p>10. EMITTER</p> <p>11. NO CONNECTION</p> <p>12. EMITTER</p> <p>13. BASE</p> <p>14. COLLECTOR</p> <p>15. EMITTER</p> <p>16. COLLECTOR</p> | <p>STYLE 2:</p> <p>PIN 1. CATHODE</p> <p>2. ANODE</p> <p>3. NO CONNECTION</p> <p>4. CATHODE</p> <p>5. CATHODE</p> <p>6. NO CONNECTION</p> <p>7. ANODE</p> <p>8. CATHODE</p> <p>9. CATHODE</p> <p>10. ANODE</p> <p>11. NO CONNECTION</p> <p>12. CATHODE</p> <p>13. CATHODE</p> <p>14. NO CONNECTION</p> <p>15. ANODE</p> <p>16. CATHODE</p> | <p>STYLE 3:</p> <p>PIN 1. COLLECTOR, DYE #1</p> <p>2. BASE, #1</p> <p>3. EMITTER, #1</p> <p>4. COLLECTOR, #1</p> <p>5. COLLECTOR, #2</p> <p>6. BASE, #2</p> <p>7. EMITTER, #2</p> <p>8. COLLECTOR, #2</p> <p>9. COLLECTOR, #3</p> <p>10. BASE, #3</p> <p>11. EMITTER, #3</p> <p>12. COLLECTOR, #3</p> <p>13. COLLECTOR, #4</p> <p>14. BASE, #4</p> <p>15. EMITTER, #4</p> <p>16. COLLECTOR, #4</p> | <p>STYLE 4:</p> <p>PIN 1. COLLECTOR, DYE #1</p> <p>2. COLLECTOR, #1</p> <p>3. COLLECTOR, #2</p> <p>4. COLLECTOR, #2</p> <p>5. COLLECTOR, #3</p> <p>6. COLLECTOR, #3</p> <p>7. COLLECTOR, #4</p> <p>8. COLLECTOR, #4</p> <p>9. BASE, #4</p> <p>10. EMITTER, #4</p> <p>11. BASE, #3</p> <p>12. EMITTER, #3</p> <p>13. BASE, #2</p> <p>14. EMITTER, #2</p> <p>15. BASE, #1</p> <p>16. EMITTER, #1</p> |
| <p>STYLE 5:</p> <p>PIN 1. DRAIN, DYE #1</p> <p>2. DRAIN, #1</p> <p>3. DRAIN, #2</p> <p>4. DRAIN, #2</p> <p>5. DRAIN, #3</p> <p>6. DRAIN, #3</p> <p>7. DRAIN, #4</p> <p>8. DRAIN, #4</p> <p>9. GATE, #4</p> <p>10. SOURCE, #4</p> <p>11. GATE, #3</p> <p>12. SOURCE, #3</p> <p>13. GATE, #2</p> <p>14. SOURCE, #2</p> <p>15. GATE, #1</p> <p>16. SOURCE, #1</p> | <p>STYLE 6:</p> <p>PIN 1. CATHODE</p> <p>2. CATHODE</p> <p>3. CATHODE</p> <p>4. CATHODE</p> <p>5. CATHODE</p> <p>6. CATHODE</p> <p>7. CATHODE</p> <p>8. CATHODE</p> <p>9. ANODE</p> <p>10. ANODE</p> <p>11. ANODE</p> <p>12. ANODE</p> <p>13. ANODE</p> <p>14. ANODE</p> <p>15. ANODE</p> <p>16. ANODE</p> | <p>STYLE 7:</p> <p>PIN 1. SOURCE N-CH</p> <p>2. COMMON DRAIN (OUTPUT)</p> <p>3. COMMON DRAIN (OUTPUT)</p> <p>4. GATE P-CH</p> <p>5. COMMON DRAIN (OUTPUT)</p> <p>6. COMMON DRAIN (OUTPUT)</p> <p>7. COMMON DRAIN (OUTPUT)</p> <p>8. SOURCE P-CH</p> <p>9. SOURCE P-CH</p> <p>10. COMMON DRAIN (OUTPUT)</p> <p>11. COMMON DRAIN (OUTPUT)</p> <p>12. COMMON DRAIN (OUTPUT)</p> <p>13. GATE N-CH</p> <p>14. COMMON DRAIN (OUTPUT)</p> <p>15. COMMON DRAIN (OUTPUT)</p> <p>16. SOURCE N-CH</p> | |

SOLDERING FOOTPRINT

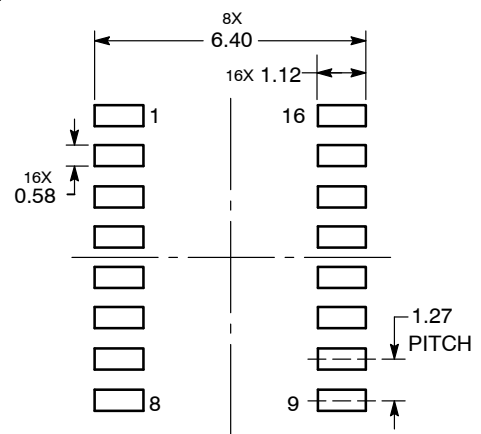

DOCUMENT NUMBER:	98ASB42566B	Electronic versions are uncontrolled except when accessed directly from the Document Repository. Printed versions are uncontrolled except when stamped "CONTROLLED COPY" in red.
DESCRIPTION:	SOIC-16	PAGE 1 OF 1

ON Semiconductor and ON are trademarks of Semiconductor Components Industries, LLC dba ON Semiconductor or its subsidiaries in the United States and/or other countries. ON Semiconductor reserves the right to make changes without further notice to any products herein. ON Semiconductor makes no warranty, representation or guarantee regarding the suitability of its products for any particular purpose, nor does ON Semiconductor assume any liability arising out of the application or use of any product or circuit, and specifically disclaims any and all liability, including without limitation special, consequential or incidental damages. ON Semiconductor does not convey any license under its patent rights nor the rights of others.

onsemi, **Onsemi**, and other names, marks, and brands are registered and/or common law trademarks of Semiconductor Components Industries, LLC dba "**onsemi**" or its affiliates and/or subsidiaries in the United States and/or other countries. **onsemi** owns the rights to a number of patents, trademarks, copyrights, trade secrets, and other intellectual property. A listing of **onsemi**'s product/patent coverage may be accessed at www.onsemi.com/site/pdf/Patent-Marking.pdf. **onsemi** reserves the right to make changes at any time to any products or information herein, without notice. The information herein is provided "as-is" and **onsemi** makes no warranty, representation or guarantee regarding the accuracy of the information, product features, availability, functionality, or suitability of its products for any particular purpose, nor does **onsemi** assume any liability arising out of the application or use of any product or circuit, and specifically disclaims any and all liability, including without limitation special, consequential or incidental damages. Buyer is responsible for its products and applications using **onsemi** products, including compliance with all laws, regulations and safety requirements or standards, regardless of any support or applications information provided by **onsemi**. "Typical" parameters which may be provided in **onsemi** data sheets and/or specifications can and do vary in different applications and actual performance may vary over time. All operating parameters, including "Typicals" must be validated for each customer application by customer's technical experts. **onsemi** does not convey any license under any of its intellectual property rights nor the rights of others. **onsemi** products are not designed, intended, or authorized for use as a critical component in life support systems or any FDA Class 3 medical devices or medical devices with a same or similar classification in a foreign jurisdiction or any devices intended for implantation in the human body. Should Buyer purchase or use **onsemi** products for any such unintended or unauthorized application, Buyer shall indemnify and hold **onsemi** and its officers, employees, subsidiaries, affiliates, and distributors harmless against all claims, costs, damages, and expenses, and reasonable attorney fees arising out of, directly or indirectly, any claim of personal injury or death associated with such unintended or unauthorized use, even if such claim alleges that **onsemi** was negligent regarding the design or manufacture of the part. **onsemi** is an Equal Opportunity/Affirmative Action Employer. This literature is subject to all applicable copyright laws and is not for resale in any manner.

PUBLICATION ORDERING INFORMATION

LITERATURE FULFILLMENT:

Email Requests to: orderlit@onsemi.com

onsemi Website: www.onsemi.com

TECHNICAL SUPPORT

North American Technical Support:

Voice Mail: 1 800-282-9855 Toll Free USA/Canada

Phone: 011 421 33 790 2910

Europe, Middle East and Africa Technical Support:

Phone: 00421 33 790 2910

For additional information, please contact your local Sales Representative