

# INA290-Q1 AEC-Q100, 2.7-V to 120-V, 1.1-MHz, Ultra-Precise Current Sense Amplifier

## 1 Features

- AEC-Q100 qualified for automotive applications:
  - Temperature grade 1:  $-40^{\circ}\text{C}$  to  $+125^{\circ}\text{C}$ ,  $T_A$
- [Functional Safety-Capable](#)
  - [Documentation available to aid functional safety system design](#)
- Wide common-mode voltage:
  - Operational voltage: 2.7 V to 120 V
  - Survival voltage:  $-20\text{ V}$  to  $+122\text{ V}$
- Excellent CMRR:
  - 160-dB DC
  - 85-dB AC at 50 kHz
- Accuracy
  - Gain:
    - Gain error:  $\pm 0.1\%$  (maximum)
    - Gain drift:  $\pm 5\text{ ppm}/^{\circ}\text{C}$  (maximum)
  - Offset:
    - Offset voltage:  $\pm 12\text{ }\mu\text{V}$  (maximum)
    - Offset drift:  $\pm 0.2\text{ }\mu\text{V}/^{\circ}\text{C}$  (maximum)
- Available gains:
  - A1 devices: 20 V/V
  - A2 devices: 50 V/V
  - A3 devices: 100 V/V
  - A4 devices: 200 V/V
  - A5 devices: 500 V/V
- High bandwidth: 1.1 MHz
- Slew rate:  $2\text{ V}/\mu\text{s}$
- Quiescent current:  $370\text{ }\mu\text{A}$

## 2 Applications

- [Solid-state LiDAR](#)
- [Automotive HVAC compressor module](#)
- [Automotive interior heater module](#)
- [Automotive parking heater module](#)
- [Automotive Pumps](#)

## 3 Description

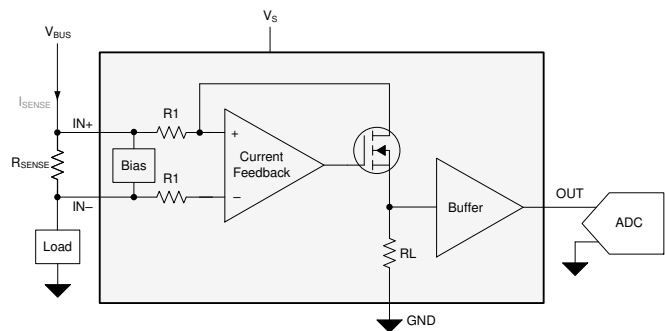
The INA290-Q1 is an ultra-precise current sense amplifier that can measure voltage drops across shunt resistors over a wide common-mode range from 2.7 V to 120 V. It is in a highly space-efficient SC-70 package with a PCB footprint of only  $2.0\text{ mm} \times 2.1\text{ mm}$ . The ultra-precise current measurement accuracy is achieved thanks to the combination of an ultra-low offset voltage of  $\pm 12\text{ }\mu\text{V}$  (maximum), a small gain error of  $\pm 0.1\%$  (maximum), and a high DC CMRR of 160 dB (typical). The INA290-Q1 is not only designed for DC current measurement, but also for high-speed applications (like fast overcurrent protection, for example) with a high bandwidth of 1.1 MHz (at gain of 20 V/V) and an 85-dB AC CMRR (at 50 kHz).

The INA290-Q1 provides the capability to make ultra-precise current measurements by sensing the voltage drop across a shunt resistor over a wide common-mode range from 2.7 V to 120 V. The INA290-Q1 is available in the SC-70 package minimizing solution size area.

### Device Information

PART NUMBER	PACKAGE <sup>(1)</sup>	BODY SIZE (NOM)
INA290-Q1	SC-70 (5)	$2.00\text{ mm} \times 1.25\text{ mm}$

- (1) For all available packages, see the package option addendum at the end of the data sheet.



**Typical Application**



## Table of Contents

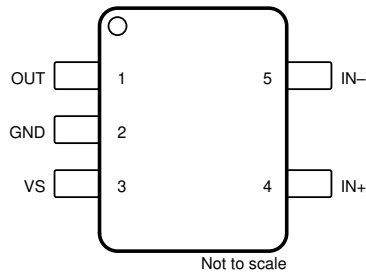
<b>1 Features</b> .....	<b>1</b>	<b>8 Application and Implementation</b> .....	<b>16</b>
<b>2 Applications</b> .....	<b>1</b>	8.1 Application Information.....	16
<b>3 Description</b> .....	<b>1</b>	8.2 Typical Application.....	18
<b>4 Revision History</b> .....	<b>2</b>	<b>9 Power Supply Recommendations</b> .....	<b>20</b>
<b>5 Pin Configuration and Functions</b> .....	<b>3</b>	<b>10 Layout</b> .....	<b>20</b>
<b>6 Specifications</b> .....	<b>4</b>	10.1 Layout Guidelines.....	20
6.1 Absolute Maximum Ratings .....	4	10.2 Layout Example.....	20
6.2 ESD Ratings .....	4	<b>11 Device and Documentation Support</b> .....	<b>21</b>
6.3 Recommended Operating Conditions .....	4	11.1 Documentation Support.....	21
6.4 Thermal Information .....	4	11.2 Receiving Notification of Documentation Updates..	21
6.5 Electrical Characteristics .....	5	11.3 Support Resources.....	21
6.6 Typical Characteristics.....	6	11.4 Trademarks.....	21
<b>7 Detailed Description</b> .....	<b>12</b>	11.5 Electrostatic Discharge Caution.....	21
7.1 Overview.....	12	11.6 Glossary.....	21
7.2 Functional Block Diagram.....	12	<b>12 Mechanical, Packaging, and Orderable Information</b> .....	<b>21</b>
7.3 Feature Description.....	13		
7.4 Device Functional Modes.....	15		

## 4 Revision History

NOTE: Page numbers for previous revisions may differ from page numbers in the current version.

<b>Changes from Revision * (October 2019) to Revision A (November 2020)</b>	<b>Page</b>
• Changed the data sheet status from Advanced Information to Production Data .....	1
• Updated the numbering format for tables, figures, and cross-references throughout the document .....	1

## 5 Pin Configuration and Functions



**Figure 5-1. DCK Package 5-Pin SC-70 Top View**

**Table 5-1. Pin Functions**

PIN		TYPE	DESCRIPTION
NAME	NO.		
GND	2	Ground	Ground
IN-	5	Input	Connect to load side of shunt resistor
IN+	4	Input	Connect to supply side of shunt resistor
OUT	1	Output	Output voltage
VS	3	Power	Power supply

## 6 Specifications

### 6.1 Absolute Maximum Ratings

over operating free-air temperature range (unless otherwise noted)<sup>(1)</sup>

		MIN	MAX	UNIT
V <sub>s</sub>	Supply Voltage	-0.3	22	V
Analog Inputs, V <sub>IN+</sub> , V <sub>IN-</sub> <sup>(2)</sup>	Differential (V <sub>IN+</sub> ) – (V <sub>IN-</sub> )	-30	30	V
	Common - mode	-20	122	V
Output		GND – 0.3	V <sub>s</sub> + 0.3	V
T <sub>A</sub>	Operating Temperature	-55	150	°C
T <sub>J</sub>	Junction temperature		150	°C
T <sub>stg</sub>	Storage temperature	-65	150	°C

- (1) Stresses beyond those listed under Absolute Maximum Ratings may cause permanent damage to the device. These are stress ratings only, which do not imply functional operation of the device at these or any other conditions beyond those indicated under Recommended Operating Conditions. Exposure to absolute-maximum-rated conditions for extended periods may affect device reliability.
- (2) V<sub>IN+</sub> and V<sub>IN-</sub> are the voltages at the V<sub>IN+</sub> and V<sub>IN-</sub> pins, respectively.

### 6.2 ESD Ratings

			VALUE	UNIT
V <sub>(ESD)</sub>	Electrostatic discharge	Human body model (HBM), per AEC Q100-002, all pins <sup>(1)</sup> HBM ESD Classification Level 2	±2000	V
		Charged device model (CDM), per AEC Q100-011, all pins CDM ESD Classification Level C6	±1000	

- (1) AEC Q100-002 indicates that HBM stressing shall be in accordance with the ANSI/ESDA/JEDEC JS-001 specification.

### 6.3 Recommended Operating Conditions

over operating free-air temperature range (unless otherwise noted)

		MIN	NOM	MAX	UNIT
V <sub>CM</sub>	Common-mode input range <sup>(1)</sup>	V <sub>s</sub>	48	120	V
V <sub>S</sub>	Operating supply range	2.7	5	20	V
T <sub>A</sub>	Ambient temperature	-40		125	°C

- (1) Common-mode voltage can go below V<sub>S</sub> under certain conditions. See [Figure 7-1](#) for additional information on operating range.

### 6.4 Thermal Information

THERMAL METRIC <sup>(1)</sup>		INA290-Q1	UNIT
		DCK (SC-70)	
		5 PINS	
R <sub>θJA</sub>	Junction-to-ambient thermal resistance	191.6	°C/W
R <sub>θJC(top)</sub>	Junction-to-case (top) thermal resistance	144.4	°C/W
R <sub>θJB</sub>	Junction-to-board thermal resistance	69.2	°C/W
Ψ <sub>JT</sub>	Junction-to-top characterization parameter	46.2	°C/W
Ψ <sub>JB</sub>	Junction-to-board characterization parameter	69.0	°C/W
R <sub>θJC(bot)</sub>	Junction-to-case (bottom) thermal resistance	N/A	°C/W

- (1) For more information about traditional and new thermal metrics, see the [Semiconductor and IC Package Thermal Metrics](#) application report.

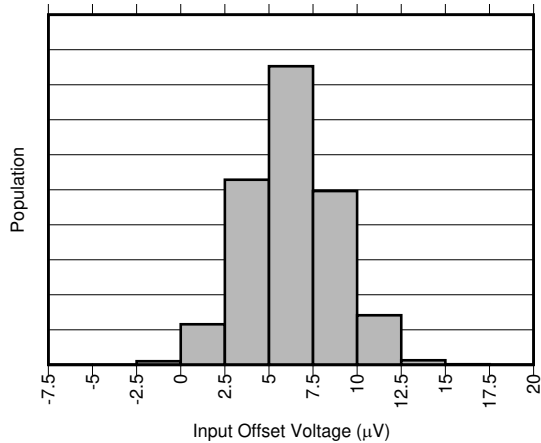
## 6.5 Electrical Characteristics

at  $T_A = 25\text{ }^\circ\text{C}$ ,  $V_S = 5\text{ V}$ ,  $V_{\text{SENSE}} = V_{\text{IN}+} - V_{\text{IN}-} = 0.5\text{ V} / \text{Gain}$ ,  $V_{\text{CM}} = V_{\text{IN}-} = 48\text{ V}$  (unless otherwise noted)

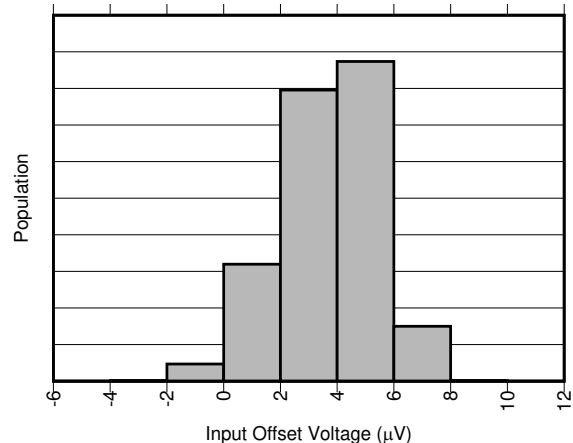
PARAMETER		TEST CONDITIONS	MIN	TYP	MAX	UNIT
<b>INPUT</b>						
CMRR	Common-mode rejection ratio	$V_{\text{CM}} = 2.7\text{ V to }120\text{ V}$ , $T_A = -40\text{ }^\circ\text{C to }+125\text{ }^\circ\text{C}$ $f = 50\text{ kHz}$	140	160 85		dB
$V_{\text{os}}$	Offset voltage, input referred	A1 devices		5	$\pm 25$	$\mu\text{V}$
		A2 devices		3	$\pm 20$	
		A3 devices		3	$\pm 15$	
		A4, A5 devices		2	$\pm 12$	
$dV_{\text{os}}/dT$	Offset voltage drift	$T_A = -40\text{ }^\circ\text{C to }+125\text{ }^\circ\text{C}$			0.2	$\mu\text{V}/^\circ\text{C}$
PSRR	Power supply rejection ratio, input referred	$V_S = 2.7\text{ V to }20\text{ V}$ , $T_A = -40\text{ }^\circ\text{C to }+125\text{ }^\circ\text{C}$		0.05	$\pm 0.5$	$\mu\text{V}/\text{V}$
$I_B$	Input bias current	$I_{B+}$ , $V_{\text{SENSE}} = 0\text{ mV}$	10	20	30	$\mu\text{A}$
		$I_{B-}$ , $V_{\text{SENSE}} = 0\text{ mV}$	10	20	30	
<b>OUTPUT</b>						
G	Gain	A1 devices		20		V/V
		A2 devices		50		
		A3 devices		100		
		A4 devices		200		
		A5 devices		500		
	Gain error	A1, A2, A3 devices, $\text{GND} + 50\text{ mV} \leq V_{\text{OUT}} \leq V_S - 200\text{ mV}$		0.02	$\pm 0.1$	%
		A4, A5 devices, $\text{GND} + 50\text{ mV} \leq V_{\text{OUT}} \leq V_S - 200\text{ mV}$		0.02	$\pm 0.15$	
	Gain error drift	$T_A = -40\text{ }^\circ\text{C to }+125\text{ }^\circ\text{C}$		1.5	5	ppm/ $^\circ\text{C}$
	Nonlinearity error			0.01		%
	Maximum capacitive load	No sustained oscillations, no isolation resistor		500		pF
<b>VOLTAGE OUTPUT</b>						
	Swing to $V_S$ power supply rail	$R_{\text{LOAD}} = 10\text{ k}\Omega$ , $T_A = -40\text{ }^\circ\text{C to }+125\text{ }^\circ\text{C}$		$V_S - 0.07$	$V_S - 0.2$	V
	Swing to ground	$R_{\text{LOAD}} = 10\text{ k}\Omega$ , $V_{\text{SENSE}} = 0\text{ V}$ , $T_A = -40\text{ }^\circ\text{C to }+125\text{ }^\circ\text{C}$		0.005	0.025	V
<b>FREQUENCY RESPONSE</b>						
BW	Bandwidth	A1 devices, $C_{\text{LOAD}} = 5\text{ pF}$ , $V_{\text{SENSE}} = 200\text{ mV}$		1100		kHz
		A2 devices, $C_{\text{LOAD}} = 5\text{ pF}$ , $V_{\text{SENSE}} = 80\text{ mV}$		1100		
		A3 devices, $C_{\text{LOAD}} = 5\text{ pF}$ , $V_{\text{SENSE}} = 40\text{ mV}$		900		
		A4 devices, $C_{\text{LOAD}} = 5\text{ pF}$ , $V_{\text{SENSE}} = 20\text{ mV}$		850		
		A5 devices, $C_{\text{LOAD}} = 5\text{ pF}$ , $V_{\text{SENSE}} = 8\text{ mV}$		800		
SR	Slew rate			2		V/ $\mu\text{s}$
	Settling time	$V_{\text{OUT}} = 4\text{ V} \pm 0.1\text{ V}$ step, output settles to 0.5%		9		$\mu\text{s}$
		$V_{\text{OUT}} = 4\text{ V} \pm 0.1\text{ V}$ step, output settles to 1%		5		
<b>NOISE</b>						
$V_{e_n}$	Voltage noise density			50		nV/ $\sqrt{\text{Hz}}$
<b>POWER SUPPLY</b>						
$V_S$	Supply voltage	$T_A = -40\text{ }^\circ\text{C to }+125\text{ }^\circ\text{C}$	2.7		20	V
$I_Q$	Quiescent current, INA290			370	500	$\mu\text{A}$
		$T_A = -40\text{ }^\circ\text{C to }+125\text{ }^\circ\text{C}$			600	

### 6.6 Typical Characteristics

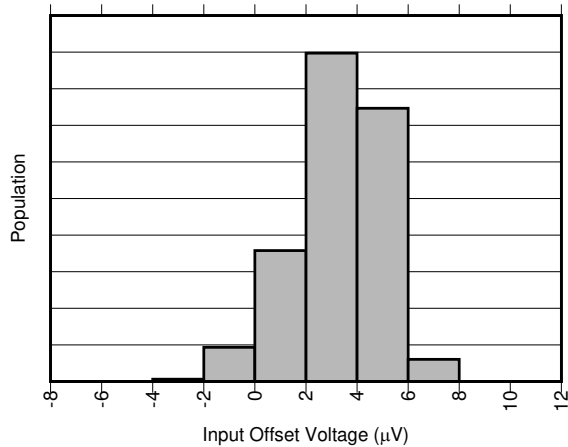
All specifications at  $T_A = 25\text{ }^\circ\text{C}$ ,  $V_S = 5\text{ V}$ ,  $V_{\text{SENSE}} = V_{\text{IN}+} - V_{\text{IN}-} = 0.5\text{ V} / \text{Gain}$ , and  $V_{\text{CM}} = V_{\text{IN}-} = 48\text{ V}$ , unless otherwise noted.



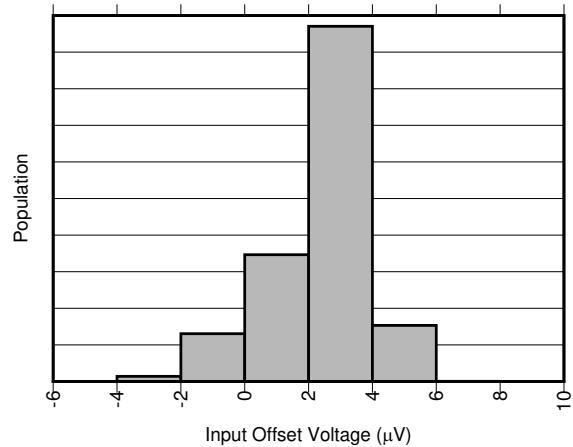
**Figure 6-1. Input Offset Production Distribution, A1 Devices**



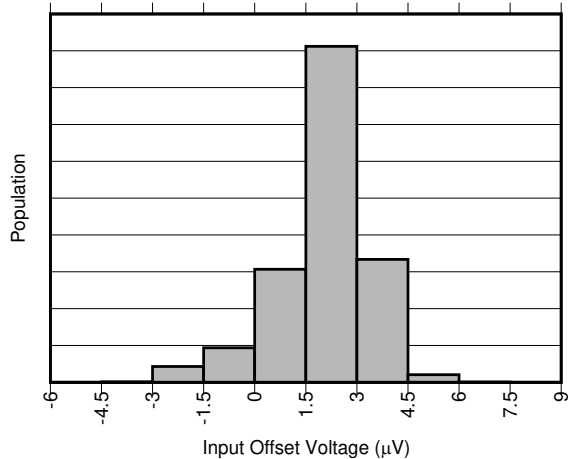
**Figure 6-2. Input Offset Production Distribution, A2 Devices**



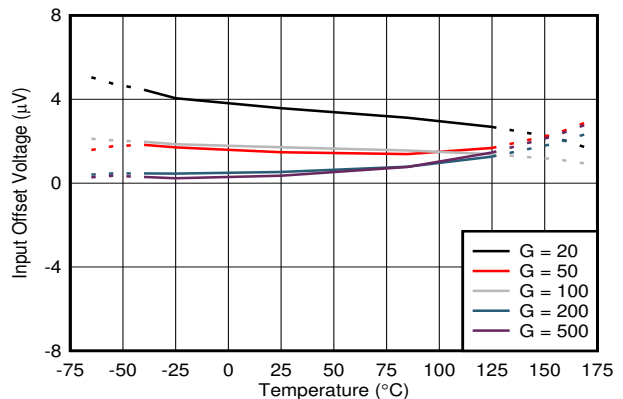
**Figure 6-3. Input Offset Production Distribution, A3 Devices**



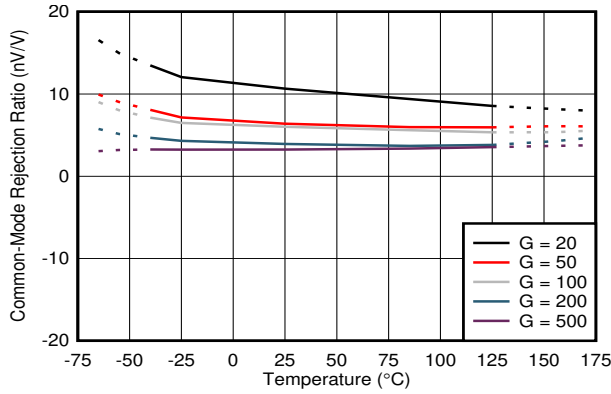
**Figure 6-4. Input Offset Production Distribution, A4 Devices**



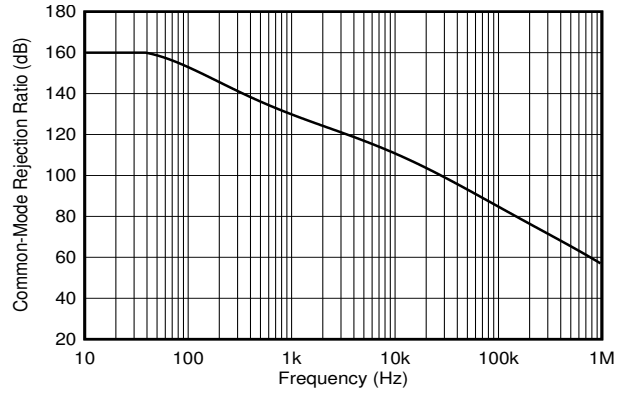
**Figure 6-5. Input Offset Production Distribution, A5 Devices**



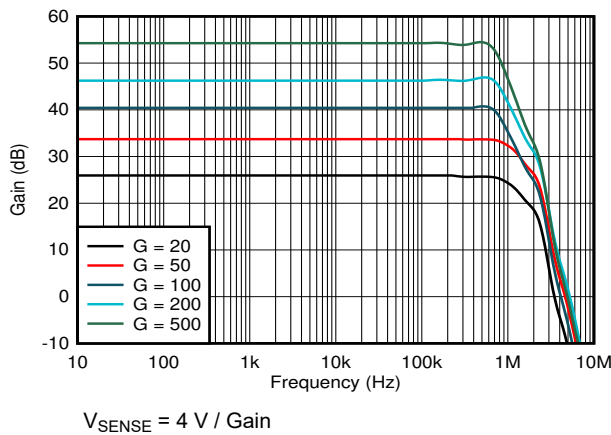
**Figure 6-6. Input Offset Voltage vs Temperature**



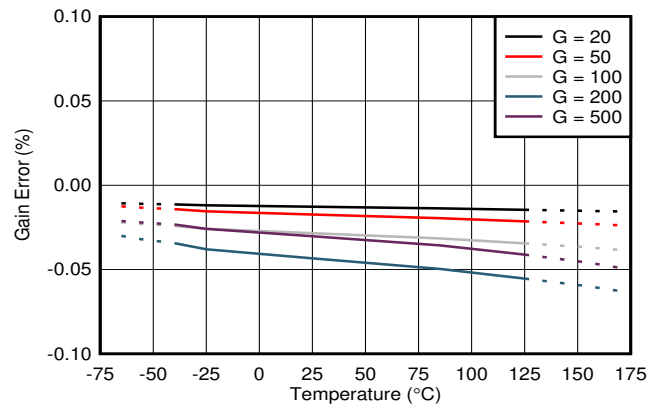
**Figure 6-7. Common-Mode Rejection Ratio vs Temperature**



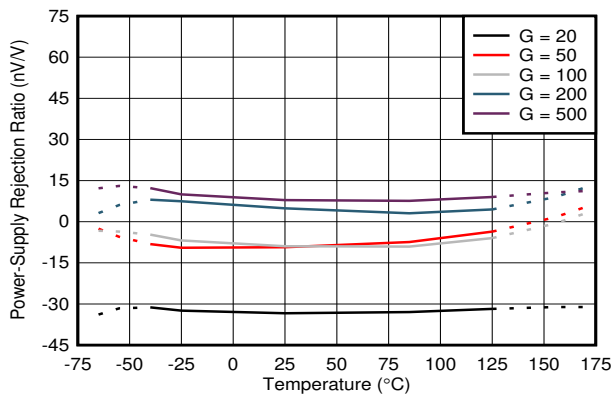
**Figure 6-8. Common-Mode Rejection Ratio vs Frequency**



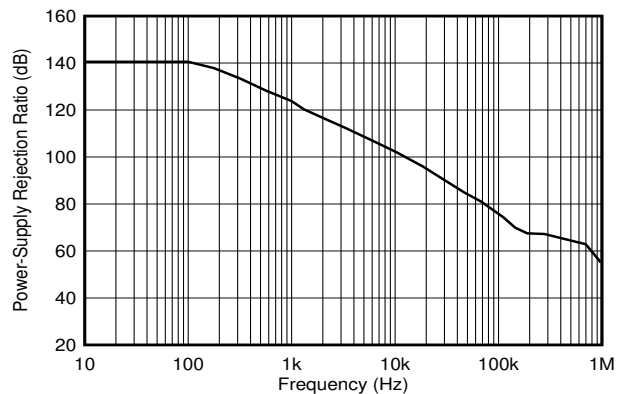
**Figure 6-9. Gain vs Frequency**



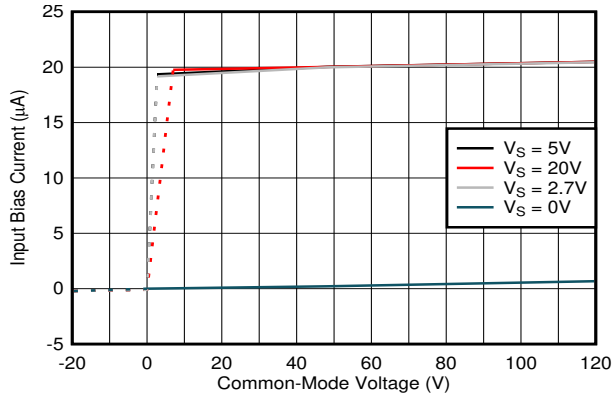
**Figure 6-10. Gain Error vs Temperature**



**Figure 6-11. Power-Supply Rejection Ratio vs Temperature**

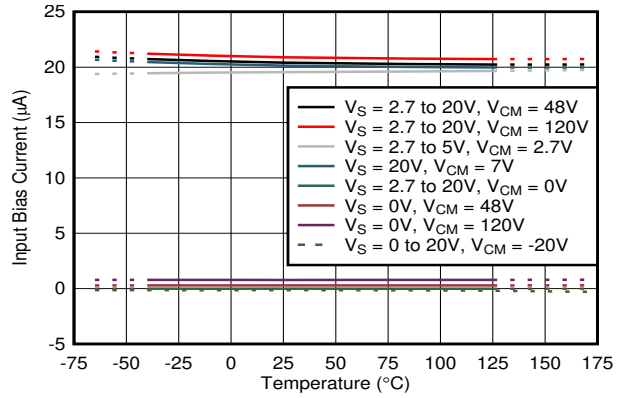


**Figure 6-12. Power-Supply Rejection Ratio vs Frequency**

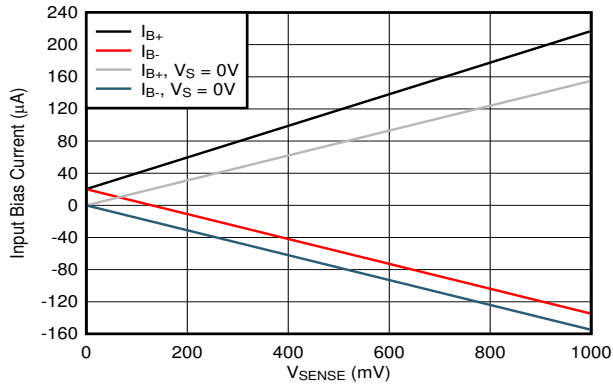


$V_{SENSE} = 0\text{ V}$

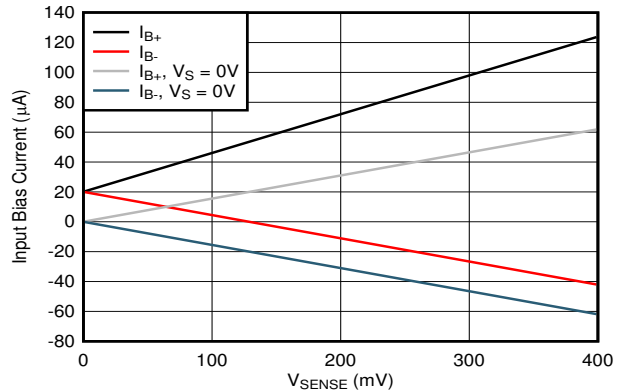
**Figure 6-13. Input Bias Current vs Common-Mode Voltage**



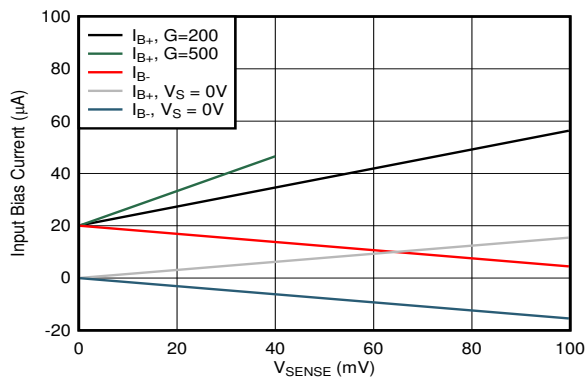
**Figure 6-14. Input Bias Current vs Temperature**



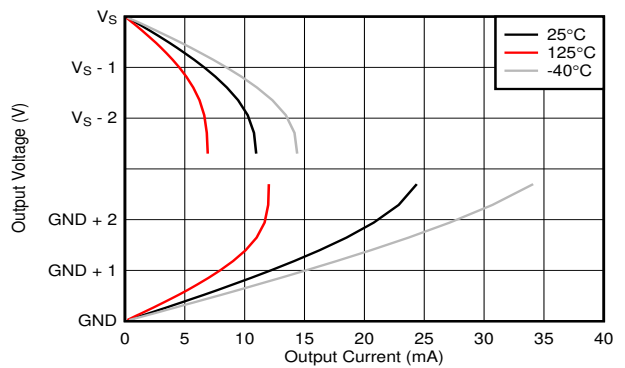
**Figure 6-15. Input Bias Current vs  $V_{SENSE}$ , A1 Devices**



**Figure 6-16. Input Bias Current vs  $V_{SENSE}$ , A2 and A3 Devices**



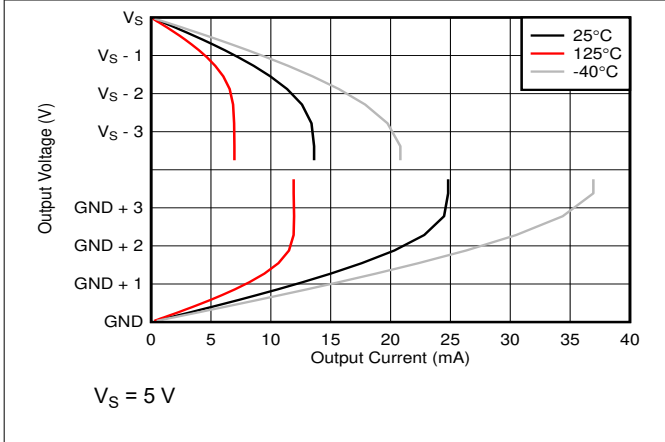
**Figure 6-17. Input Bias Current vs  $V_{SENSE}$ , A4 and A5 Devices**



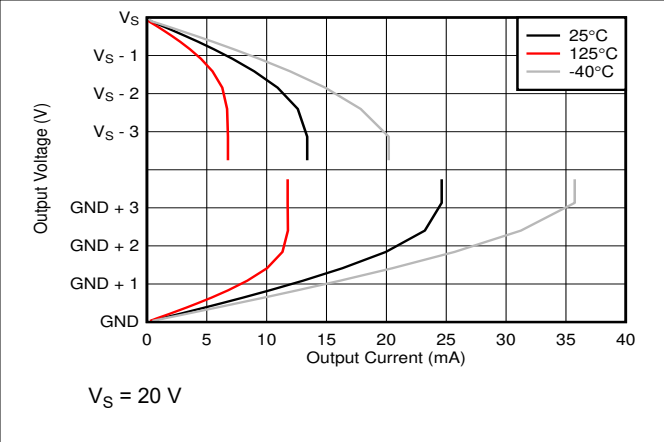
$V_S = 2.7\text{ V}$

**Figure 6-18. Output Voltage vs Output Current**

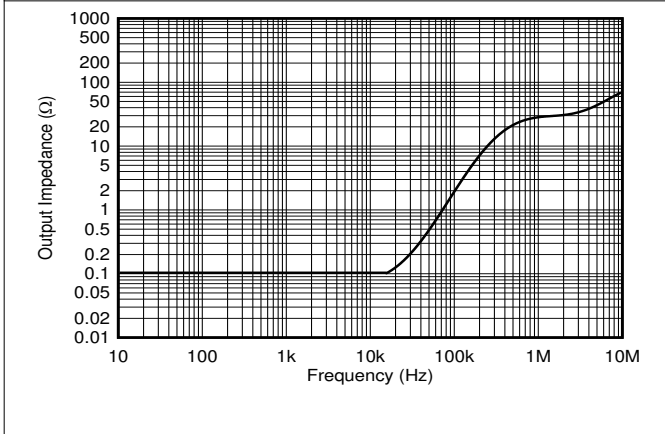




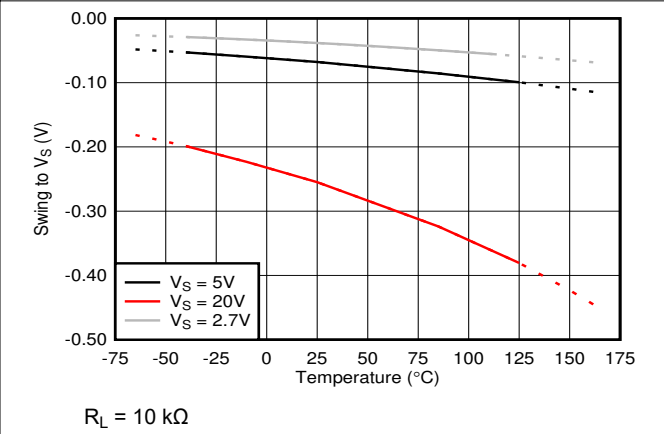
**Figure 6-19. Output Voltage vs Output Current**



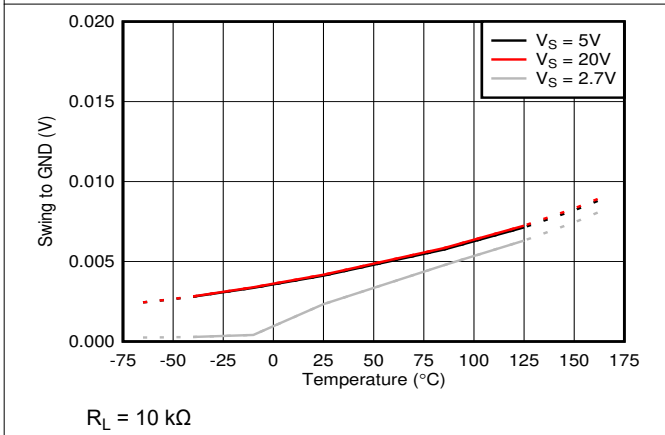
**Figure 6-20. Output Voltage vs Output Current**



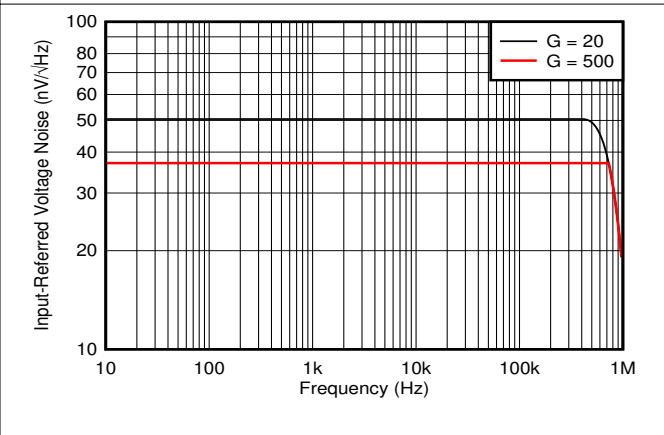
**Figure 6-21. Output Impedance vs Frequency**



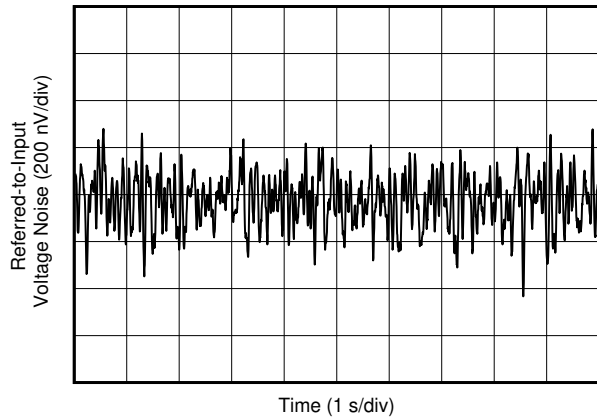
**Figure 6-22. Swing to Supply vs Temperature**



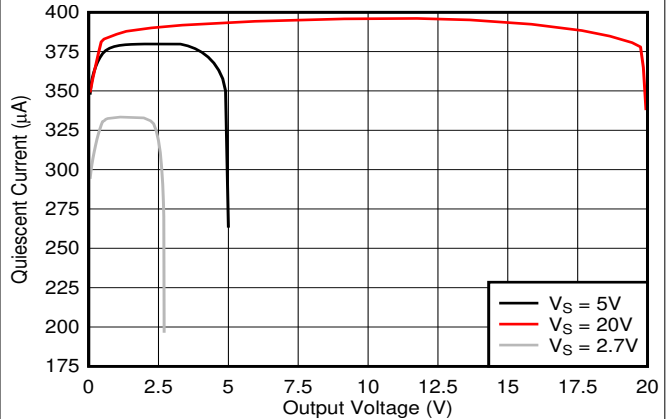
**Figure 6-23. Swing to GND vs Temperature**



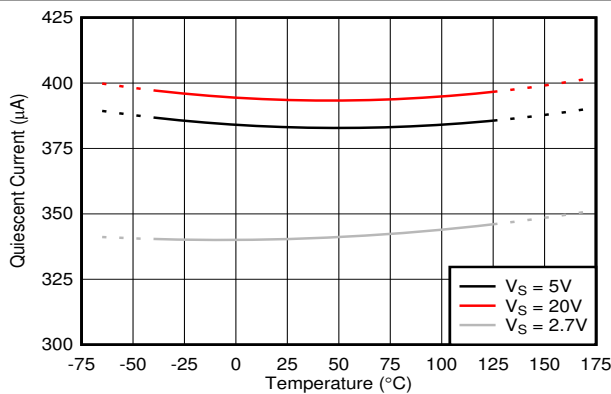
**Figure 6-24. Input Referred Noise vs Frequency**



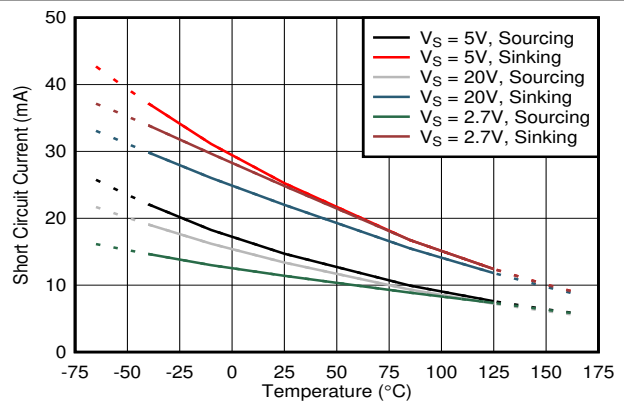
**Figure 6-25. Input Referred Noise**



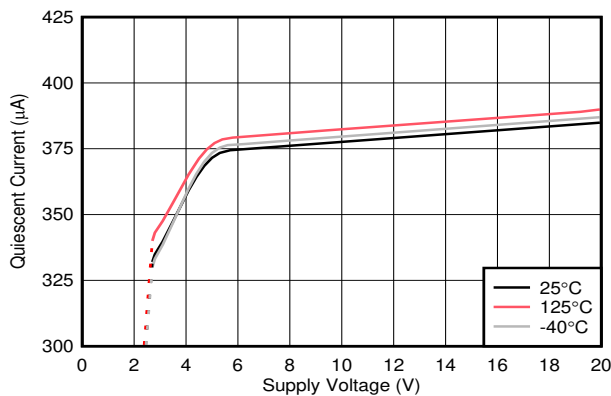
**Figure 6-26. Quiescent Current vs Output Voltage, INA290**



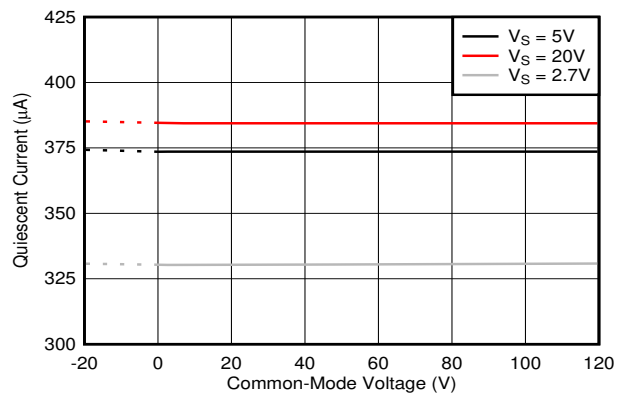
**Figure 6-27. Quiescent Current vs Temperature, INA290**



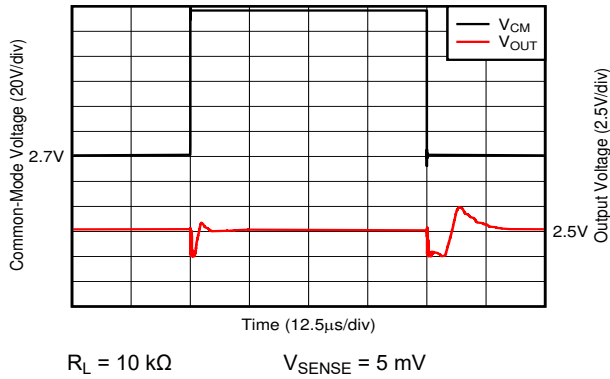
**Figure 6-28. Short-Circuit Current vs Temperature**



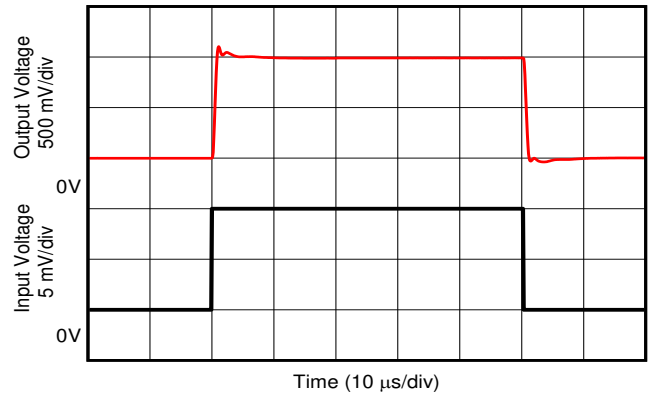
**Figure 6-29. Quiescent Current vs Supply Voltage, INA290**



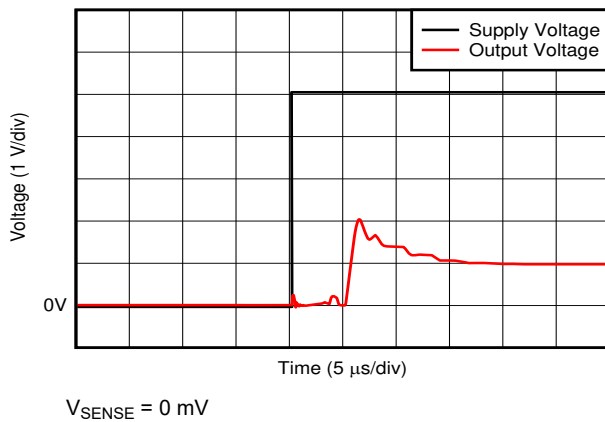
**Figure 6-30. Quiescent Current vs Common-Mode Voltage, INA290**



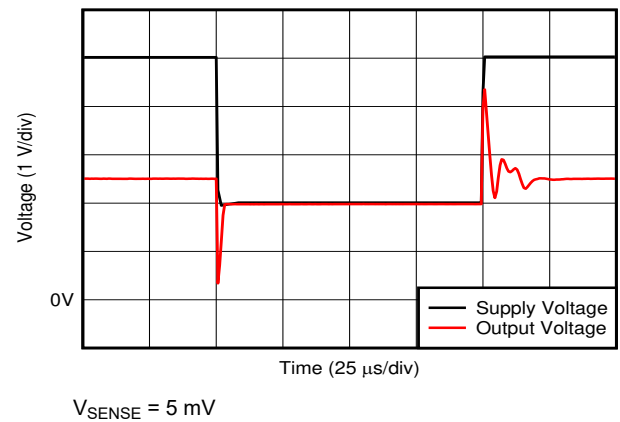
**Figure 6-31. Common-Mode Voltage Fast Transient Pulse, A5 DeviceAs**



**Figure 6-32. Step Response, A3 Devices**



**Figure 6-33. Start-Up Response**



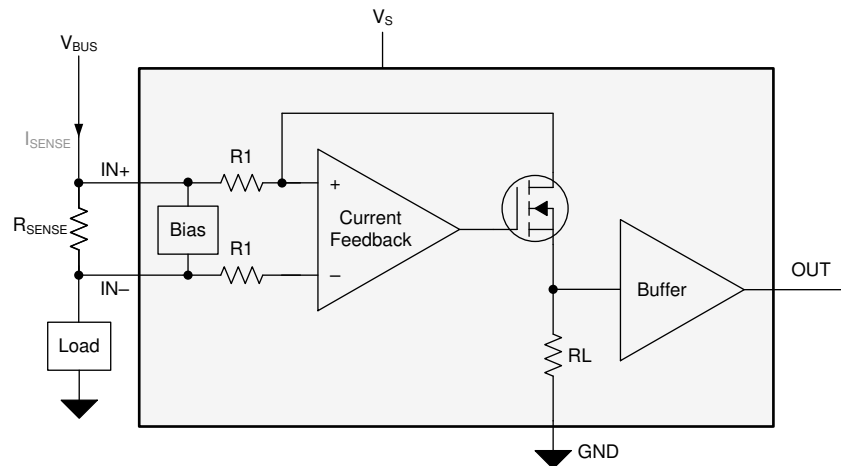
**Figure 6-34. Supply Transient Response, A5 Devices**

## 7 Detailed Description

### 7.1 Overview

The INA290-Q1 is a high-side only current-sense amplifier that offers a wide common-mode range, precision zero-drift topology, excellent common-mode rejection ratio (CMRR), high bandwidth, and fast slew rate. Different gain versions are available to optimize the output dynamic range based on the application. The INA290-Q1 is designed using a transconductance architecture with a current-feedback amplifier that enables low bias currents of 20  $\mu$ A and a common-mode voltage of 120 V.

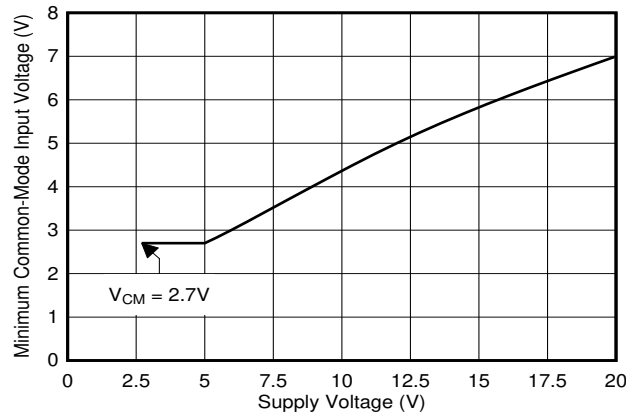
### 7.2 Functional Block Diagram



## 7.3 Feature Description

### 7.3.1 Amplifier Input Common-Mode Range

The INA290-Q1 supports large input common-mode voltages from 2.7 V to 120 V and features a high DC CMRR of 160 dB (typical) and a 85-dB AC CMRR at 50 kHz. The minimum common-mode voltage is restricted by the supply voltage as shown in Figure 7-1. The topology of the internal amplifiers INA290-Q1 restricts operation to high-side, current-sensing applications.

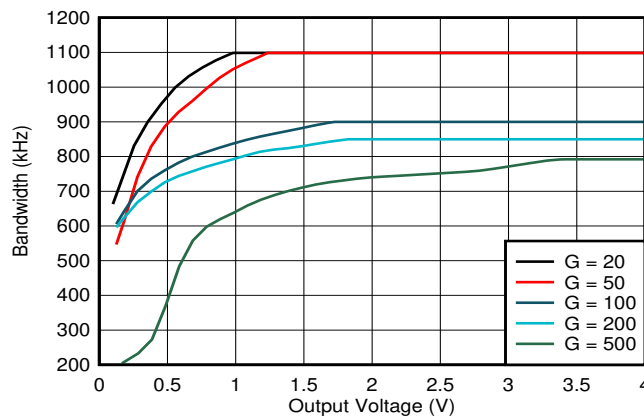


**Figure 7-1. Minimum Common-Mode Voltage vs Supply**

#### 7.3.1.1 Input-Signal Bandwidth

The INA290-Q1 –3-dB bandwidth is gain dependent with several gain options of 20 V/V, 50 V/V, 100 V/V, 200 V/V, and 500 V/V as shown in Figure 6-8. The unique multistage design enables the amplifier to achieve high bandwidth at all gains. This high bandwidth provides the throughput and fast response that is required for the rapid detection and processing of overcurrent events.

The bandwidth of the device also depends on the applied  $V_{SENSE}$  voltage. Figure 7-2 shows the bandwidth performance profile of the device over frequency as output voltage increases for each gain variation. As shown in Figure 7-2, the device exhibits the highest bandwidth with higher  $V_{SENSE}$  voltages, and the bandwidth is higher with lower device gain options. Individual requirements determine the acceptable limits of error for high-frequency, current-sensing applications. Testing and evaluation in the end application or circuit is required to determine the acceptance criteria and validate whether or not the performance levels meet the system specifications.



**Figure 7-2. Bandwidth vs Output Voltage**

### 7.3.1.2 Low Input Bias Current

The INA290-Q1 input bias current draws 20  $\mu\text{A}$  (typical) even with common-mode voltages as high as 120 V. This enables precision current sensing in applications where the sensed current is small or applications that require lower input leakage current.

### 7.3.1.3 Low $V_{\text{SENSE}}$ Operation

The INA290-Q1 enables accurate current measurement across the entire valid  $V_{\text{SENSE}}$  range. The zero-drift input architecture of the INA290-Q1 provides the low offset voltage and low offset drift needed to measure low  $V_{\text{SENSE}}$  levels accurately across the wide operating temperature of  $-40\text{ }^{\circ}\text{C}$  to  $+125\text{ }^{\circ}\text{C}$ . The capability to measure low sense voltages enables accurate measurements at lower load currents, and also allows reduction of the sense resistor value for a given operating current, which minimizes the power loss in the current sensing element.

### 7.3.1.4 Wide Fixed Gain Output

The INA290-Q1 gain error is  $< 0.1\%$  at room temperature for most gain options, with a maximum drift of 5 ppm/ $^{\circ}\text{C}$  over the full temperature range of  $-40\text{ }^{\circ}\text{C}$  to  $+125\text{ }^{\circ}\text{C}$ . The INA290-Q1 is available in multiple gain options of 20 V/V, 50 V/V, 100 V/V, 200 V/V, and 500 V/V, which the system designer should select based on their desired signal-to-noise ratio and other system requirements.

The INA290-Q1 closed-loop gain is set by a precision, low-drift internal resistor network. The ratio of these resistors are excellently matched, while the absolute values may vary significantly. TI does not recommend adding additional resistance around the INA290-Q1 to change the effective gain because of this variation, however. The typical values of the gain resistors are described in [Table 7-1](#).

**Table 7-1. Fixed Gain Resistor**

GAIN	R1	RL
20 (V/V)	25 k $\Omega$	500 k $\Omega$
50 (V/V)	10 k $\Omega$	500 k $\Omega$
100 (V/V)	10 k $\Omega$	1000 k $\Omega$
200 (V/V)	5 k $\Omega$	1000 k $\Omega$
500 (V/V)	2 k $\Omega$	1000 k $\Omega$

### 7.3.1.5 Wide Supply Range

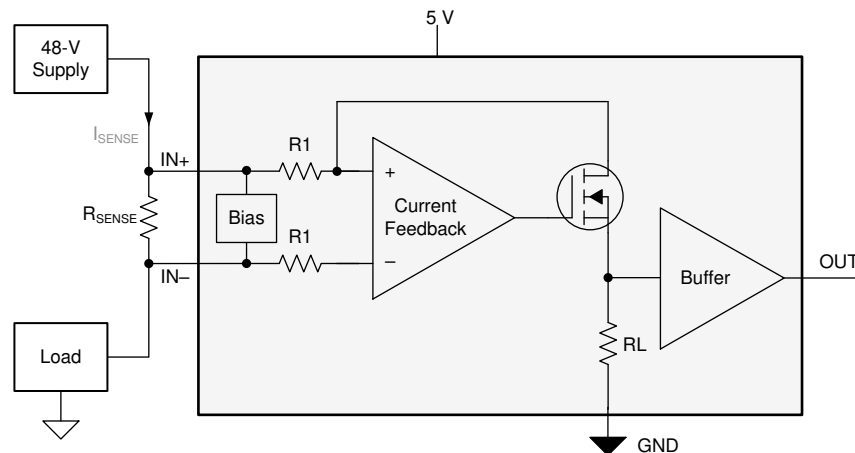
The INA290-Q1 operates with a wide supply range from a 2.7 V to 20 V. The output stage supports a full-scale output voltage range of up to  $V_{\text{S}}$ . Wide output range can enable very-wide dynamic range current measurements. For a gain of 20 V/V, the maximum differential input acceptable is 1 V.

The offset of the gain of INA290-Q1A1 device is  $\pm 25\text{ }\mu\text{V}$ , and the INA290-Q1A1 is capable of measuring a wide dynamic range of current up to 92 dB.

## 7.4 Device Functional Modes

### 7.4.1 Unidirectional Operation

The INA290-Q1 measures the differential voltage developed by current flowing through a resistor that is commonly referred to as a current-sensing resistor or a current-shunt resistor. The INA290-Q1 operates in unidirectional mode only, meaning it only senses current sourced from a power supply to a system load as shown in Figure 7-3.



**Figure 7-3. Unidirectional Application**

The linear range of the output stage is limited to how close the output voltage can approach ground under zero-input conditions. The zero current output voltage of the INA290-Q1 is very small, with a maximum of GND + 25 mV. Make sure to apply a sense voltage of (25 mV / Gain) or greater to keep the INA290-Q1 output in the linear region of operation.

### 7.4.2 High Signal Throughput

With a bandwidth of 1.1 MHz at a gain of 20 V/V and a slew rate of 2 V/ $\mu$ s, the INA290-Q1 is specifically designed for detecting and protecting applications from fast inrush currents. As shown in Table 7-2, the INA290-Q1 responds in less than 2  $\mu$ s for a system measuring a 75-A threshold on a 2-m $\Omega$  shunt.

**Table 7-2. Response Time**

PARAMETER		EQUATION	INA290-Q1 AT $V_S = 5\text{ V}$
G	Gain		20 V/V
$I_{MAX}$	Maximum current		100 A
$I_{Threshold}$	Threshold current		75 A
$R_{SENSE}$	Current sense resistor value		2 m $\Omega$
$V_{OUT\_MAX}$	Output voltage at maximum current	$V_{OUT} = I_{MAX} \times R_{SENSE} \times G$	4 V
$V_{OUT\_THR}$	Output voltage at threshold current	$V_{OUT\_THR} = I_{THR} \times R_{SENSE} \times G$	3 V
SR	Slew rate		2 V/ $\mu$ s
	Output response time	$T_{response} = V_{OUT\_THR} / SR$	< 2 $\mu$ s

## 8 Application and Implementation

### Note

Information in the following applications sections is not part of the TI component specification, and TI does not warrant its accuracy or completeness. TI's customers are responsible for determining suitability of components for their purposes. Customers should validate and test their design implementation to confirm system functionality.

### 8.1 Application Information

The INA290-Q1 amplifies the voltage developed across a current-sensing resistor as current flows through the resistor to the load. The wide input common-mode voltage range and high common-mode rejection of the INA290-Q1 allows use over a wide range of voltage rails while still maintaining an accurate current measurement.

#### 8.1.1 R<sub>SENSE</sub> and Device Gain Selection

The accuracy of any current-sense amplifier is maximized by choosing the current-sense resistor to be as large as possible. A large sense resistor maximizes the differential input signal for a given amount of current flow and reduces the error contribution of the offset voltage. However, there are practical limits as to how large the current-sense resistor can be in a given application because of the resistor size and maximum allowable power dissipation. Equation 1 gives the maximum value for the current-sense resistor for a given power dissipation budget:

$$R_{\text{SENSE}} < \frac{PD_{\text{MAX}}}{I_{\text{MAX}}^2} \quad (1)$$

where:

- $PD_{\text{MAX}}$  is the maximum allowable power dissipation in  $R_{\text{SENSE}}$ .
- $I_{\text{MAX}}$  is the maximum current that will flow through  $R_{\text{SENSE}}$ .

An additional limitation on the size of the current-sense resistor and device gain is due to the power-supply voltage,  $V_S$ , and device swing-to-rail limitations. To make sure that the current-sense signal is properly passed to the output, both positive and negative output swing limitations must be examined. Equation 2 provides the maximum values of  $R_{\text{SENSE}}$  and GAIN to keep the device from exceeding the positive swing limitation.

$$I_{\text{MAX}} \times R_{\text{SENSE}} \times \text{GAIN} < V_{\text{SP}} \quad (2)$$

where:

- $I_{\text{MAX}}$  is the maximum current that will flow through  $R_{\text{SENSE}}$ .
- GAIN is the gain of the current-sense amplifier.
- $V_{\text{SP}}$  is the positive output swing as specified in the data sheet.

To avoid positive output swing limitations when selecting the value of  $R_{\text{SENSE}}$ , there is always a trade-off between the value of the sense resistor and the gain of the device under consideration. If the sense resistor selected for the maximum power dissipation is too large, then it is possible to select a lower-gain device in order to avoid positive swing limitations.

The negative swing limitation places a limit on how small the sense resistor value can be for a given application. Equation 3 provides the limit on the minimum value of the sense resistor.

$$I_{\text{MIN}} \times R_{\text{SENSE}} \times \text{GAIN} > V_{\text{SN}} \quad (3)$$

where:

- $I_{\text{MIN}}$  is the minimum current that will flow through  $R_{\text{SENSE}}$ .



- GAIN is the gain of the current-sense amplifier.
- $V_{SN}$  is the negative output swing of the device.

Table 8-1 shows an example of the different results obtained from using five different gain versions of the INA290-Q1. From the table data, the highest gain device allows a smaller current-shunt resistor and decreased power dissipation in the element.

**Table 8-1.  $R_{SENSE}$  Selection and Power Dissipation**

PARAMETER <sup>(1)</sup>		EQUATION	RESULTS AT $V_S = 5\text{ V}$				
			INA290A1Q	INA290A2Q	INA290A3Q	INA290A4Q	INA290A5Q
G	Gain		20 V/V	50 V/V	100 V/V	200 V/V	500 V/V
$V_{SENSE}$	Ideal differential input voltage (Ignores swing limitation and power supply variation.)	$V_{SENSE} = V_{OUT} / G$	250 mV	100 mV	50 mV	25 mV	10 mV
$R_{SENSE}$	Current sense resistor value	$R_{SENSE} = V_{SENSE} / I_{MAX}$	25 mΩ	10 mΩ	5 mΩ	2.5 mΩ	1 mΩ
$P_{SENSE}$	Current-sense resistor power dissipation	$R_{SENSE} \times I_{MAX}^2$	2.5 W	1 W	0.5W	0.25 W	0.1 W

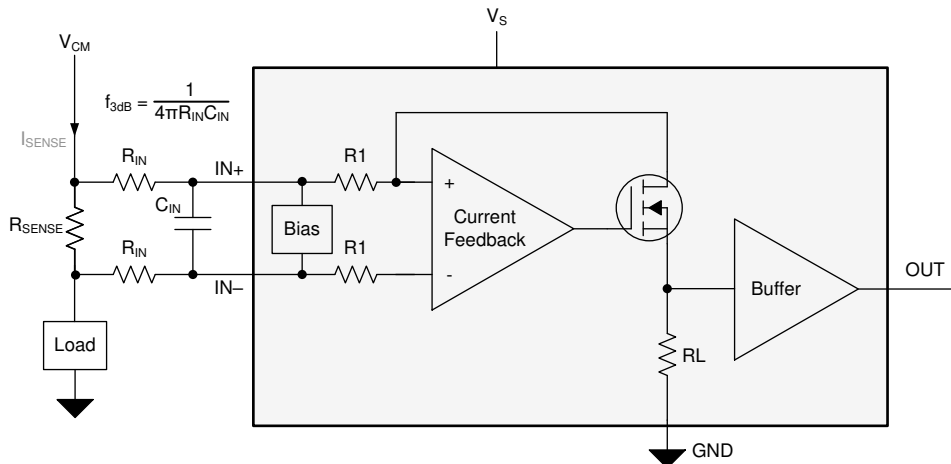
(1) Design example with 10-A full-scale current with maximum output voltage set to 5 V.

### 8.1.2 Input Filtering

#### Note

Input filters are not required for accurate measurements using the INA290-Q1, and use of filters in this location is not recommended. If filter components are used on the input of the amplifier, follow the guidelines in this section to minimize the effects on performance.

Based strictly on user design requirements, external filtering of the current signal may be desired. The initial location that can be considered for the filter is at the output of the current-sense amplifier. Although placing the filter at the output satisfies the filtering requirements, this location changes the low output impedance measured by any circuitry connected to the output voltage pin. The other location for filter placement is at the current-sense amplifier input pins. This location also satisfies the filtering requirement, but the components must be carefully selected to minimally impact device performance. Figure 8-1 shows a filter placed at the input pins.



**Figure 8-1. Filter at Input Pins**

External series resistance provides a source of additional measurement error, so keep the value of these series resistors to 10 Ω or less to reduce loss of accuracy. The internal bias network shown in Figure 8-1 creates a mismatch in input bias currents (see Figure 6-15, Figure 6-16, and Figure 6-17) when a differential voltage is applied between the input pins. If additional external series filter resistors are added to the circuit, a mismatch is created in the voltage drop across the filter resistors. This voltage is a differential error voltage in the shunt resistor voltage. In addition to the absolute resistor value, mismatch resulting from resistor tolerance can significantly impact the error because this value is calculated based on the actual measured resistance.

The measurement error expected from the additional external filter resistors can be calculated using Equation 4, where the gain error factor is calculated using Equation 5.

$$\text{Gain Error (\%)} = 100 \times (\text{Gain Error Factor} - 1) \tag{4}$$

The gain error factor, shown in Equation 4, can be calculated to determine the gain error introduced by the additional external series resistance. Equation 4 calculates the deviation of the shunt voltage, resulting from the attenuation and imbalance created by the added external filter resistance. Table 8-2 provides the gain error factor and gain error for several resistor values.

$$\text{Gain Error Factor} = \frac{R_B \times R_1}{(R_B \times R_1) + (R_B \times R_{IN}) + (2 \times R_{IN} \times R_1)} \tag{5}$$

Where:

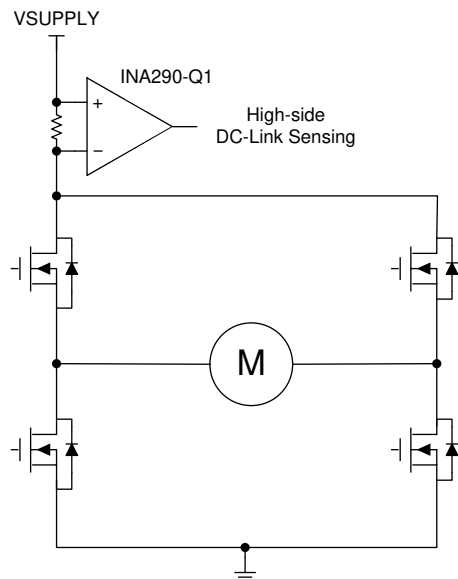
- $R_{IN}$  is the external filter resistance value.
- $R_1$  is the INA290-Q1 input resistance value specified in Table 7-1.
- $R_B$  is the internal bias resistance, which is  $6600 \Omega \pm 20\%$ .

**Table 8-2. Example Gain Error Factor and Gain Error for 10-Ω External Filter Input Resistors**

DEVICE (GAIN)	GAIN ERROR FACTOR	GAIN ERROR (%)
A1 devices (20)	0.99658	-0.34185
A2 devices (50)	0.99598	-0.40141
A3 devices (100)	0.99598	-0.40141
A4 devices (200)	0.99499	-0.50051
A5 devices (500)	0.99203	-0.79663

## 8.2 Typical Application

The INA290-Q1 is a unidirectional, current-sense amplifier capable of measuring currents through a resistive shunt with shunt common-mode voltages from 2.7 V to 120 V. The circuit configuration for monitoring current in a high-side pump or motor is shown in Figure 8-2 .



**Figure 8-2. Current Sensing in a Automotive Pump**

### 8.2.1 Design Requirements

$V_{SUPPLY}$  is set to 5 V, and the common-mode voltage set to 48 V. [Table 8-3](#) lists the design setup for this application.

**Table 8-3. Design Parameters**

DESIGN PARAMETERS	EXAMPLE VALUE
INA290-Q1 supply voltage	5 V
High-side supply voltage	48 V
Maximum sense current ( $I_{MAX}$ )	5 A
Gain option	50 V/V

### 8.2.2 Detailed Design Procedure

The maximum value of the current-sense resistor is calculated based choice of gain, value of the maximum current the be sensed ( $I_{MAX}$ ), and the power-supply voltage ( $V_S$ ). When operating at the maximum current, the output voltage must not exceed the positive output swing specification,  $V_{SP}$ . Under the given design parameters, [Equation 6](#) calculates the maximum value for  $R_{SENSE}$  as 19.2 m $\Omega$ .

$$R_{SENSE} < \frac{V_{SP}}{I_{MAX} \times GAIN} \quad (6)$$

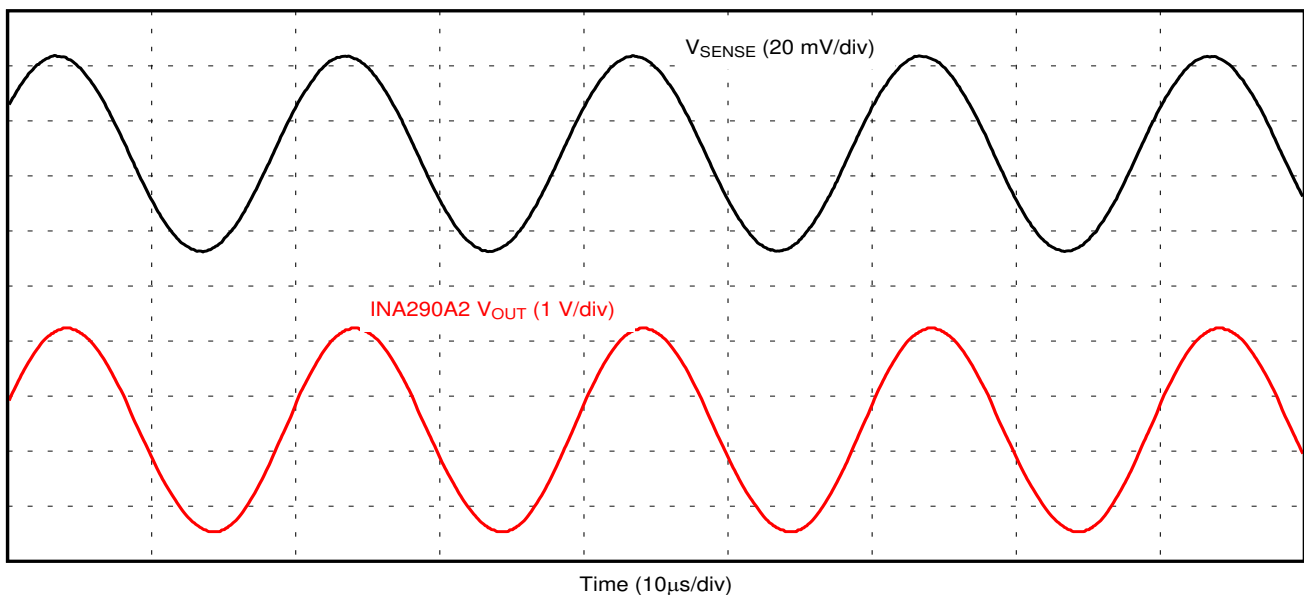
For this design example, a value of 15 m $\Omega$  is selected because, while the 15 m $\Omega$  is less than the maximum value calculated, 15 m $\Omega$  is still large enough to give adequate signal at the current-sense amplifier output.

#### 8.2.2.1 Overload Recovery With Negative $V_{SENSE}$

The INA290-Q1 is a unidirectional current-sense amplifier that is meant to operate with a positive differential input voltage ( $V_{SENSE}$ ). If negative  $V_{SENSE}$  is applied, the device is placed in an overload condition and requires time to recover once  $V_{SENSE}$  returns positive. The required overload recovery time increases with more negative  $V_{SENSE}$ .

### 8.2.3 Application Curve

[Figure 8-3](#) shows the output response of the device to a high frequency sinusoidal current.



**Figure 8-3. INA290-Q1 Output Response**

## 9 Power Supply Recommendations

The input circuitry of the INA290-Q1 device can accurately measure beyond the power-supply voltage. The power supply can be 20 V, whereas the load power-supply voltage at IN+ and IN– can go up to 120 V. The output voltage range of the OUT pin is limited by the voltage on the  $V_S$  pin and the device swing to supply specification.

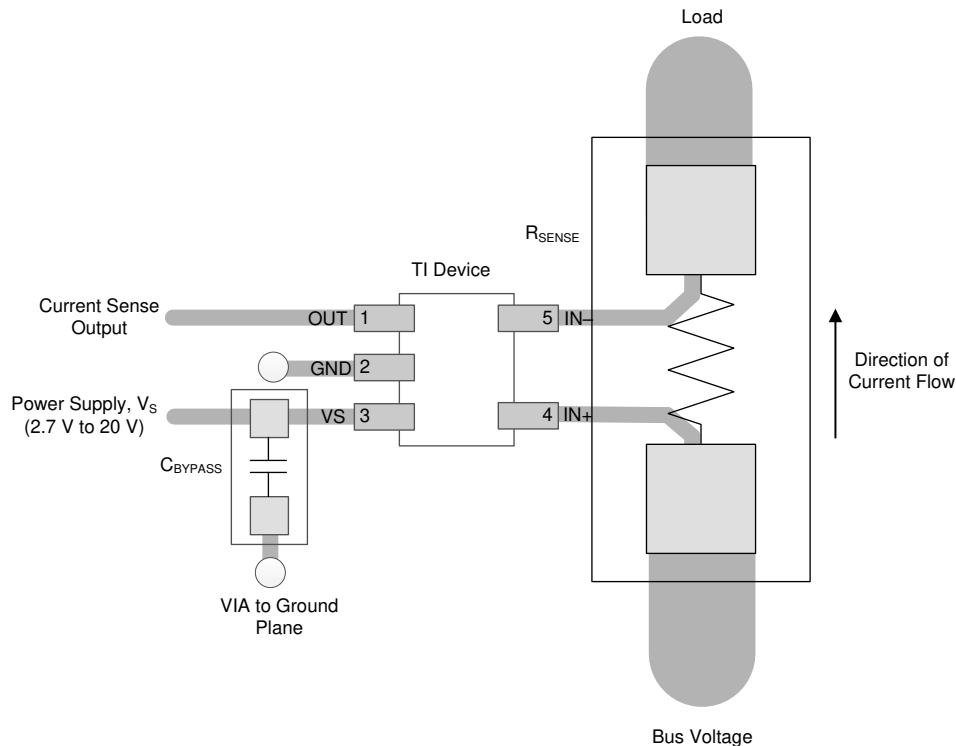
## 10 Layout

### 10.1 Layout Guidelines

TI always recommends to follow good layout practices:

- Connect the input pins to the sensing resistor using a Kelvin or 4-wire connection. This connection technique makes sure that only the current-sensing resistor impedance is detected between the input pins. Poor routing of the current-sensing resistor commonly results in additional resistance present between the input pins. Given the very low ohmic value of the current resistor, any additional high-current carrying impedance can cause significant measurement errors.
- Place the power-supply bypass capacitor as close to the device power supply and ground pins as possible. The recommended value of this bypass capacitor is 0.1  $\mu\text{F}$ . Additional decoupling capacitance can be added to compensate for noisy or high-impedance power supplies.
- When routing the connections from the current-sense resistor to the device, keep the trace lengths as short as possible.

### 10.2 Layout Example



**Figure 10-1. Recommended Layout for INA290-Q1**

## 11 Device and Documentation Support

### 11.1 Documentation Support

#### 11.1.1 Related Documentation

For related documentation, see the following:

Texas Instruments, [INA290EVM User's Guide](#)

### 11.2 Receiving Notification of Documentation Updates

To receive notification of documentation updates, navigate to the device product folder on [ti.com](#). Click on *Subscribe to updates* to register and receive a weekly digest of any product information that has changed. For change details, review the revision history included in any revised document.

### 11.3 Support Resources

[TI E2E™ support forums](#) are an engineer's go-to source for fast, verified answers and design help — straight from the experts. Search existing answers or ask your own question to get the quick design help you need.

Linked content is provided "AS IS" by the respective contributors. They do not constitute TI specifications and do not necessarily reflect TI's views; see TI's [Terms of Use](#).

### 11.4 Trademarks

TI E2E™ is a trademark of Texas Instruments.

All trademarks are the property of their respective owners.

### 11.5 Electrostatic Discharge Caution



This integrated circuit can be damaged by ESD. Texas Instruments recommends that all integrated circuits be handled with appropriate precautions. Failure to observe proper handling and installation procedures can cause damage.

ESD damage can range from subtle performance degradation to complete device failure. Precision integrated circuits may be more susceptible to damage because very small parametric changes could cause the device not to meet its published specifications.

### 11.6 Glossary

[TI Glossary](#) This glossary lists and explains terms, acronyms, and definitions.

## 12 Mechanical, Packaging, and Orderable Information

The following pages include mechanical, packaging, and orderable information. This information is the most current data available for the designated devices. This data is subject to change without notice and revision of this document. For browser-based versions of this data sheet, refer to the left-hand navigation.

**PACKAGING INFORMATION**

Orderable Device	Status (1)	Package Type	Package Drawing	Pins	Package Qty	Eco Plan (2)	Lead finish/ Ball material (6)	MSL Peak Temp (3)	Op Temp (°C)	Device Marking (4/5)	Samples
INA290A1QDCKRQ1	ACTIVE	SC70	DCK	5	3000	RoHS & Green	NIPDAU	Level-1-260C-UNLIM	-40 to 125	1G6	<a href="#">Samples</a>
INA290A2QDCKRQ1	ACTIVE	SC70	DCK	5	3000	RoHS & Green	NIPDAU	Level-1-260C-UNLIM	-40 to 125	1G8	<a href="#">Samples</a>
INA290A3QDCKRQ1	ACTIVE	SC70	DCK	5	3000	RoHS & Green	NIPDAU	Level-1-260C-UNLIM	-40 to 125	1G7	<a href="#">Samples</a>
INA290A4QDCKRQ1	ACTIVE	SC70	DCK	5	3000	RoHS & Green	NIPDAU	Level-1-260C-UNLIM	-40 to 125	1G9	<a href="#">Samples</a>
INA290A5QDCKRQ1	ACTIVE	SC70	DCK	5	3000	RoHS & Green	NIPDAU	Level-1-260C-UNLIM	-40 to 125	1GA	<a href="#">Samples</a>

(1) The marketing status values are defined as follows:

**ACTIVE:** Product device recommended for new designs.

**LIFEBUY:** TI has announced that the device will be discontinued, and a lifetime-buy period is in effect.

**NRND:** Not recommended for new designs. Device is in production to support existing customers, but TI does not recommend using this part in a new design.

**PREVIEW:** Device has been announced but is not in production. Samples may or may not be available.

**OBSELETE:** TI has discontinued the production of the device.

(2) **RoHS:** TI defines "RoHS" to mean semiconductor products that are compliant with the current EU RoHS requirements for all 10 RoHS substances, including the requirement that RoHS substance do not exceed 0.1% by weight in homogeneous materials. Where designed to be soldered at high temperatures, "RoHS" products are suitable for use in specified lead-free processes. TI may reference these types of products as "Pb-Free".

**RoHS Exempt:** TI defines "RoHS Exempt" to mean products that contain lead but are compliant with EU RoHS pursuant to a specific EU RoHS exemption.

**Green:** TI defines "Green" to mean the content of Chlorine (Cl) and Bromine (Br) based flame retardants meet JS709B low halogen requirements of <=1000ppm threshold. Antimony trioxide based flame retardants must also meet the <=1000ppm threshold requirement.

(3) MSL, Peak Temp. - The Moisture Sensitivity Level rating according to the JEDEC industry standard classifications, and peak solder temperature.

(4) There may be additional marking, which relates to the logo, the lot trace code information, or the environmental category on the device.

(5) Multiple Device Markings will be inside parentheses. Only one Device Marking contained in parentheses and separated by a "~" will appear on a device. If a line is indented then it is a continuation of the previous line and the two combined represent the entire Device Marking for that device.

(6) Lead finish/Ball material - Orderable Devices may have multiple material finish options. Finish options are separated by a vertical ruled line. Lead finish/Ball material values may wrap to two lines if the finish value exceeds the maximum column width.

**Important Information and Disclaimer:** The information provided on this page represents TI's knowledge and belief as of the date that it is provided. TI bases its knowledge and belief on information provided by third parties, and makes no representation or warranty as to the accuracy of such information. Efforts are underway to better integrate information from third parties. TI has taken and continues to take reasonable steps to provide representative and accurate information but may not have conducted destructive testing or chemical analysis on incoming materials and chemicals. TI and TI suppliers consider certain information to be proprietary, and thus CAS numbers and other limited information may not be available for release.

In no event shall TI's liability arising out of such information exceed the total purchase price of the TI part(s) at issue in this document sold by TI to Customer on an annual basis.

**OTHER QUALIFIED VERSIONS OF INA290-Q1 :**

- Catalog: [INA290](#)

NOTE: Qualified Version Definitions:

- Catalog - TI's standard catalog product

**TAPE AND REEL INFORMATION**

**QUADRANT ASSIGNMENTS FOR PIN 1 ORIENTATION IN TAPE**


\*All dimensions are nominal

Device	Package Type	Package Drawing	Pins	SPQ	Reel Diameter (mm)	Reel Width W1 (mm)	A0 (mm)	B0 (mm)	K0 (mm)	P1 (mm)	W (mm)	Pin1 Quadrant
INA290A1QDCKRQ1	SC70	DCK	5	3000	180.0	8.4	2.47	2.3	1.25	4.0	8.0	Q3
INA290A2QDCKRQ1	SC70	DCK	5	3000	180.0	8.4	2.47	2.3	1.25	4.0	8.0	Q3
INA290A3QDCKRQ1	SC70	DCK	5	3000	180.0	8.4	2.47	2.3	1.25	4.0	8.0	Q3
INA290A4QDCKRQ1	SC70	DCK	5	3000	180.0	8.4	2.47	2.3	1.25	4.0	8.0	Q3
INA290A5QDCKRQ1	SC70	DCK	5	3000	180.0	8.4	2.47	2.3	1.25	4.0	8.0	Q3



**TAPE AND REEL BOX DIMENSIONS**


\*All dimensions are nominal

Device	Package Type	Package Drawing	Pins	SPQ	Length (mm)	Width (mm)	Height (mm)
INA290A1QDCKRQ1	SC70	DCK	5	3000	183.0	183.0	20.0
INA290A2QDCKRQ1	SC70	DCK	5	3000	183.0	183.0	20.0
INA290A3QDCKRQ1	SC70	DCK	5	3000	183.0	183.0	20.0
INA290A4QDCKRQ1	SC70	DCK	5	3000	183.0	183.0	20.0
INA290A5QDCKRQ1	SC70	DCK	5	3000	183.0	183.0	20.0

DCK (R-PDSO-G5)

PLASTIC SMALL-OUTLINE PACKAGE



- NOTES:
- A. All linear dimensions are in millimeters.
  - B. This drawing is subject to change without notice.
  - C. Body dimensions do not include mold flash or protrusion. Mold flash and protrusion shall not exceed 0.15 per side.
  - D. Falls within JEDEC MO-203 variation AA.

DCK (R-PDSO-G5)

PLASTIC SMALL OUTLINE



- NOTES:
- All linear dimensions are in millimeters.
  - This drawing is subject to change without notice.
  - Customers should place a note on the circuit board fabrication drawing not to alter the center solder mask defined pad.
  - Publication IPC-7351 is recommended for alternate designs.
  - Laser cutting apertures with trapezoidal walls and also rounding corners will offer better paste release. Customers should contact their board assembly site for stencil design recommendations. Example stencil design based on a 50% volumetric metal load solder paste. Refer to IPC-7525 for other stencil recommendations.

## IMPORTANT NOTICE AND DISCLAIMER

TI PROVIDES TECHNICAL AND RELIABILITY DATA (INCLUDING DATA SHEETS), DESIGN RESOURCES (INCLUDING REFERENCE DESIGNS), APPLICATION OR OTHER DESIGN ADVICE, WEB TOOLS, SAFETY INFORMATION, AND OTHER RESOURCES "AS IS" AND WITH ALL FAULTS, AND DISCLAIMS ALL WARRANTIES, EXPRESS AND IMPLIED, INCLUDING WITHOUT LIMITATION ANY IMPLIED WARRANTIES OF MERCHANTABILITY, FITNESS FOR A PARTICULAR PURPOSE OR NON-INFRINGEMENT OF THIRD PARTY INTELLECTUAL PROPERTY RIGHTS.

These resources are intended for skilled developers designing with TI products. You are solely responsible for (1) selecting the appropriate TI products for your application, (2) designing, validating and testing your application, and (3) ensuring your application meets applicable standards, and any other safety, security, regulatory or other requirements.

These resources are subject to change without notice. TI grants you permission to use these resources only for development of an application that uses the TI products described in the resource. Other reproduction and display of these resources is prohibited. No license is granted to any other TI intellectual property right or to any third party intellectual property right. TI disclaims responsibility for, and you will fully indemnify TI and its representatives against, any claims, damages, costs, losses, and liabilities arising out of your use of these resources.

TI's products are provided subject to [TI's Terms of Sale](#) or other applicable terms available either on [ti.com](http://ti.com) or provided in conjunction with such TI products. TI's provision of these resources does not expand or otherwise alter TI's applicable warranties or warranty disclaimers for TI products.

TI objects to and rejects any additional or different terms you may have proposed.

Mailing Address: Texas Instruments, Post Office Box 655303, Dallas, Texas 75265  
Copyright © 2022, Texas Instruments Incorporated