

Buffer Amplifier 35 - 45 GHz

Rev. V1

Features

- High Dynamic Range
- Excellent LO Driver/Buffer Amplifier
- Low Noise or Power Bias Configurations
- 23.0 dB Small Signal Gain
- 2.7 dB Noise Figure at Low Noise Bias
- +16 dBm P1dB Compression at Power Bias
- 100% On-Wafer RF, DC and Noise Figure Testing
- 100% Commercial-Level Visual Inspection Using Mil-Std-883 Method 2010
- RoHS* Compliant and 260°C Reflow Compatible

Description

M/A-COM Tech's three stage 35.0-45.0 GHz GaAs MMIC buffer amplifier has a small signal gain of 23.0 dB with a noise figure of 2.7 dB across the band. This MMIC uses M/A-COM Tech's GaAs PHEMT device model technology, and is based upon electron beam lithography to ensure high repeatability and uniformity. The chip has surface passivation to protect and provide a rugged part with backside via holes and gold metallization to allow either a conductive epoxy or eutectic solder die attach process. This device is well suited for Millimeter-wave Point-to-Point Radio, SATCOM and VSAT applications.

Chip Device Layout

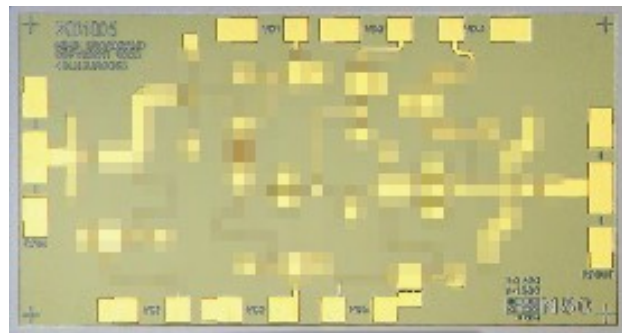

Absolute Maximum Ratings

Parameter	Absolute Max.
Supply Voltage (Vd)	+6.0 VDC
Supply Current (Id)	180 mA
Gate Bias Voltage (Vg)	+0.3 V
Input Power (Pin)	+5 dBm
Storage Temperature (Tstg)	-65 °C to +165 °C
Operating Temperature (Ta)	-55 °C to MTTF Table ¹
Channel Temperature (Tch)	MTTF Table ¹

1. Channel temperature directly affects a device's MTTF. Channel temperature should be kept as low as possible to maximize lifetime.

Ordering Information

Part Number	Package
XB1005-BD-000V	"V" - vacuum release gel paks
XB1005-BD-EV1	evaluation module

Electrical Specifications: 35-45 GHz (Ambient Temperature T = 25°C)

Parameter	Units	Min.	Typ.	Max.
Input Return Loss (S11) ³	dB	4.0	8.0	-
Output Return Loss (S22) ³	dB	9.0	17.0	-
Small Signal Gain (S21) ³	dB	20.0	23.0	27.0
Gain Flatness ($\Delta S21$)	dB	-	+/-1.0	-
Reverse Isolation (S12) ³	dB	35.0	45.0	-
Noise Figure (NF) ⁴	dB	-	2.7	3.5
Output Power for 1dB Compression Point (P1dB) ^{1,2,3}	dBm	-	+16.0	-
Output Third Order Intercept Point (OIP3) ^{1,2,3}	dBm	-	+26.0	-
Saturated Output Power (Psat) ^{1,2,3}	dBm	+16.0	+18.0	-
Drain Bias Voltage (Vd1,2,3)	VDC	-1.2	+3.5	+4.5
Gate Bias Voltage (Vg1,2,3)	VDC	-	-0.4	+0.1
Supply Current (Id) (Vd=3.5 V, Vg=-0.4 V Typical)	mA	-	50	154

1. Optional low noise bias Vd1,2,3=3.5 V, Id=50 mA will typically yield 3-4 dB decreased P1dB and OIP3.
2. Measured using constant current.
3. Unless otherwise indicated Min/Max over 35.0-45.0 GHz and biased at Vd=4.5 V, Id1=28 mA, Id2=42 mA, Id3=84 mA.
4. Unless otherwise indicated Min/Max over 35.0-45.0 GHz and biased at Vd=3.5 V, Id1=9 mA, Id2=16 mA, Id3=25 mA.

Handling Procedures

Please observe the following precautions to avoid damage:

Static Sensitivity

Gallium Arsenide Integrated Circuits are sensitive to electrostatic discharge (ESD) and can be damaged by static electricity. Proper ESD control techniques should be used when handling these class 2 devices.

Typical Performance Curves

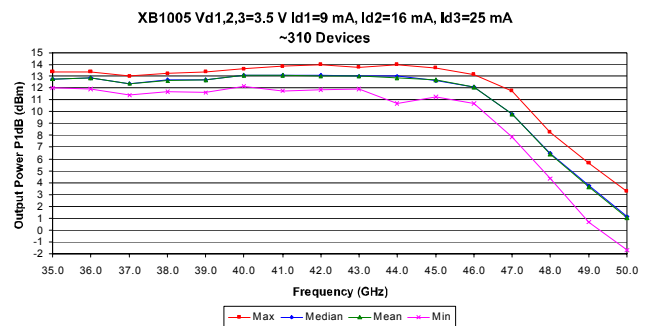
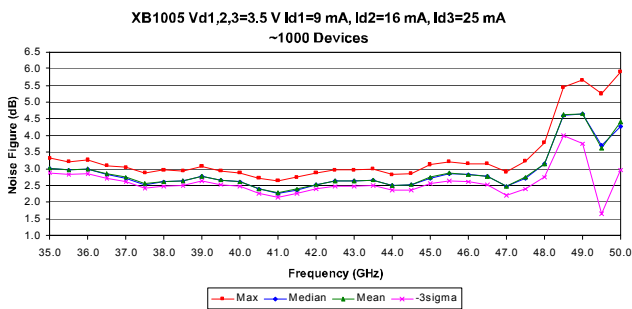
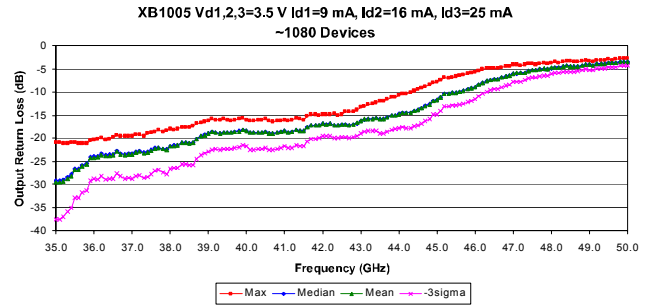
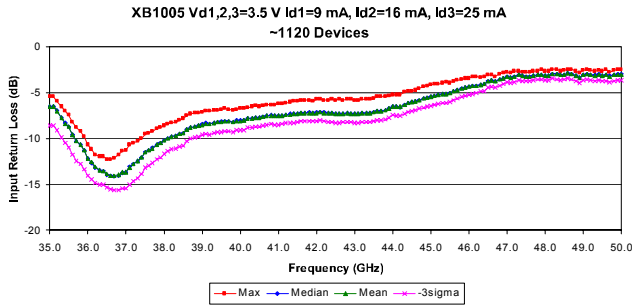
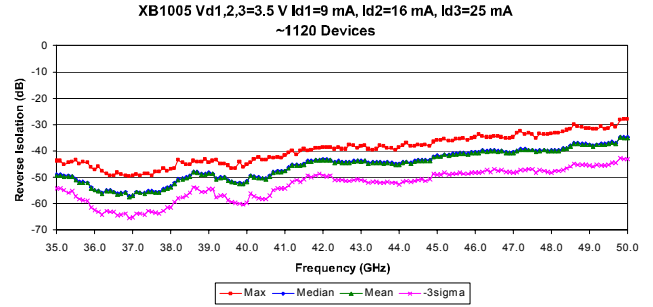
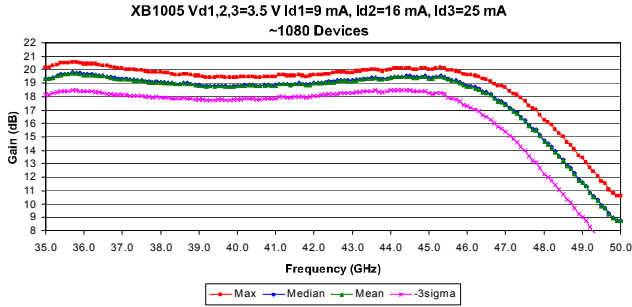

Typical Performance Curves (cont.)

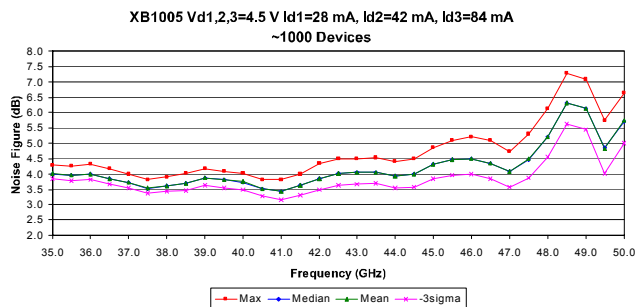
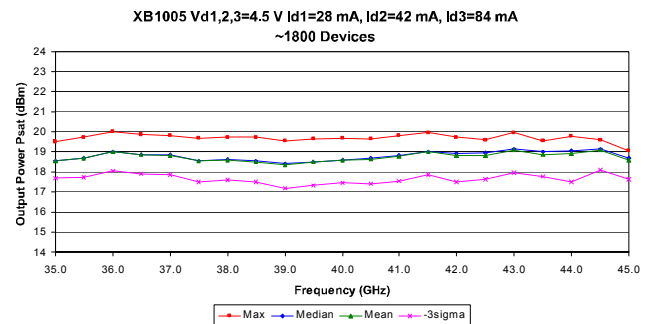
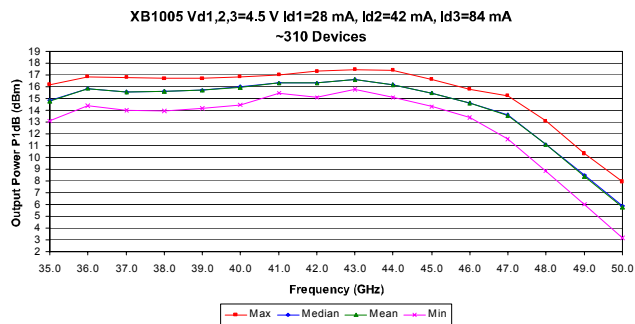
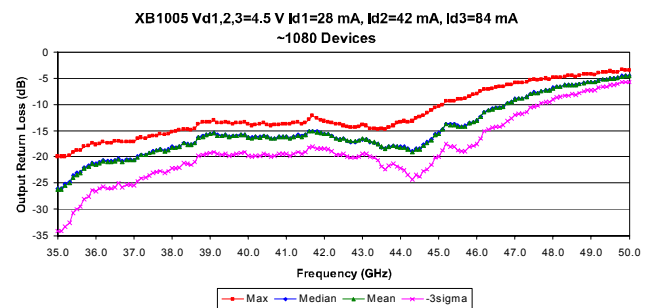
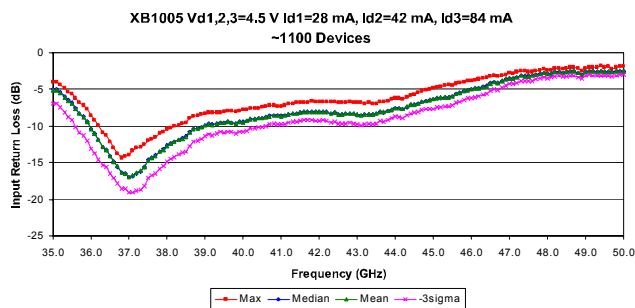
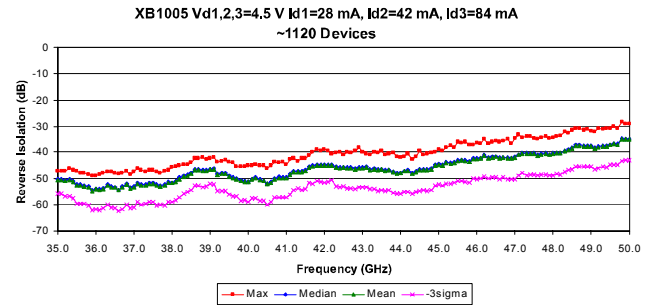
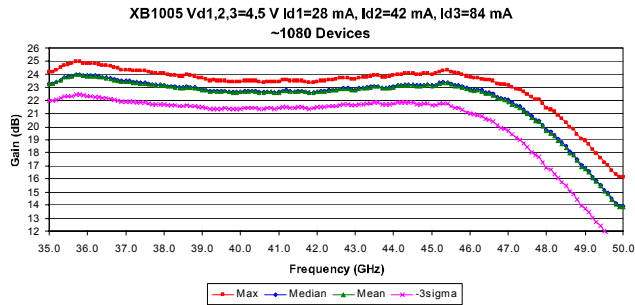

Typical Performance Curves (cont.)

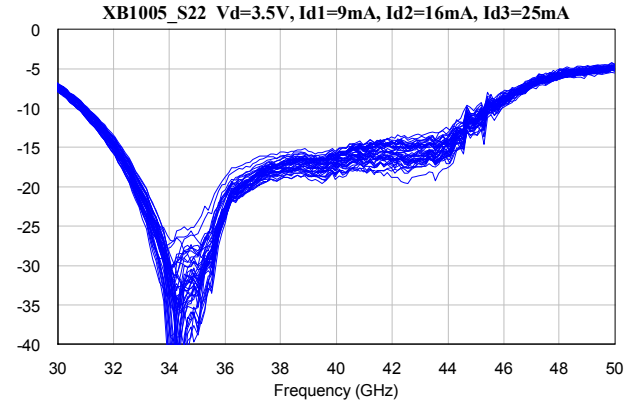
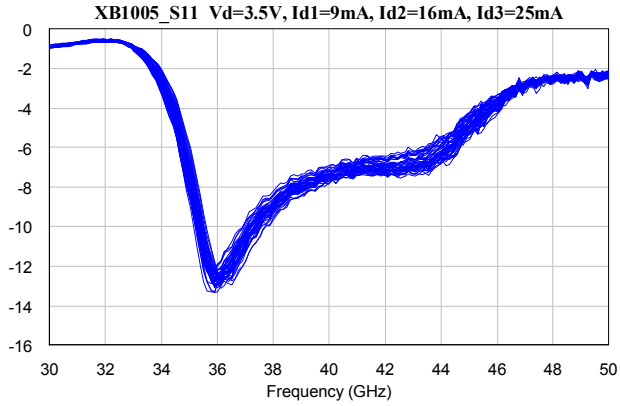
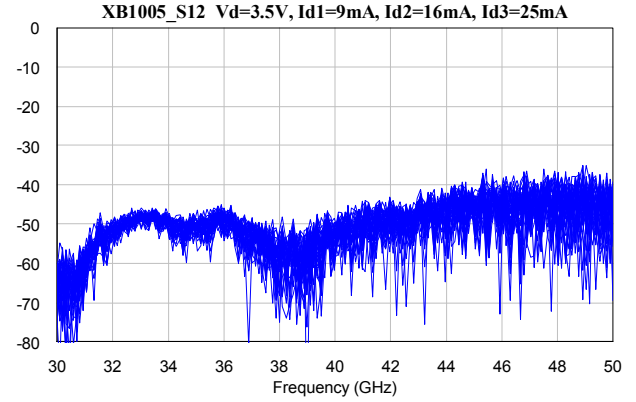
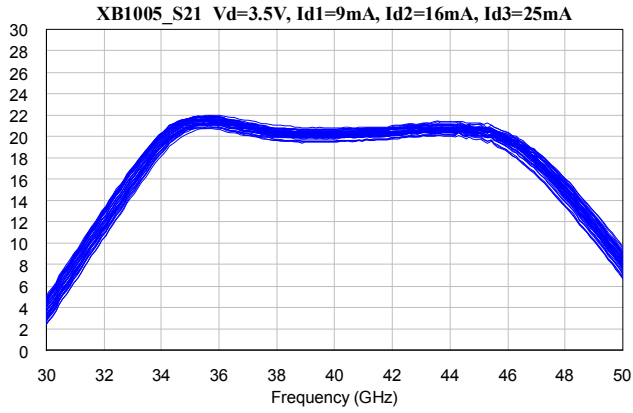

Buffer Amplifier 35 - 45 GHz

Rev. V1

S-Parameters

Typical S-Parameter Data for XB1005
Vd=3.5 V Id1=9 mA Id2=16 mA Id3=25 mA

Frequency (GHz)	S11 Mag dB	S11 Phase Ang°	S12 Mag dB	S12 Phase Ang°	S21 Mag dB	S21 Phase Ang°	S22 Mag dB	S22 Phase Ang°
35.00	-6.574349404	96.934155	-49.23179812	46.37366	19.33564406	138.0651	-29.54354856	32.84849
35.10	-6.574349404	96.934155	-49.23179812	46.37366	19.33564406	138.0651	-29.54354856	32.84849
35.20	-7.035943954	95.96262	-49.71562591	42.81072	19.42221432	134.529	-29.42189926	22.3338
35.30	-7.763233853	95.19547	-49.75431	42.77268	19.52004371	129.55645	-28.73758733	-1.136121
35.40	-8.368616054	94.969455	-49.82639552	31.528745	19.64198557	124.5152	-28.18266901	-24.557125
35.50	-8.75830921	94.37948	-51.10665207	27.269205	19.66011378	120.9992	-26.84896198	-41.61547
35.60	-9.627407977	94.25412	-51.99098528	30.66616	19.65661526	116.2656	-26.85132026	-70.55758
35.70	-10.27509984	95.67452	-52.0400353	26.24862	19.75304897	111.3722	-26.04692291	-97.44931
35.80	-10.67340133	96.278405	-52.22330646	20.729945	19.74856371	108.00495	-25.69833736	-117.72135
35.90	-11.30724615	97.25639	-54.19357879	13.312525	19.68400278	103.31765	-24.32913398	-138.5305
36.00	-12.14203988	99.49448	-54.99640422	22.0719	19.64943787	99.255625	-24.22362391	46.483165
36.10	-12.5918387	101.7401	-55.33268562	17.746545	19.6529033	96.312825	-24.19569905	138.6442
36.20	-13.11438151	105.06055	-56.2746785	23.14153	19.62520326	91.868125	-23.63344626	127.59485
36.30	-13.50612457	109.97635	-55.16108956	30.65822	19.59819734	87.51907	-23.94367056	96.070645
36.40	-13.56112855	112.9002	-55.16168457	18.28701	19.5453406	84.86562	-23.88560216	74.421635
36.50	-13.91064484	117.0479	-55.59147943	21.00572	19.52773532	81.131985	-23.76925849	45.45415
36.60	-14.02940523	120.72915	-56.47360678	0.84859555	19.46661273	76.891215	-23.02019476	12.949405
36.70	-14.09722512	123.7533	-56.22062264	19.85935	19.41522188	74.27667	-23.49624954	-8.8657195
36.80	-13.99090131	129.4492	-55.85220634	40.115175	19.36402559	70.62581	-23.67660445	-36.42533
36.90	-13.69854397	131.91375	-57.48723209	24.939275	19.31449591	66.98345	-23.51241068	-69.57632
37.00	-13.65148375	134.4616	-56.97569603	32.658205	19.29285826	64.629795	-23.61825894	-89.52069
37.10	-13.12124156	137.99005	-55.67328766	53.588735	19.2839546	61.03785	-23.19377503	-117.49435
37.20	-12.76065748	138.7961	-56.0058134	39.46849	19.25186492	57.210645	-22.9877082	-141.59525
37.30	-12.49809671	139.63365	-56.05192442	46.702595	19.22963985	54.87511	-23.31178057	-124.92175
37.40	-12.085169	140.388	-55.38316528	50.100885	19.20209341	51.39268	-23.14799044	118.86945
37.50	-11.52532217	141.32295	-55.37264753	54.58608	19.1871536	47.650795	-22.66839413	131.2743
37.60	-11.33320156	140.21695	-55.89885856	44.82948	19.13996571	45.167775	-22.30853169	109.75585
37.70	-11.05173486	140.36975	-55.89762338	40.89325	19.10350301	41.869145	-22.13949069	79.004675
37.80	-10.71827075	140.8003	-54.77044075	50.17697	19.07765777	38.51507	-22.44120219	47.0785
37.90	-10.52332628	140.2464	-53.98474488	79.74226	19.09200938	36.316135	-22.54208112	29.006905
38.00	-10.21189911	139.0043	-53.65553064	65.31874	19.07616829	32.739225	-21.79326165	-3.559862
38.10	-9.987088158	137.5075	-52.2648892	84.33638	19.01977637	29.34118	-21.66938164	-35.96137
38.20	-9.833079913	137.17935	-51.20234234	105.9827	19.00625544	27.308005	-21.55159039	-55.514215
38.30	-9.698327854	136.0281	-50.59173389	110.4882	18.97755308	23.81317	-20.9765791	-86.04581
38.40	-9.543443271	134.90135	-50.3762445	118.21125	18.94001799	20.645865	-21.05980672	-120.676
38.50	-9.409027497	134.9013	-49.59228347	119.33475	18.93670995	18.725355	-21.17368509	-139.01885
38.60	-9.040955589	134.85355	-48.03754627	113.18935	18.99185512	15.58162	-21.05048178	-121.8418
38.70	-8.800714705	131.65995	-48.29027632	101.1989	18.97299515	11.791705	-20.1489878	122.7398
38.80	-8.703208388	130.1769	-48.80343491	97.61308	18.93634672	9.498006	-19.66997137	135.3003
38.90	-8.63902433	128.284	-48.81672896	94.87015	18.85908267	6.0829785	-19.31866918	102.6629
39.00	-8.480142459	126.6314	-48.61785751	88.45466	18.83839218	2.9406625	-19.01453734	69.19604
39.10	-8.369923771	124.68625	-48.72113777	78.73717	18.81565908	0.88076035	-18.72499175	46.11588
39.20	-8.427875073	122.8696	-50.64224613	73.761565	18.77054317	-1.991481	-18.7526564	9.07431
39.30	-8.315568353	122.26295	-50.19835471	79.29644	18.77888704	-5.113429	-18.93869431	-22.19262
39.40	-8.232545054	120.2927	-50.08805266	73.34956	18.75678569	-7.181793	-18.75833024	-43.81552
39.50	-8.185106043	118.44245	-51.31434164	68.37579	18.78733191	-10.333615	-18.87482355	-79.95618
39.60	-8.121401886	116.0351	-51.83601874	69.50973	18.8049185	-13.73097	-18.82853828	-109.9632
39.70	-8.163314813	114.6738	-52.2118834	72.50816	18.76352543	-15.663855	-18.71788945	-132.01605
39.80	-8.248321162	113.5609	-52.4506074	64.47952	18.74291529	-18.562445	-18.53066122	-120.58325
39.90	-8.08766958	111.6638	-52.5826292	57.43299	18.76615166	-21.68184	-18.24638487	-119.4853
40.00	-8.076113685	110.57015	-51.72732359	41.191535	18.78325176	-23.59218	-18.43298444	135.28465
40.10	-8.038305212	109.59175	-49.4591074	93.103275	18.81409487	-26.792365	-18.90075786	106.94755
40.20	-7.850338854	107.48755	-49.90784635	90.117185	18.82354006	-29.915965	-18.89998381	75.70693
40.30	-7.816975059	105.7612	-50.35320905	82.289435	18.84785061	-32.106125	-18.80903154	53.26226
40.40	-7.742375259	103.19035	-50.49235321	86.679285	18.84637789	-35.713245	-18.74958784	22.70489
40.50	-7.736302989	101.54535	-50.63281702	97.8867	18.78859577	-38.92639	-18.68083434	-13.27563
40.60	-7.654738472	100.6755	-49.56480404	107.96495	18.78114505	-40.81692	-18.92527269	-34.91877
40.70	-7.535634636	98.67975	-48.26259215	114.1522	18.8368798	-43.95932	-19.0631166	-65.76275
40.80	-7.499068023	96.23931	-47.84717769	110.2666	18.84740607	-47.28093	-18.77189433	-97.022095
40.90	-7.529239117	95.167185	-47.901469	108.98	18.80809137	-49.3415	-18.67137457	-119.3506
41.00	-7.538395071	93.155735	-47.64995654	110.62655	18.83861654	-52.17115	-18.49440115	-142.6075
41.10	-7.503931447	91.703165	-46.54373669	110.65035	18.94312254	-55.50936	-18.8320406	49.161785
41.20	-7.415991729	90.3949	-45.39787402	108.66385	18.95224174	-57.874545	-18.68645824	145.14825
41.30	-7.380505087	88.093795	-45.53006203	101.82145	18.91049631	-61.382985	-18.26788571	118.98145
41.40	-7.362181438	86.037305	-45.62937812	103.0279	18.87906615	-64.445505	-18.47803781	87.13567
41.50	-7.319605276	84.793275	-45.05942533	104.75765	18.91900098	-66.597445	-18.37003377	67.12527
41.60	-7.254390805	83.16613	-44.09387428	98.776375	18.95403955	-70.26757	-17.65014218	33.741055
41.70	-7.224069616	80.355795	-43.97854441	93.129505	18.92579681	-73.554915	-17.28607262	-3.17367
41.80	-7.200164767	78.618785	-43.55569363	89.915635	18.89016051	-75.571755	-17.23804094	-28.62363
41.90	-7.241671781	76.64978	-43.53988076	85.2609	18.90647563	-78.3334	-17.23867198	-63.827925
42.00	-7.189371788	74.508965	-43.42556498	79.93518	18.97808281	-81.50841	-16.95746817	-100.29
42.10	-7.152143029	72.521875	-43.42125493	77.69329	18.98909574	-83.81774	-17.01442365	-123.26395
42.20	-7.196346354	69.86536	-43.61374891	69.29075	19.01472126	-87.03284	-16.95388206	-121.35075
42.30	-7.243355781	68.2225	-44.47185195	66.50402	19.07625949	-90.125475	-17.17921412	70.91688
42.40	-7.241902959	66.783595	-44.25773913	68.29368	19.09370199	-92.568385	-17.26787817	137.3589
42.50	-7.347020293	64.60857	-44.38832587	62.471735	19.11164718	-95.86554	-17.01183778	109.31515
42.60	-7.357362911	63.297688	-44.49440554	65.11804	19.15285516	-99.467335	-17.07127278	73.926345
42.70	-7.295175341	61.67555	-44.43858874	67.55022	19.20857434	-101.75575	-17.16417594	50.555415
42.80	-7.240152387	59.041555	-44.2093467	64.81341	19.21554629	-105.5273	-17.03733112	17.322785
42.90	-7.292390588	56.776	-43.95067135	62.048135	19.15570179	-109.1422	-16.73686714	-16.16492

Buffer Amplifier 35 - 45 GHz

Rev. V1

S-Parameters (cont.)

Typical S-Parameter Data for XB1005 (cont'd)
Vd=3.5 V Id1=9 mA Id2=16 mA Id3=25 mA

Frequency (GHz)	S11 Mag dB	S11 Phase Ang°	S12 Mag dB	S12 Phase Ang°	S21 Mag dB	S21 Phase Ang°	S22 Mag dB	S22 Phase Ang°
43.00	-7.345524167	55.462755	-44.04166926	59.1821	19.16457552	-111.166	-16.29154547	-39.681715
43.10	-7.333200996	54.346705	-43.95442975	53.473265	19.23370488	-114.44935	-15.97990648	-77.24261
43.20	-7.242474435	52.699845	-44.68902228	54.42106	19.26189209	-118.0697	-15.87583704	-114.6923
43.30	-7.237938012	51.02437	-44.53087643	54.398005	19.31202092	-120.4098	-15.7992363	-135.9821
43.40	-7.257385181	49.10809	-44.63502112	52.903405	19.33713041	-124.1117	-15.67290846	-45.212675
43.50	-7.158668075	47.77342	-44.58158647	51.4709	19.37592442	-127.93965	-15.86174715	143.867
43.60	-7.00775023	46.671735	-44.75704048	54.833455	19.39380942	-130.363	-15.92531824	128.46935
43.70	-7.008042021	44.64985	-44.44514229	56.009195	19.30991052	-134.07265	-15.55012104	95.986865
43.80	-6.890942814	43.107725	-44.82654044	53.308475	19.29663706	-137.3757	-15.17408183	62.09357
43.90	-6.73956737	41.732585	-45.0635239	51.7693	19.32775106	-139.7067	-15.07142349	36.84572
44.00	-6.504805597	39.421885	-45.12526532	52.623805	19.40386064	-143.176	-14.82345198	1.8310295
44.10	-6.513937949	36.985175	-44.35306964	54.740835	19.45901191	-146.7687	-14.5107601	-33.4216
44.20	-6.576687374	36.17555	-44.2239809	50.952665	19.45692385	-149.65215	-14.57549789	-56.81798
44.30	-6.365722852	35.151365	-44.72226523	51.55257	19.4659016	-153.7627	-14.55256619	-90.27132
44.40	-6.123194875	32.300405	-44.22722825	56.318655	19.50500587	-157.81995	-14.09816919	-122.83385
44.50	-6.041009946	30.85345	-43.7563504	54.20931	19.49951137	-160.73965	-13.90198285	-143.6419
44.60	-5.952334439	28.98021	-43.63931004	51.916805	19.41988741	-164.3943	-13.58027062	-50.47132
44.70	-5.79479387	26.777125	-43.91350214	52.778905	19.42623801	-168.1323	-13.07345537	140.0311
44.80	-5.683124271	25.11386	-43.65197971	57.203335	19.45945803	-169.9022	-12.65587329	126.5153
44.90	-5.525140315	22.59974	-42.24445438	56.204085	19.47563657	-168.24535	-12.01472827	91.67056
45.00	-5.474118706	20.5454	-41.92230636	45.573685	19.36285638	-53.396825	-11.8076845	57.45352
45.10	-5.336052303	19.202115	-42.17698547	43.51246	19.36534995	135.9544	-11.24468537	35.27348
45.20	-5.276774883	16.20149	-41.53279803	41.360965	19.4555715	169.8834	-10.45716391	-1.5405255
45.30	-5.167519793	13.703045	-41.65056554	36.705825	19.47641064	168.61555	-10.33828381	-37.46977
45.40	-5.111338869	11.380125	-41.47903584	36.09244	19.43884015	165.20835	-10.2389002	-60.31871
45.50	-5.077297469	10.47938	-41.20991086	29.35558	19.26216341	160.62965	-10.20041012	-95.88558
45.60	-4.848759061	8.791059	-40.97213326	25.857585	19.18077994	156.5545	-9.957085889	-128.39855
45.70	-4.717849756	7.398656	-41.16337273	24.376625	19.14446261	153.70585	-9.818922157	-141.90145
45.80	-4.576325732	4.3809025	-41.3588791	24.24876	19.03354045	148.88775	-9.452474097	48.944685
45.90	-4.434972362	2.322136	-40.59475632	23.959605	18.85025281	144.5361	-9.200468861	141.09195
46.00	-4.364224029	1.511057	-40.64865584	20.876495	18.76986241	142.18835	-8.932325944	119.983
46.10	-4.282714343	-1.4764015	-40.73562664	19.4775	18.71684481	138.06415	-8.498809473	86.41325
46.20	-4.240329776	-4.5926885	-39.90315152	17.121865	18.63392619	132.7107	-7.985270463	50.105605
46.30	-4.131843795	-6.0012925	-40.26917146	15.494395	18.51810456	129.706	-7.729762962	27.389335
46.40	-4.081757688	-8.1281595	-40.11034651	9.36886	18.31046023	125.2337	-7.458649077	-7.438885
46.50	-3.755911411	-11.08021	-39.91616997	2.578583	18.23770215	120.3275	-7.269040754	-41.93417
46.60	-3.66020822	-13.2806	-40.3509963	1.173214	18.09404167	116.9094	-7.217299506	-65.11463
46.70	-3.780823809	-16.1142	-40.13513493	-3.5226205	17.82614329	111.83385	-6.954301019	-97.986885
46.80	-3.58626412	-18.0313	-40.68458146	-6.961453	17.66500782	107.70195	-6.602155253	-131.7718
46.90	-3.445682511	-19.2976	-40.78038542	-9.712663	17.57061459	105.1626	-6.414754122	-143.6909
47.00	-3.312846513	-22.55169	-40.67518735	-12.55831	17.38102957	100.4856	-6.075003103	47.0983
47.10	-3.356581856	-24.972705	-40.13024591	-3.9820415	17.10981276	95.358105	-5.974207047	136.21805
47.20	-3.273900454	-25.90331	-39.54091246	-8.31326	16.90792678	92.8537	-5.949546583	113.9373
47.30	-3.114343121	-28.13479	-39.63619586	-10.425605	16.73829329	88.914385	-5.785206681	80.227155
47.40	-3.212684901	-31.88044	-39.75418995	-18.27661	16.43991649	83.948745	-5.466542613	46.58774
47.50	-3.251596298	-33.326125	-39.78187761	-18.910405	16.17553549	80.641235	-5.329160876	23.259285
47.60	-3.268054877	-35.69965	-40.50175647	-16.494985	15.83062305	76.59213	-5.331730337	-10.817795
47.70	-3.197709514	-38.40512	-39.84151417	-23.96488	15.55138808	72.40707	-5.112255024	-44.44834
47.80	-3.088946199	-40.00957	-39.74344525	-24.20002	15.44655529	69.826985	-4.986999644	-65.87223
47.90	-3.040911757	-42.27745	-40.16362967	-26.65217	15.06404028	65.32746	-5.064122553	-99.53182
48.00	-3.172527326	-44.466625	-40.0365675	-27.08356	14.6352694	61.57372	-4.795123718	-133.38095
48.10	-3.150830361	-45.39024	-39.89605428	-24.263	14.4527404	59.16333	-4.65142505	-145.94615
48.20	-2.993930827	-47.519715	-39.93646868	-20.028135	14.18701164	55.34517	-4.641333567	45.902825
48.30	-3.000920183	-50.075945	-39.37902389	-23.23876	13.83540116	50.94918	-4.448451081	137.0523
48.40	-3.11732891	-51.44943	-38.89215091	-23.00484	13.54105487	48.32242	-4.371152801	114.2583
48.50	-3.061740416	-52.90041	-38.24573877	-23.237385	13.24768434	45.0734	-4.439588235	80.36621
48.60	-2.892471885	-53.920435	-37.15975026	-17.17688	12.84345769	42.14235	-4.543362185	48.153695
48.70	-2.977134607	-56.53239	-37.29989991	-23.316975	12.63886194	38.641175	-4.415762559	26.62829
48.80	-3.199672367	-58.56358	-37.45991113	-26.12011	12.23483422	34.57153	-4.230971749	-7.4064585
48.90	-3.41494799	-59.858015	-37.56980516	-21.729685	11.7596177	31.66616	-4.112980055	-40.51157
49.00	-3.112059564	-61.74711	-37.63302879	-24.721685	11.58292086	28.950185	-4.183002459	-62.724355
49.10	-2.956051777	-63.223905	-38.13373199	-34.083085	11.30137078	25.71588	-4.252655885	-96.15791
49.20	-3.057361141	-63.873	-37.70054876	-40.067215	10.85029624	21.905875	-3.954961949	-128.35225
49.30	-3.129729307	-64.317025	-37.52419947	-34.084005	10.54038106	20.34372	-3.839086791	-141.72935
49.40	-3.031480778	-66.864425	-37.56057142	-23.231605	10.25204619	17.55355	-3.95096073	51.100465
49.50	-3.133126679	-68.956585	-37.24372528	-27.48876	9.868855119	14.226365	-3.725805105	143.86085
49.60	-3.107716946	-70.454495	-36.85700185	-28.126895	9.66575816	11.779845	-3.763575802	121.4613
49.70	-3.222350697	-72.221275	-37.11237382	-28.060635	9.23191551	8.121475	-3.728433319	89.27365
49.80	-3.092430004	-72.637985	-34.99176101	-24.273975	8.932499558	5.112267	-3.469519493	56.08961
49.90	-3.021109485	-73.275885	-35.17795964	-21.29544	8.741331813	3.3894285	-3.476473707	34.508585
50.00	-3.021109485	-73.275885	-35.17795964	-21.29544	8.741331813	3.3894285	-3.476473707	34.508585

7

MACOM Technology Solutions Inc. (MACOM) and its affiliates reserve the right to make changes to the product(s) or information contained herein without notice.
Visit www.macom.com for additional data sheets and product information.

For further information and support please visit:
<https://www.macom.com/support>

Buffer Amplifier 35 - 45 GHz

Rev. V1

S-Parameters (cont.)

Typical S-Parameter Data for XB1005
Vd=4.5 V Id1=28 mA Id2=42 mA Id3=84 mA

Frequency (GHz)	S11 Mag dB	S11 Phase Ang°	S12 Mag dB	S12 Phase Ang°	S21 Mag dB	S21 Phase Ang°	S22 Mag dB	S22 Phase Ang°
35.00	-5.013649968	96.86269	-50.47357126	70.0204	23.28663777	148.3632	-26.23974953	-50.44486
35.10	-5.013649968	96.86269	-50.47357126	70.0204	23.28663777	148.3632	-26.23974953	-50.44486
35.20	-5.405151726	95.12973	-51.05630377	68.94866	23.41743755	144.71	-25.43012419	54.22047
35.30	-6.034904863	93.03825	-50.63372721	68.85207	23.57264488	139.5169	-25.00729738	123.1456
35.40	-6.560192335	91.43363	-51.20414432	57.14345	23.75595008	134.1657	-23.82961802	86.1783
35.50	-6.871140172	89.74764	-52.6155881	57.20356	23.79745735	130.3188	-23.34608159	55.60579
35.60	-7.695252406	87.49335	-52.66585708	65.59249	23.81997192	125.3463	-23.06816114	22.1133
35.70	-8.351910065	86.91677	-52.90565048	62.49314	23.96328432	120.1368	-22.1569464	-15.11358
35.80	-8.761424562	86.01883	-53.277231	58.15002	23.97519997	116.4005	-21.85285684	-39.24678
35.90	-9.436154216	84.46066	-54.68521269	63.67553	23.90725981	111.1573	-21.28865443	-80.22083
36.00	-10.42394939	83.55932	-54.2287702	76.11398	23.86936124	106.8656	-21.42157994	-113.7172
36.10	-11.03387999	83.63251	-54.40752401	73.21515	23.88221865	103.7611	-21.08324618	-133.5756
36.20	-11.92200424	84.14343	-54.02704722	80.2463	23.84843676	99.01727	-20.79500939	-45.29256
36.30	-12.8538423	86.79258	-52.75186437	76.82505	23.81400121	94.50258	-20.94643089	146.0876
36.40	-13.20443955	88.77908	-53.41277626	70.51764	23.75271134	91.65539	-20.99688589	132.8135
36.50	-14.11920367	90.81744	-53.51735372	71.01715	23.72399745	87.73048	-20.76463382	101.9512
36.60	-14.83931157	93.76892	-54.56629804	71.46447	23.64897507	83.26331	-20.38518769	64.73998
36.70	-15.4995179	96.42546	-53.49356769	85.09204	23.58309717	80.55062	-20.88966229	44.66191
36.80	-16.32822006	105.1218	-52.37879236	84.26089	23.52176683	76.76583	-20.53654393	16.03737
36.90	-16.43250159	110.2887	-53.82721693	83.15356	23.45129179	72.98928	-20.63160879	-17.89317
37.00	-16.90060055	114.9508	-53.46656152	91.89145	23.42159778	70.65491	-20.66906485	-37.7862
37.10	-16.73501679	125.4232	-51.93341074	90.97401	23.42381451	66.99868	-20.03426634	-67.91788
37.20	-16.38546972	129.4294	-52.55260776	85.67867	23.37834005	63.07662	-19.66257464	-100.2427
37.30	-16.12734375	132.9656	-52.53662236	87.0153	23.35712133	60.68582	-19.63055944	-118.4544
37.40	-15.58581618	136.94	-51.98043222	89.39064	23.32638054	57.02566	-19.28788955	-143.4697
37.50	-14.67101591	140.2196	-51.87711898	83.72266	23.31116882	53.15914	-18.97857173	46.8621
37.60	-14.39511086	139.4543	-52.74969878	81.72641	23.25022101	50.57388	-18.77915581	138.4679
37.70	-14.06545568	141.5876	-52.99957284	84.585	23.19625331	47.21034	-18.57200906	119.3338
37.80	-13.51889178	143.7496	-52.80591431	96.87878	23.15886736	43.82421	-18.82536807	88.07093
37.90	-13.21367294	144.0262	-51.71638054	100.8984	23.17199797	41.6006	-18.63951187	69.42745
38.00	-12.71393221	143.1827	-51.77932162	95.15831	23.14878248	37.87995	-18.12299236	34.71025
38.10	-12.42201588	142.207	-51.2348302	103.1601	23.08027485	34.43594	-18.18422415	1.865846
38.20	-12.17091326	142.7086	-50.14893347	106.9054	23.0657658	32.40521	-18.0050416	-18.59906
38.30	-11.90892246	142.0679	-49.14169738	102.6875	23.02927734	28.79849	-17.3629573	-50.91554
38.40	-11.7024208	141.5405	-48.94376804	103.3028	22.96501792	25.69558	-17.59870785	-85.2709
38.50	-11.50069803	142.2515	-48.3221119	103.8884	22.96701441	23.81939	-17.71541594	-104.7494
38.60	-10.84251837	143.0725	-46.80823004	99.11844	23.05099748	20.55066	-17.28011968	-134.1577
38.70	-10.45284022	139.3101	-46.70849132	87.95623	23.00643817	16.52645	-16.30840571	-43.78952
38.80	-10.32023093	137.72	-47.01108215	83.64708	22.95707171	14.21117	-16.05446377	123.5317
38.90	-10.20790667	135.843	-46.98323549	80.02343	22.8739975	10.76335	-15.85150661	132.2833
39.00	-9.897776861	134.1158	-46.55620449	74.37585	22.83694463	7.466306	-15.66791349	98.47626
39.10	-9.731224219	131.5676	-46.51109216	66.03019	22.78498452	5.303127	-15.43980984	74.56831
39.20	-9.880747114	129.5742	-48.41369474	61.2695	22.70568594	2.593611	-15.86107813	38.09513
39.30	-9.677939735	129.7244	-48.27008094	65.81956	22.71920974	-0.4646489	-15.98272526	7.173865
39.40	-9.548015199	127.1936	-48.04325452	60.03984	22.68230789	-2.614533	-15.81130775	-15.02281
39.50	-9.55700119	125.5843	-49.15402948	53.59853	22.69651359	-5.62726	-16.1613233	-49.95332
39.60	-9.467165873	123.0737	-49.94811892	52.81193	22.71327258	-9.065343	-16.01618847	-80.73511
39.70	-9.529692874	121.5859	-50.08794617	53.55812	22.65599575	-11.00631	-15.91186986	-103.2098
39.80	-9.661619001	121.0674	-50.88530878	48.60514	22.6258587	-13.80386	-15.78292584	-135.9833
39.90	-9.44771907	119.3197	-51.14063464	42.50964	22.63027148	-16.87973	-15.75281966	-45.99078
40.00	-9.472656635	118.5734	-51.43225879	34.60629	22.640897	-18.65331	-16.20806776	122.4499
40.10	-9.336941141	118.5538	-50.4123717	73.05424	22.69173221	-21.799	-16.40238244	137.0342
40.20	-9.043661464	115.9205	-49.95813989	65.99443	22.69077925	-24.99456	-16.19342337	105.1232
40.30	-9.010975199	114.0868	-50.51739968	58.96918	22.71064066	-27.17887	-16.20628685	82.7605
40.40	-8.932677014	111.4643	-50.99968279	58.1738	22.69621736	-30.79142	-16.02584311	51.83532
40.50	-8.941247829	110.1712	-52.13950388	64.60454	22.62431111	-33.96268	-16.17478349	15.84822
40.60	-8.820435027	109.6106	-51.55190881	76.226	22.61468043	-35.83163	-16.45394714	-5.179981
40.70	-8.612627858	107.4951	-50.08660388	88.94391	22.66736428	-38.92984	-16.48066732	-35.35193
40.80	-8.556303492	104.9018	-49.76100466	85.50819	22.66211726	-42.29356	-16.14335042	-67.20477
40.90	-8.584215293	103.8071	-49.91541355	84.55574	22.61015595	-44.30212	-16.10139205	-89.9345
41.00	-8.616593695	101.8407	-49.83505546	85.75831	22.62947073	-46.95596	-16.07522975	-123.7465
41.10	-8.562282328	101.0239	-48.59599462	89.79264	22.75068856	-50.23732	-16.4043071	-146.0694
41.20	-8.419296977	99.67204	-47.40880177	92.59733	22.76192262	-52.68517	-16.11262776	-49.33684
41.30	-8.329228631	97.06203	-47.33376631	83.64501	22.70298407	-56.18497	-15.86156569	139.5542
41.40	-8.294571348	95.01467	-47.58600198	85.38848	22.67445988	-59.25742	-16.07160501	117.0752
41.50	-8.220618594	93.72849	-47.128809	89.17581	22.70534092	-61.45634	-15.90642795	97.37801
41.60	-8.095526549	92.12522	-45.80502933	85.62588	22.71924015	-65.1273	-15.10905507	62.21435
41.70	-8.033050328	89.02106	-45.49025942	79.6627	22.64976188	-68.42216	-15.01149542	24.503
41.80	-8.014688132	86.98921	-45.01711218	76.05447	22.59158689	-70.32471	-15.19609489	-0.8175696
41.90	-8.099919715	84.88252	-45.20396697	70.90907	22.60221789	-72.90405	-15.444079928	-35.66336
42.00	-8.057790013	82.75429	-45.02212931	64.6249	22.67618031	-75.90685	-15.5330116	-72.20084
42.10	-8.009858167	80.58789	-44.90575067	61.84267	22.68296627	-78.17215	-15.66852274	-94.49482
42.20	-8.105104994	77.41656	-44.91746009	51.95074	22.6964633	-81.28886	-15.86110116	-128.9069
42.30	-8.234614659	76.16174	-45.91578265	46.88808	22.76595367	-84.23895	-16.43226203	-121.5491
42.40	-8.225578873	74.90749	-45.97819254	47.98088	22.78185619	-86.66268	-16.58366635	49.05499
42.50	-8.39660762	72.69305	-45.91009974	43.44286	22.79852264	-89.75367	-16.51068492	137.769
42.60	-8.402792003	72.00087	-46.1364918	44.00193	22.85308536	-93.33629	-16.88805394	105.0244
42.70	-8.34007225	70.45168	-46.19754456	45.92479	22.90432079	-95.64658	-17.06058082	82.20164
42.80	-8.273874681	67.60483	-46.27303304	46.88006	22.90636264	-99.39616	-17.02657142	48.85906
42.90	-8.337293867	65.21482	-45.99784714	43.23265	22.81847233	-102.9355	-16.84023026	15.08559

Buffer Amplifier 35 - 45 GHz

Rev. V1

S-Parameters (cont.)

Typical S-Parameter Data for XB1005 (cont'd)
Vd=4.5 V Id1=28 mA Id2=42 mA Id3=84 mA

Frequency (GHz)	S11 Mag dB	S11 Phase Ang°	S12 Mag dB	S12 Phase Ang°	S21 Mag dB	S21 Phase Ang°	S22 Mag dB	S22 Phase Ang°
43.00	-8.466191741	63.93494	-46.01375049	41.73338	22.81158206	-104.7737	-16.49814505	-9.974573
43.10	-8.532810012	63.47232	-45.59273246	30.93189	22.89943992	-107.7251	-16.60740051	-49.54955
43.20	-8.3973384	62.41927	-46.66111736	32.53479	22.92860454	-111.2867	-17.01981045	-87.48149
43.30	-8.385784424	60.70901	-46.39034871	33.13986	22.98214357	-113.5373	-17.18763243	-112.6051
43.40	-8.437008719	58.97758	-46.8278307	33.45576	23.02877657	-117.1981	-17.49149892	-139.2157
43.50	-8.30843358	58.02209	-46.58109533	32.18636	23.0722674	-121.0676	-18.09978377	46.57008
43.60	-8.095959846	56.95599	-47.10086727	35.49992	23.06695073	-123.4921	-18.3841648	138.026
43.70	-8.105489095	55.12431	-46.92730032	38.26872	22.94948102	-127.0333	-18.00612515	121.9364
43.80	-7.956469522	53.9555	-47.6158863	34.19976	22.92697722	-130.0721	-17.77093887	86.24265
43.90	-7.771504208	52.61454	-48.00877971	35.60292	22.96084663	-132.1978	-18.05076096	59.21626
44.00	-7.493503899	49.88718	-47.95327667	36.95623	23.04149269	-135.4043	-18.13288396	23.31439
44.10	-7.579303582	47.36298	-47.28205888	40.53094	23.12761099	-138.7938	-18.10740149	-15.22874
44.20	-7.677475519	47.13729	-47.14027776	36.03515	23.14487971	-141.6755	-18.55344942	-39.1465
44.30	-7.362112151	46.71518	-48.11750772	39.2082	23.15737217	-145.8058	-19.07285459	-71.54464
44.40	-7.084036026	43.57927	-47.34567108	46.61612	23.19207951	-149.6803	-18.58186027	-103.0209
44.50	-7.01041237	42.19428	-46.82265946	49.1568	23.18841314	-152.523	-18.5581816	-126.3219
44.60	-6.90490295	40.46888	-46.66339316	52.96799	23.09860908	-155.9234	-17.84921719	-117.4898
44.70	-6.687306621	38.3066	-46.69970739	52.20012	23.11711436	-159.4528	-17.41067396	118.9883
44.80	-6.568603622	36.51917	-46.54704933	66.11798	23.14889682	-161.7395	-16.8238984	141.0049
44.90	-6.408044753	33.9311	-45.01605287	66.34527	23.19335772	-165.514	-15.84059737	108.4459
45.00	-6.353980612	32.28119	-44.67098019	54.03614	23.11611212	-169.3823	-15.57202114	72.84817
45.10	-6.17199559	30.97268	-44.93505712	51.07904	23.12717616	-170.2946	-14.78789827	50.07226
45.20	-6.115942981	27.78769	-44.17944359	47.17432	23.2789913	-167.8274	-13.74330367	8.986702
45.30	-6.043008059	25.58669	-44.25665463	42.256	23.35869995	52.74151	-13.90788589	-29.87931
45.40	-6.017377694	23.44832	-44.08677773	42.15673	23.34949572	165.578	-13.91357654	-53.10582
45.50	-5.919791776	23.36409	-43.36077548	34.00962	23.20551129	169.6145	-14.20924278	-91.54504
45.60	-5.578524567	21.46825	-43.08505267	32.60976	23.12015941	166.4463	-14.26072657	-122.0729
45.70	-5.43020021	20.00783	-43.47293989	32.68329	23.08753893	163.6702	-14.15030921	-139.6382
45.80	-5.227056741	17.01211	-43.76607298	36.92588	23.01247237	159.0496	-13.59895561	-47.8956
45.90	-5.0649231	14.92097	-42.69114252	36.46797	22.86117392	154.8265	-13.38986527	142.3569
46.00	-4.977856045	14.23545	-42.64581755	34.97142	22.78261487	152.514	-13.06321199	128.5334
46.10	-4.861647008	11.37255	-42.36742169	35.89629	22.76845193	148.8311	-12.2873598	96.66484
46.20	-4.809729266	8.370364	-41.3968359	30.32811	22.78132313	143.7889	-11.39217156	58.28918
46.30	-4.656190999	7.074264	-42.14098821	27.59449	22.70552256	140.7262	-11.11008556	34.40845
46.40	-4.537576293	5.15485	-41.89109789	21.00613	22.5493722	136.24	-10.83128251	-1.283124
46.50	-4.147107489	2.068134	-41.7446667	16.83405	22.53340376	131.4028	-10.64445248	-36.00452
46.60	-4.018907499	-0.27889	-42.38001179	14.20166	22.42173752	127.8261	-10.6435055	-59.1283
46.70	-4.073237724	-2.806079	-41.99072626	10.74911	22.19995815	122.8935	-10.36266742	-91.05585
46.80	-3.806720859	-4.831432	-42.15300187	10.52681	22.11171052	118.8167	-9.775766919	-124.4382
46.90	-3.620253764	-6.159395	-42.38817495	9.973029	22.05049856	116.1942	-9.506493181	-143.0288
47.00	-3.42858048	-9.655697	-42.02322644	7.785538	21.93577029	111.3829	-8.956796184	-47.87313
47.10	-3.445367386	-12.25358	-41.01781669	13.1285	21.71875813	106.0672	-8.825092784	137.9415
47.20	-3.320606367	-13.16131	-40.43116903	8.797885	21.54780852	103.5128	-8.799939199	120.6292
47.30	-3.115104038	-15.61146	-40.63953958	3.239813	21.4397123	99.51881	-8.542907823	87.30853
47.40	-3.16466777	-19.4584	-40.67547203	-0.8227057	21.21285222	94.47631	-8.004303789	53.84463
47.50	-3.165509709	-21.07638	-40.59233936	-1.921903	20.99254559	91.02259	-7.745996347	30.17902
47.60	-3.133735135	-23.38498	-41.2734237	-0.0984054	20.67863412	86.61945	-7.756292803	-4.936145
47.70	-3.010784707	-26.45991	-40.75545924	-7.50477	20.45322751	82.15114	-7.456123578	-38.16262
47.80	-2.881585614	-28.34643	-40.61317082	-6.403759	20.38045077	79.35125	-7.2376249	-59.35592
47.90	-2.772432645	-30.80593	-40.9407643	-13.2162	20.04244439	74.67693	-7.266033965	-92.68143
48.00	-2.868742271	-33.38657	-40.56467689	-9.263591	19.66284945	70.47761	-6.850114378	-126.6312
48.10	-2.827230211	-34.45126	-40.27609624	-5.430867	19.50040573	67.76733	-6.6254425	-141.863
48.20	-2.642132659	-36.78955	-40.31520025	-8.518817	19.26729983	63.61612	-6.530270985	49.56387
48.30	-2.608161861	-39.64372	-39.64195248	-9.849635	18.94581066	58.84941	-6.313525973	141.5602
48.40	-2.695040833	-41.36377	-39.08220503	-12.92418	18.67838598	55.94135	-6.202247863	120.1079
48.50	-2.652836472	-43.11937	-38.47253886	-9.44034	18.39026271	52.13172	-6.176806916	85.82643
48.60	-2.468756082	-44.2821	-37.36200157	-8.79037	17.98358514	48.98932	-6.281051365	53.61549
48.70	-2.515583517	-47.1987	-37.37192489	-12.42549	17.80311175	45.22096	-6.121823887	32.30106
48.80	-2.712477122	-49.4547	-37.72641836	-16.98318	17.40429895	40.89746	-5.855151202	-1.816883
48.90	-2.922953111	-50.96608	-37.70207636	-12.23584	16.93570979	37.64836	-5.689345329	-35.08606
49.00	-2.615840867	-53.0897	-37.81972708	-13.90446	16.78142681	34.65386	-5.72842207	-57.12588
49.10	-2.446688787	-54.70441	-38.34801661	-23.30115	16.50404293	31.30288	-5.73703444	-90.52146
49.20	-2.50096114	-55.83318	-38.00668178	-31.237	16.08267577	27.09127	-5.296762657	-122.6663
49.30	-2.567746873	-56.57803	-37.62001934	-29.55196	15.77792003	25.20954	-5.13062705	-143.8559
49.40	-2.509356278	-59.15225	-37.72079215	-19.6743	15.45852985	22.15488	-5.224764603	-51.1178
49.50	-2.599529494	-61.19781	-37.24983239	-20.91034	15.04709833	18.61195	-4.983526698	140.9411
49.60	-2.558497569	-62.7948	-36.83574058	-23.78484	14.8456312	16.07037	-4.981221921	126.1345
49.70	-2.6550585	-64.86092	-37.0079248	-22.62072	14.40611894	12.14211	-4.908845652	93.7889
49.80	-2.509700169	-65.71354	-35.16219098	-15.76751	14.11064988	8.821751	-4.592613571	60.47185
49.90	-2.449882181	-66.52166	-35.14038168	-13.62498	13.89820763	6.90788	-4.583266784	38.67072
50.00	-2.449882181	-66.52166	-35.14038168	-13.62498	13.89820763	6.90788	-4.583266784	38.67072

9

MACOM Technology Solutions Inc. (MACOM) and its affiliates reserve the right to make changes to the product(s) or information contained herein without notice.
Visit www.macom.com for additional data sheets and product information.

For further information and support please visit:
<https://www.macom.com/support>

Mechanical Drawing

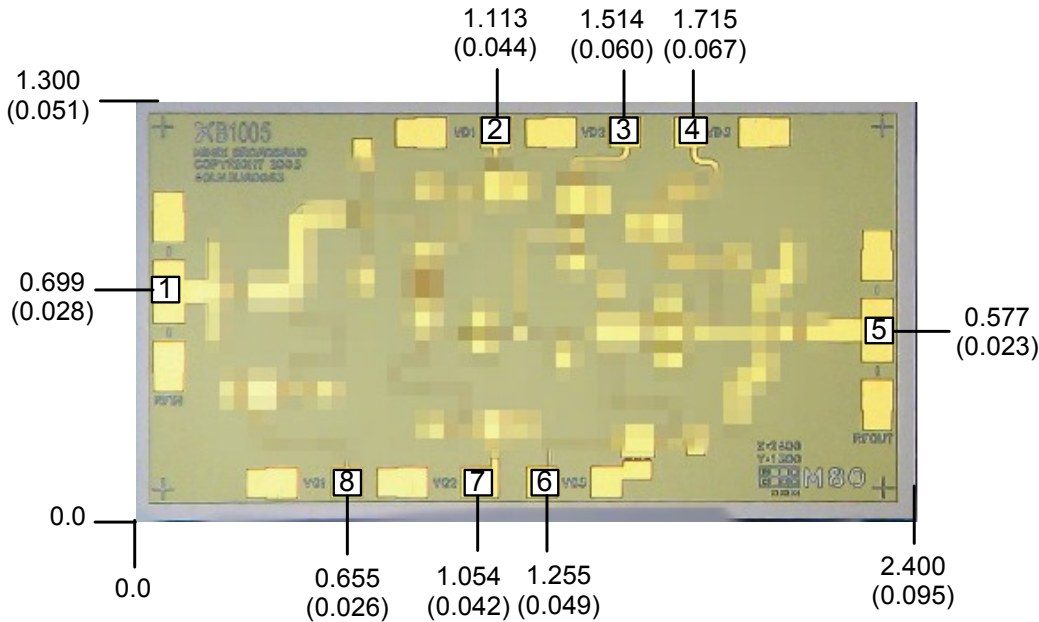

(Note: Engineering designator is 40LN3UA0063)

Units: millimeters (inches) Bond pad dimensions are shown to center of bond pad.
 Thickness: 0.110 +/- 0.010 (0.0043 +/- 0.0004), Backside is ground, Bond Pad/Backside Metallization: Gold
 All DC Bond Pads are 0.100 x 0.100 (0.004 x 0.004). All RF Bond Pads are 0.100 x 0.200 (0.004 x 0.008)
 Bond pad centers are approximately 0.109 (0.004) from the edge of the chip.
 Dicing tolerance: +/- 0.005 (+/- 0.0002). Approximate weight: 1.931 mg.

Bond Pad #1 (RF In)	Bond Pad #3 (Vd2)	Bond Pad #5 (RF Out)	Bond Pad #7 (Vg2)
Bond Pad #2 (Vd1)	Bond Pad #4 (Vd3)	Bond Pad #6 (Vg3)	Bond Pad #8 (Vg1)

Bias Arrangement

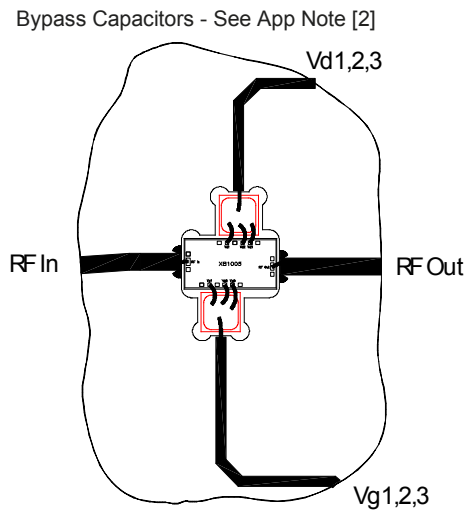
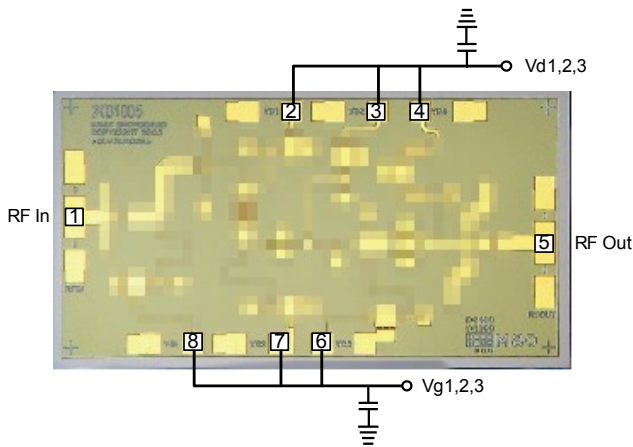

MTTF Tables

These numbers were calculated based on accelerated life test information and thermal model analysis received from the fabricating foundry.

Backplate Temperature	Channel Temperature	Rth	MTTF Hours	FITs
55 deg Celsius	82.9 deg Celsius	159.3° C/W	8.36E+10	1.20E-02
75 deg Celsius	105.0 deg Celsius	171.3° C/W	5.382E+09	1.86E-01
95 deg Celsius	126.8 deg Celsius	182.0° C/W	4.796E+08	2.09E+00

Bias Conditions: Vd1=Vd2=Vd3=3.5 V, Id1=9 mA, Id2=16 mA, Id3=25 mA

Backplate Temperature	Channel Temperature	Rth	MTTF Hours	FITs
55 deg Celsius	157.3 deg Celsius	147.6° C/W	3.00E+07	3.34E+01
75 deg Celsius	184.0 deg Celsius	157.3° C/W	3.07E+06	3.26E+02
95 deg Celsius	210.1 deg Celsius	166.1° C/W	4.21E+05	2.37E+03

Bias Conditions: Vd1=Vd2=Vd3=4.5 V, Id1=28 mA, Id2=42 mA, Id3=84 mA

App Note [1] Biasing - As shown in the bonding diagram, this device can be operated with all three stages in parallel, and can be biased for low noise performance or high power performance. Low noise bias is nominally Vd=3.5V, Id=50mA. More controlled performance will be obtained by separately biasing Vd1, Vd2 and Vd3 each at 3.5V, with Id1=9mA, Id2=16mA, Id3=25mA. Power bias may be as high as Vd=4.5V, Id=154mA with all stages in parallel, or most controlled performance will be obtained by separately biasing Vd1, Vd2 and Vd3 each at 4.5V, with Id1=28mA, Id2=42mA, Id3=84mA. It is also recommended to use active biasing to keep the currents constant as the RF power and temperature vary; this gives the most reproducible results. Depending on the supply voltage available and the power dissipation constraints, the bias circuit may be a single transistor or a low power operational amplifier, with a low value resistor in series with the drain supply used to sense the current. The gate of the pHEMT is controlled to maintain correct drain current and thus drain voltage. The typical gate voltage needed to do this is -0.4V. Typically the gate is protected with Silicon diodes to limit the applied voltage. Also, make sure to sequence the applied voltage to ensure negative gate bias is available before applying the positive drain supply.

App Note [2] Bias Arrangement -

For Parallel Stage Bias (Recommended for general applications) -- The same as Individual Stage Bias but all the drain or gate pad DC bypass capacitors (~100-200 pf) can be combined. Additional DC bypass capacitance (~0.01 uF) is also recommended to all DC or combination (if gate or drains are tied together) of DC bias pads.

For Individual Stage Bias (Recommended for Saturated Applications) -- Each DC pad (Vd1,2,3 and Vg1,2,3) needs to have DC bypass capacitance (~100-200 pf) as close to the device as possible. Additional DC bypass capacitance (~0.01 uF) is also recommended.

Device Schematic

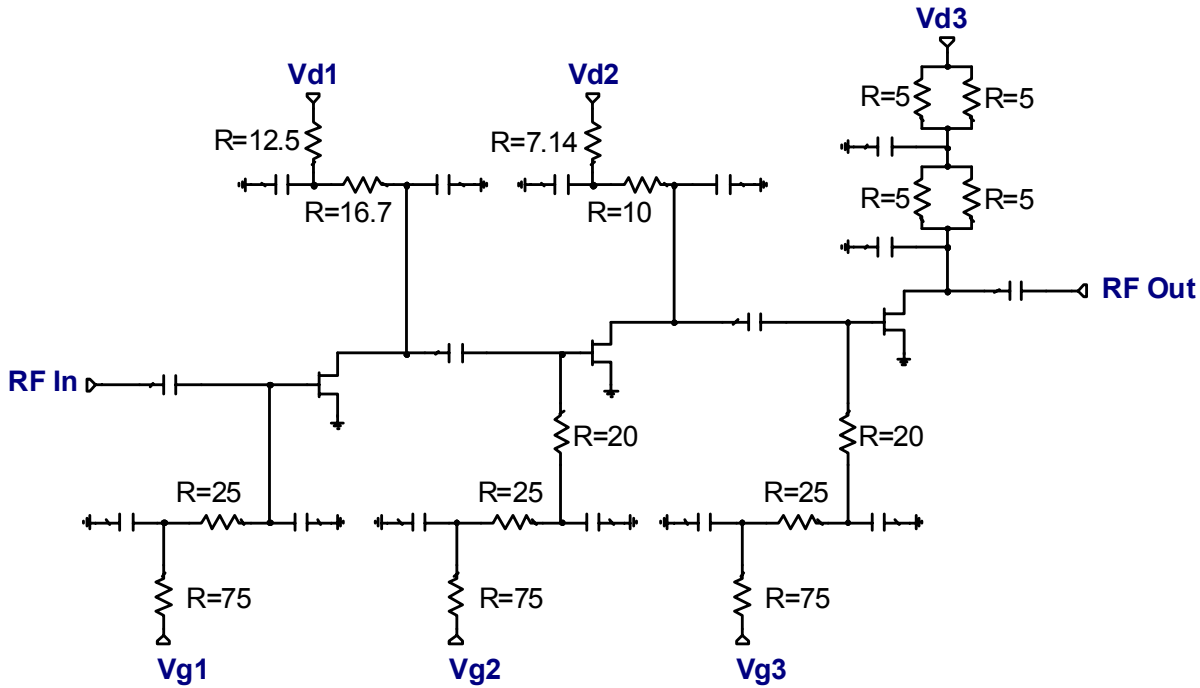

Typical Application

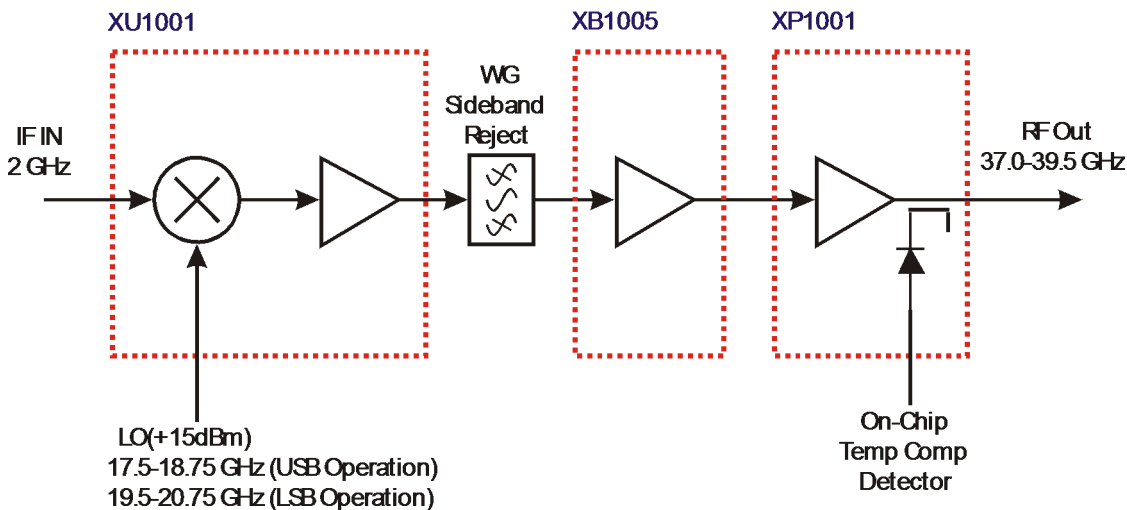

M/A-COM Tech MMIC-based 36.0-40.0 GHz Transmitter Block Diagram
(Changing LO and IF frequencies as required allows design to operate as high as 40 GHz)

M/A-COM Technology Solutions Inc. All rights reserved.

Information in this document is provided in connection with M/A-COM Technology Solutions Inc ("MACOM") products. These materials are provided by MACOM as a service to its customers and may be used for informational purposes only. Except as provided in MACOM's Terms and Conditions of Sale for such products or in any separate agreement related to this document, MACOM assumes no liability whatsoever. MACOM assumes no responsibility for errors or omissions in these materials. MACOM may make changes to specifications and product descriptions at any time, without notice. MACOM makes no commitment to update the information and shall have no responsibility whatsoever for conflicts or incompatibilities arising from future changes to its specifications and product descriptions. No license, express or implied, by estoppel or otherwise, to any intellectual property rights is granted by this document.

THESE MATERIALS ARE PROVIDED "AS IS" WITHOUT WARRANTY OF ANY KIND, EITHER EXPRESS OR IMPLIED, RELATING TO SALE AND/OR USE OF MACOM PRODUCTS INCLUDING LIABILITY OR WARRANTIES RELATING TO FITNESS FOR A PARTICULAR PURPOSE, CONSEQUENTIAL OR INCIDENTAL DAMAGES, MERCHANTABILITY, OR INFRINGEMENT OF ANY PATENT, COPYRIGHT OR OTHER INTELLECTUAL PROPERTY RIGHT. MACOM FURTHER DOES NOT WARRANT THE ACCURACY OR COMPLETENESS OF THE INFORMATION, TEXT, GRAPHICS OR OTHER ITEMS CONTAINED WITHIN THESE MATERIALS. MACOM SHALL NOT BE LIABLE FOR ANY SPECIAL, INDIRECT, INCIDENTAL, OR CONSEQUENTIAL DAMAGES, INCLUDING WITHOUT LIMITATION, LOST REVENUES OR LOST PROFITS, WHICH MAY RESULT FROM THE USE OF THESE MATERIALS.

MACOM products are not intended for use in medical, lifesaving or life sustaining applications. MACOM customers using or selling MACOM products for use in such applications do so at their own risk and agree to fully indemnify MACOM for any damages resulting from such improper use or sale.

Mouser Electronics

Authorized Distributor

Click to View Pricing, Inventory, Delivery & Lifecycle Information:

MACOM:

[XB1005-BD-000V](#) [XB1005-BD-EV1](#)