

# **BLE112**

DATA SHEET

Wednesday, 02 December 2020

Version 1.8



Not Recommended for New Designs

## VERSION HISTORY

Version	Comment
1.0	Certification information updated. Layout guide for BLE112-N added.
1.1	RF pin dimensions added
1.11	Absolute maximum supply corrected
1.2	Certification information updated
1.21	Current consumption added
1.22	Current consumption profiles added
1.23	Typo corrected on table 2
1.24	UART chapter, I/O Ports chapter, DC characteristics
1.25	Updated product codes
1.26	Note about P1_0 and P1_1 in chapter 2.1
1.27	Design check list, peripheral pull-up/pull-down requirements
1.28	Updating "Alternate" configuration table for clarity
1.29	Absolute maximum ratings: all supply nets must have the same voltage. Opamp and comparator removed from the peripherals table.
1.3	MIC Japan information updated
1.4	Updated contact information
1.41	CE info updated
1.42	TXP vs HW config added
1.43	Peripheral mapping table: analog comparator added
1.44	Product codes updates
1.45	CE info updated
1.46	Layout examples added

1.47	Contact info updated
1.48	Updated op-amp description
1.49	Recommended stencil thickness updated
1.50	Updated description of encryption modes.
1.6	Added tape and reel information
1.7	Updated certification information
1.8	Renamed "Bluetooth Smart" to "Bluetooth Low Energy" according to the official Bluetooth SIG nomenclature

Not Recommended for New Designs

## TABLE OF CONTENTS

1	BLE112 Product numbering .....	6
2	Pinout and Terminal Description .....	7
2.1	I/O Ports .....	10
2.2	UART .....	10
2.3	Electrical Characteristics .....	11
2.4	Absolute Maximum Ratings .....	11
2.5	Recommended Operating Conditions .....	11
2.6	DC Characteristics .....	11
2.7	Current Consumption .....	12
2.8	RF Characteristics .....	13
2.8.1	TX Power vs HW Configuration .....	13
2.8.2	Antenna characteristics .....	13
3	Physical Dimensions .....	16
4	Power-On Reset and Brownout Detector .....	18
5	Design Guidelines .....	19
5.1	General Design Guidelines .....	19
5.2	Layout Guide Lines .....	20
5.3	BLE112-A Layout Guide .....	20
5.4	BLE112-N Layout Guide .....	21
5.5	Design Check List .....	23
6	Soldering Recommendations .....	24
7	Block diagram .....	25
8	Certifications .....	28
8.1	Bluetooth .....	28
8.2	FCC and IC .....	28
8.2.1	FCC et IC .....	29
8.3	CE .....	31
8.4	MIC Japan .....	31
8.5	KCC (Korea) .....	31
8.6	Anatel (Brazil) .....	31
8.7	NCC (Taiwan) .....	32
8.8	Qualified Antenna Types for BLE112-E and BLE112-N .....	33
9	Tape and reel information .....	34
10	Reel appearance and dimensions .....	35

## BLE112 *Bluetooth*® Low Energy single mode module

---

### DESCRIPTION

BLE112, *Bluetooth* Low Energy single mode module is a single mode device targeted for low power sensors and accessories.

BLE112 offers all *Bluetooth* Low Energy features: radio, stack, profiles and application space for customer applications, so no external processor is needed. The module also provides flexible hardware interfaces to connect sensors, simple user interfaces or even displays directly to the module.

BLE112 can be powered directly with a standard 3V coin cell batteries or pair of AAA batteries. In lowest power sleep mode it consumes only 400nA and will wake up in few hundred microseconds.

### APPLICATIONS:

- Heart rate sensors
- Pedometers
- Watches
- Blood pressure and glucose meters
- Weight scales
- Key fobs
- Households sensors and collector devices
- Security tags
- Wireless keys (keyless go)
- Proximity sensors
- HID keyboards and mice
- Indoor GPS broadcasting devices

### KEY FEATURES:

- *Bluetooth v.4.0*, single mode compliant
  - Supports master and slave modes
  - 4+ simultaneous connection in master mode
- Integrated *Bluetooth* Low Energy stack
  - GAP, GATT, L2CAP, SMP
  - *Bluetooth* Low Energy profiles
- Radio performance
  - TX power: +3dBm to -23dBm
  - RX sensitivity: -85dBm to -91dBm
- Ultra low current consumption
  - Transmit: 27mA (0dBm)
  - Sleep mode 3: 0.4uA
- Programmable 8051 processor for embedding full applications
- *Bluetooth* qualified
- CE qualified
- Modular certification for FCC, IC and KCC, Anatel and NCC
- MIC Japan compatibility fully tested with ARIB STD-T66



## 1 BLE112 Product numbering

Product code	Description
BLE112-A-v1	BLE112 with integrated chip antenna and software version 1.0
BLE112-E-v1	BLE112 with U.FL connector and software version 1.0

Not Recommended for New Designs

## 2 Pinout and Terminal Description

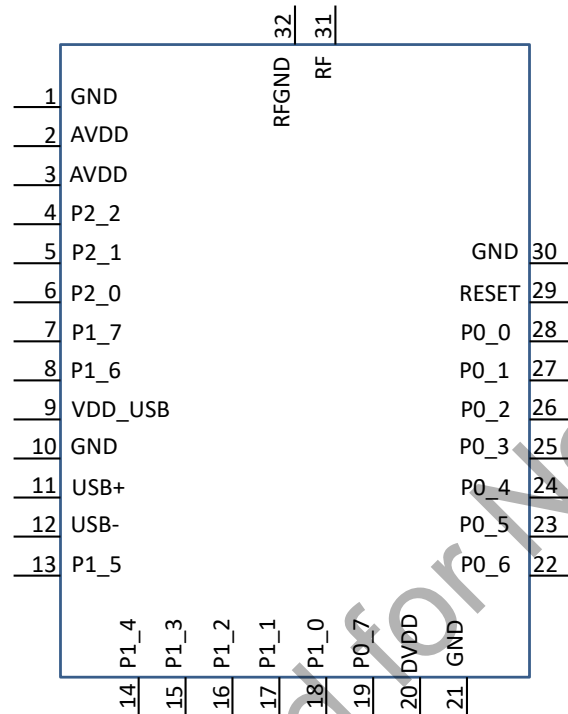

Figure 1: BLE112

	PIN NUMBER	PAD TYPE	DESCRIPTION
RESET	29		Active low reset.
GND	1, 10, 21, 30	GND	GND
RF	31	RF (*)	RF output/input for BLE112-N. With BLE112-A and BLE112-E do not connect.
RFGND	32	GND	RF ground. Connected to GND internally in the module. With BLE112-A and BLE112-E leave floating or connect to a solid GND plane.
DVDD	20	Supply voltage	Supply voltage 2V - 3.6V
AVDD	2, 3	Supply voltage	Supply voltage 2V - 3.6V
VDD_USB	9	Supply voltage	Supply voltage 2V - 3.6V

\*) RF pin is not connected in BLE112-A and BLE112-E. To use RF pin with BLE112-B please see the design guide.

Table 1: Supply and RF Terminal Descriptions

<b>PIN NUMBER</b>	<b>PIN NAME</b>	<b>PIN TYPE</b>	<b>DESCRIPTION</b>
4	P2_2	Digital I/O	Configurable I/O port, See table 3
5	P2_1	Digital I/O	Configurable I/O port, See table 3
6	P2_0	Digital I/O	Configurable I/O port, See table 3
7	P1_7	Digital I/O	Configurable I/O port, See table 3
8	P1_6	Digital I/O	Configurable I/O port, See table 3
11	USB+	USB+	USB data plus
12	USB-	USB-	USB data minus
13	P1_5	Digital I/O	Configurable I/O port, See table 3
14	P1_4	Digital I/O	Configurable I/O port, See table 3
15	P1_3	Digital I/O	Configurable I/O port, See table 3
16	P1_2	Digital I/O	Configurable I/O port, See table 3
17	P1_1	Digital I/O	Configurable I/O port with 20mA driving capability, See table 3
18	P1_0	Digital I/O	Configurable I/O port with 20mA driving capability, See table 3
19	P0_7	Digital I/O	Configurable I/O port, See table 3
22	P0_6	Digital I/O	Configurable I/O port, See table 3
23	P0_5	Digital I/O	Configurable I/O port, See table 3
24	P0_4	Digital I/O	Configurable I/O port, See table 3
25	P0_3	Digital I/O	Configurable I/O port, See table 3
26	P0_2	Digital I/O	Configurable I/O port, See table 3
27	P0_1	Digital I/O	Configurable I/O port, See table 3
28	P0_0	Digital I/O	Configurable I/O port, See table 3

**Table 2: Terminal Descriptions**

\*) BLE112 is configurable as either SPI master or SPI slave



PERIPHERAL / FUNCTION	P0								P1								P2			HARDWARE.XML Example (*)
	7	6	5	4	3	2	1	0	7	6	5	4	3	2	1	0	2	1	0	
Analog Comparator			+	-																(***)
ADC	A7	A6	A5	A4	A3	A2	A1	A0												(***)
USART 0 SPI (**)	Alt.1			C	SS	MO	MI													<usart channel="0" mode="spi_master" alternate="1" ...
	Alt.2										MO	MI	C	SS						<usart channel="0" mode="spi_master" alternate="2" ...
USART 0 UART	Alt.1			RT	CT	TX	RX													<usart channel="0" mode="uart" alternate="1" ...
	Alt.2										TX	RX	RT	CT						<usart channel="0" mode="uart" alternate="2" ...
USART 1 SPI (**)	Alt.1			MI	MO	C	SS													<usart channel="1" mode="spi_master" alternate="1" ...
	Alt.2								MI	MO	C	SS								<usart channel="1" mode="spi_master" alternate="2" ...
USART 1 UART	Alt.1			RX	TX	RT	CT													<usart channel="1" mode="uart" alternate="1" ...
	Alt.2								RX	TX	RT	CT								<usart channel="1" mode="uart" alternate="2" ...
TIMER 1	Alt.1		4	3	2	1	0													<timer index="1" alternate="1" ...
	Alt.2	3	4											0	1	2				<timer index="1" alternate="2" ...
TIMER 3	Alt.1											1	0							<timer index="3" alternate="1" ...
	Alt.2								1	0										<timer index="3" alternate="2" ...
TIMER 4	Alt.1														1	0				<timer index="4" alternate="1" ...
	Alt.2																		0	<timer index="4" alternate="2" ...
DEBUG																	DC	DD		
OBSSEL											5	4	3	2	1	0				

\*) Refer to Profile Toolkit Developer Guide for detailed settings

\*\*) SS is the slave select signal when BLE113 is set as SPI slave. When set as SPI master, any available I/O can be used as chip select signal of BLE113

\*\*\*) The analog comparator and the ADC will be turned on automatically when taken in use and the configuration is done using API (Application Programming Interface). Refer to Bluetooth Low Energy Software API Reference

**Table 3: Peripheral I/O Pin Mapping**

## 2.1 I/O Ports

Each I/O port, except pins P1\_0 and P1\_1, can be configured as an input with either internal pull-up or pull-down, or tri-state. Pull-down or pull-up can only be configured to whole port, not individual pins. Unused I/O pins should have defined level and not be floating. To avoid excessive leakage current P1\_0 and P1\_1 must be configured either as outputs or as inputs using external pull-up or pull-down resistors. See the Profile Toolkit developer guide for more information about the configuration. During reset the I/O pins are configured as inputs with pull-ups. P1\_0 and P1\_1 are inputs but do not have pull-up or pull-down.

The pins configured as peripheral I/O signals do not have pull-up/pull-down capability, even if the peripheral function is an input. In power modes PM1, PM2, and PM3, the I/O pins retain the I/O mode and output value (if applicable) that was set when PM1/PM2/PM3 was entered. All the IO's set as input must have an external pull-up or pull-down resistor to avoid excessive leakage current.

## 2.2 UART

UART baud rate can be configured up to 2 Mbps. See the Profile Toolkit developer guide for more information. Following table lists commonly used baud rates for BLE112

Baud rate (bps)	Error (%)
2400	0.14
4800	0.14
9600	0.14
14 400	0.03
19 200	0.14
28 800	0.03
38 400	0.14
57 600	0.03
76 800	0.14
115 200	0.03
230 400	0.03

Table 4: Commonly used baud rates for BLE112

## 2.3 Electrical Characteristics

## 2.4 Absolute Maximum Ratings

Note: These are absolute maximum ratings beyond which the module can be permanently damaged. These are not maximum operating conditions. The maximum recommended operating conditions are in the table 6.

Rating	Min	Max	Unit
Storage Temperature	-40	85	°C
AVDD, DVDD, VDD_USB (*)	-0.3	3.9	V
Other Terminal Voltages	VSS-0.4	VDD+0.4	V

\*) All supply nets must have the same voltage

Table 5: Absolute Maximum Ratings

## 2.5 Recommended Operating Conditions

Rating	Min	Max	Unit
Operating Temperature Range	-40	85	°C
AVDD, DVDD, VDD_USB (*)	2.0	3.6	V

\*) Supply voltage noise should be less than 10mVpp. Excessive noise at the supply voltage will reduce the RF performance.

Table 6: Recommended Operating Conditions

## 2.6 DC Characteristics

Parameter	Test Conditions	Min	Typ	Max	Unit
Logic-0 input voltage				0.5	V
Logic-1 input voltage		2.5			V
Logic-0 input current	Input equals 0V	-50		50	nA
Logic-1 input current	Input equals VDD	-50		50	nA
I/O pin pull-up and pull-down resistors			20		kΩ
Logic-0 output voltage, 4 mA pins	Output load 4 mA			0.5	V
Logic-1 output voltage, 4 mA pins	Output load 4 mA	2.4			V

For detailed I/O terminal characteristic and timings refer to the CC2540 datasheet available in (<http://www.ti.com/lit/ds/symlink/cc2540.pdf>)

## 2.7 Current Consumption

Power mode	Min	Typ	Max	Unit
Active mode TX 2 dBm			36	mA
Active mode TX -2 dBm			30	mA
Active mode TX -6 dBm			28	mA
Active mode RX			25	mA
Power mode 1		235		uA
Power mode 2		0.9		uA
Power mode 3		0.4		uA

Table 7: Current consumption of BLE112

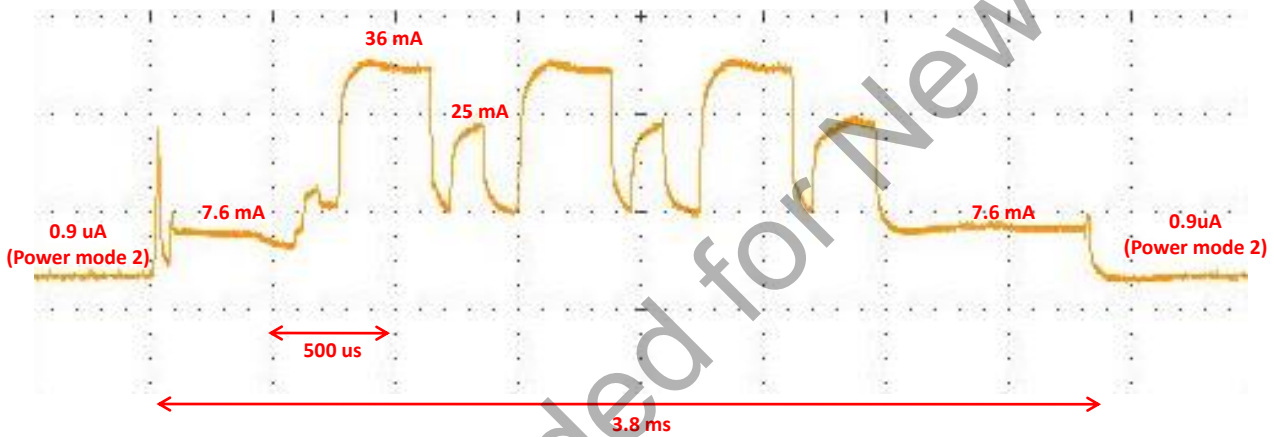

Figure 2: Typical current consumption profile during advertising in slave mode

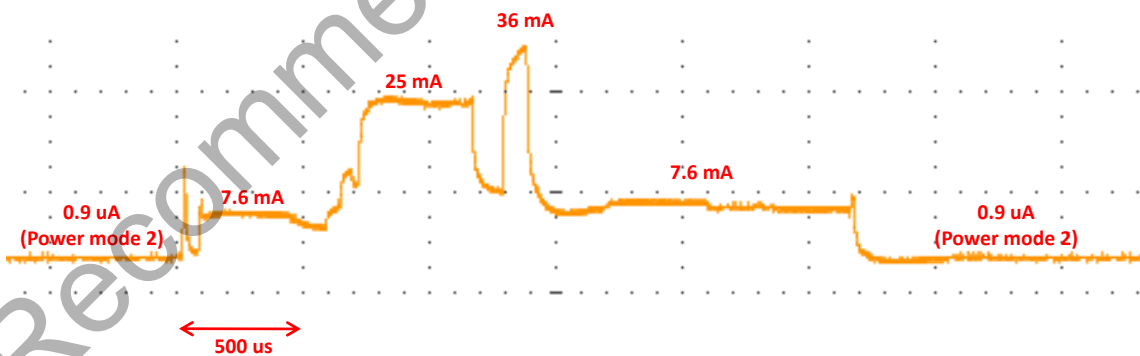

Figure 3: Typical current consumption profile during data connection in slave mode

## 2.8 RF Characteristics

### 2.8.1 TX Power vs HW Configuration

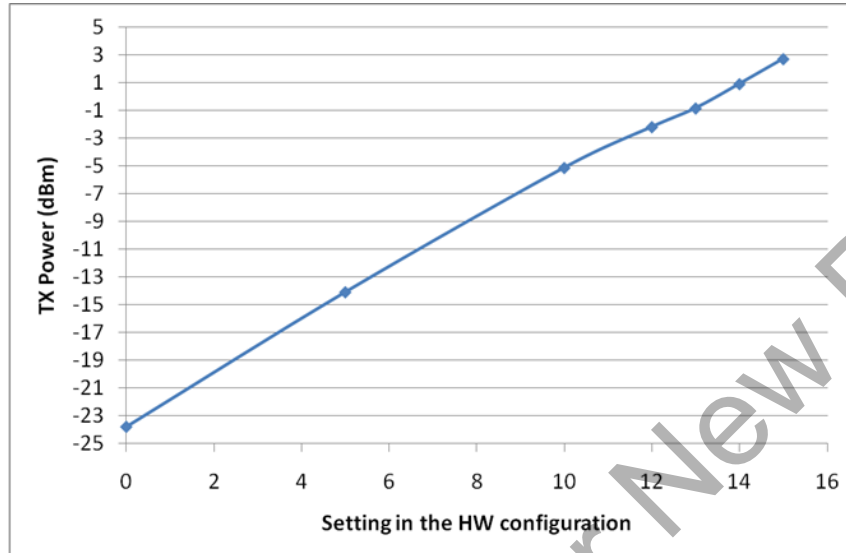

Figure 4: TXP vs HW Configuration

### 2.8.2 Antenna characteristics

The antenna radiation pattern is depends on the mother board layout. Following characteristics are measured from a test board based on the layout guide given in chapter 5.3.

- Efficiency 33% (-4.8 dB)
- Peak gain 0 dBi

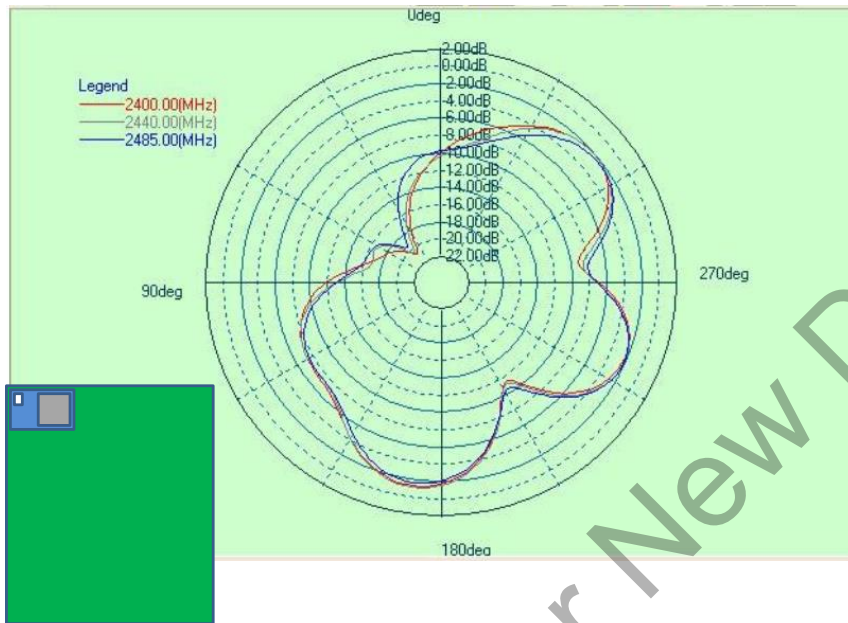

Figure 5: Radiation pattern of BLE112, top view

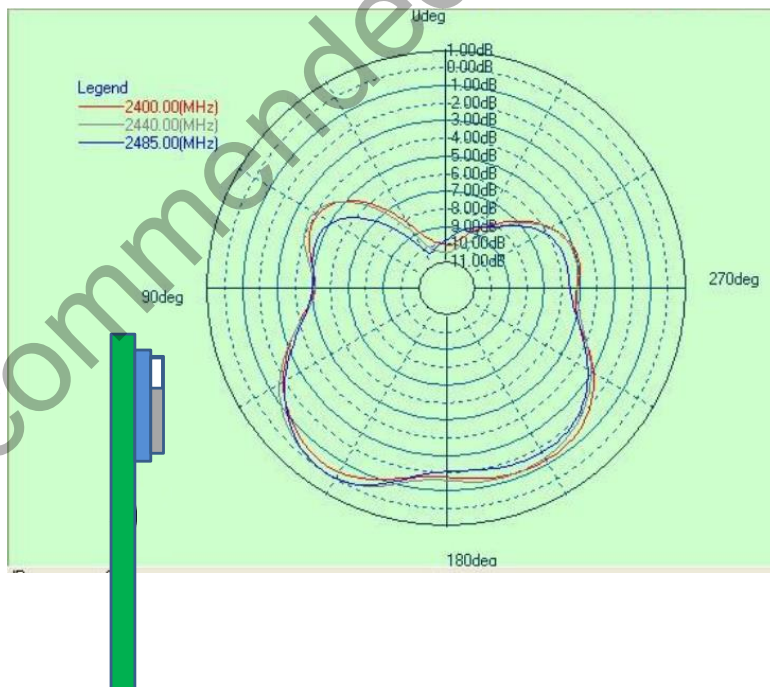

Figure 6: Radiation pattern of BLE112, front view

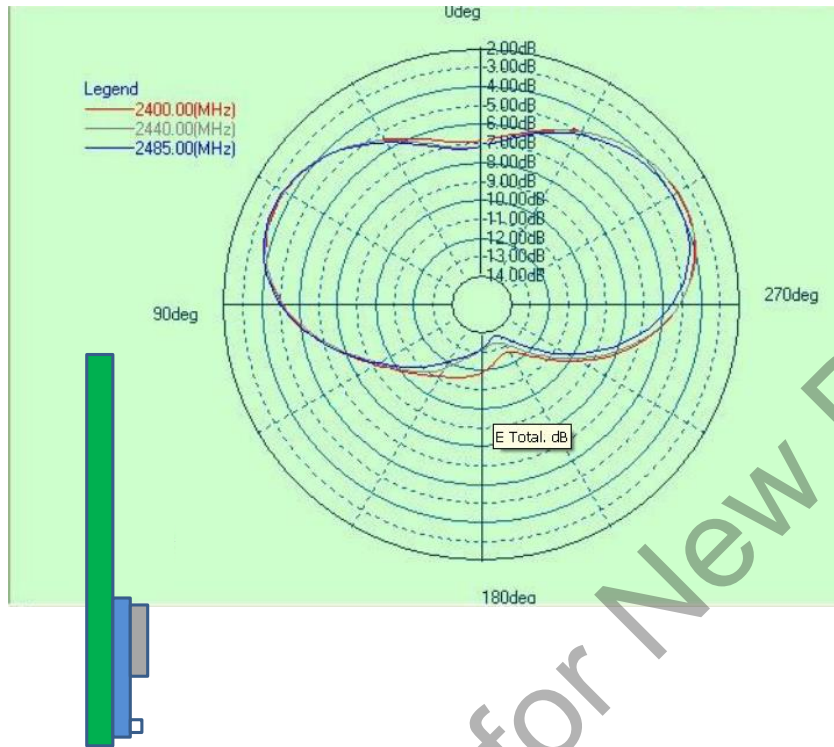

Figure 7: Radiation pattern of BLE112, side view

Not Recommended for New Designs

### 3 Physical Dimensions

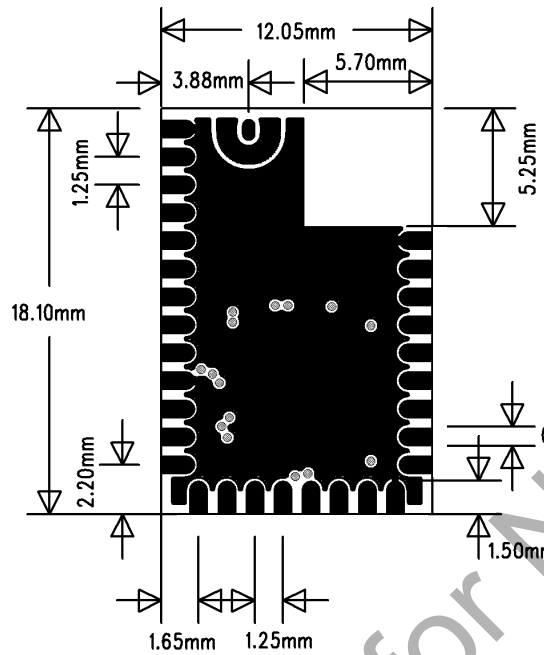

Figure 8: Physical dimensions and pinout (top view)

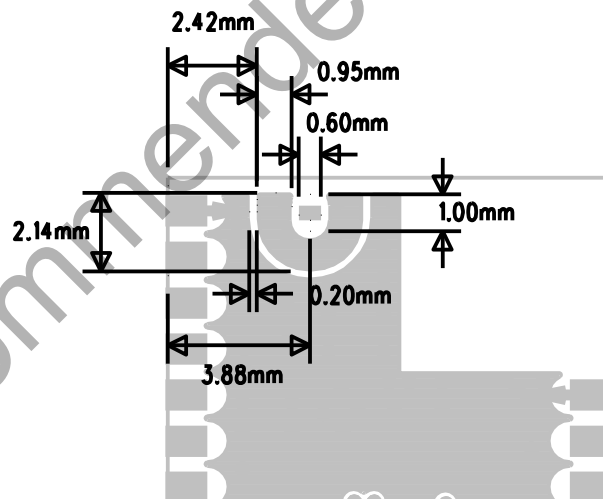

Figure 9: Dimensions for the RF pin



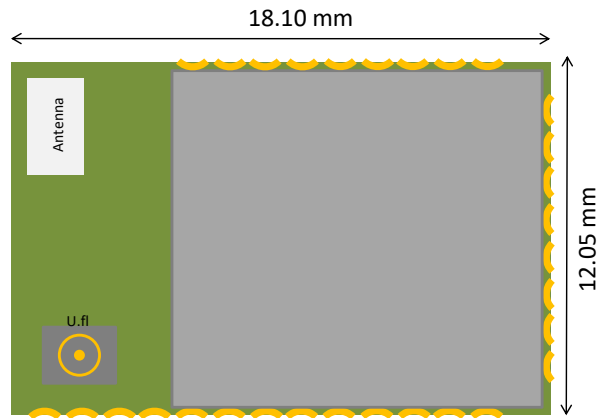

Figure 10: Physical dimensions (top view)

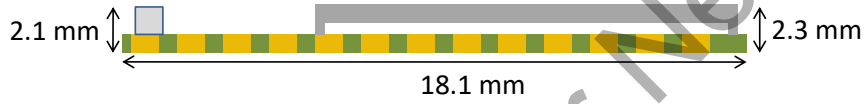

Figure 11: Physical dimensions (side view)

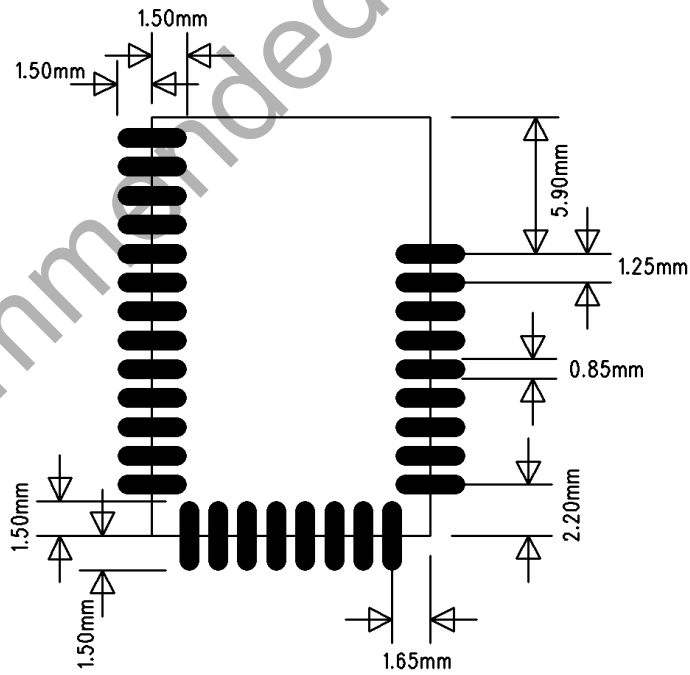

Figure 12: Recommended land pattern for BLE112-A and BLE112-E

## 4 Power-On Reset and Brownout Detector

BLE112 includes a power-on reset (POR), providing correct initialization during device power on. It also includes a brownout detector (BOD) operating on the regulated 1.8-V digital power supply only. The BOD protects the memory contents during supply voltage variations which cause the regulated 1.8-V power to drop below the minimum level required by digital logic, flash memory, and SRAM. When power is initially applied, the POR and BOD hold the device in the reset state until the supply voltage rises above the power-on-reset and brownout voltages.

Not Recommended for New Designs

## 5 Design Guidelines

### 5.1 General Design Guidelines

BLE112 can be used directly with a coin cell battery. Due to relatively high internal resistance of a coin cell battery it is recommended to place a 100uF capacitor in parallel with the battery. The internal resistance of a coin cell battery is initially in the range of 10 ohms but the resistance increases rapidly as the capacity is used. Basically the higher the value of the capacitor the higher is the effective capacity of the battery and thus the longer the life time for the application. The minimum value for the capacitor depends on the end application and the maximum transmit power used. The leakage current of a 100uF capacitor is in the range of 0.5 uA to 3 uA and generally ceramic capacitors have lower leakage current than tantalum or aluminum electrolytic capacitors.

Optionally TI's TPS62730 can be used to reduce the current consumption during TX/RX and data processing stages. TPS62730 is an ultra low power DC/DC converter with by-pass mode and will reduce the current consumption during transmission nominally by ~20% when using 3V coin cell battery.

A ferrite bead is recommended to be used to filter any excessive noise in the power supply lines to guarantee the radio performance.

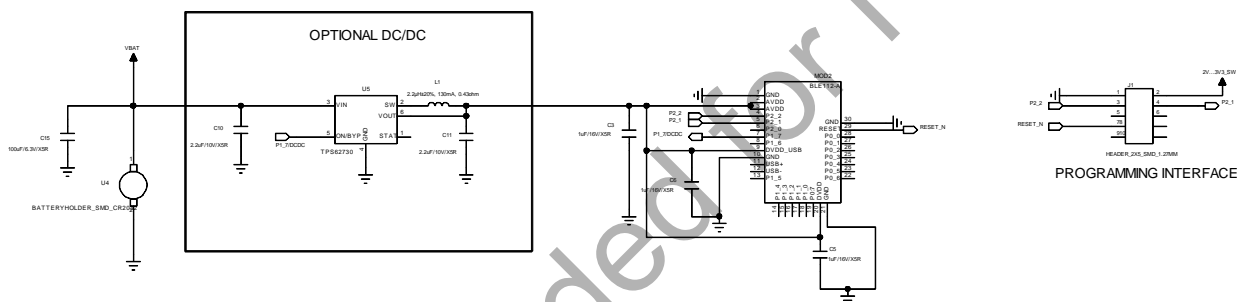

Figure 13: Example schematic for BLE112 with a coin cell battery

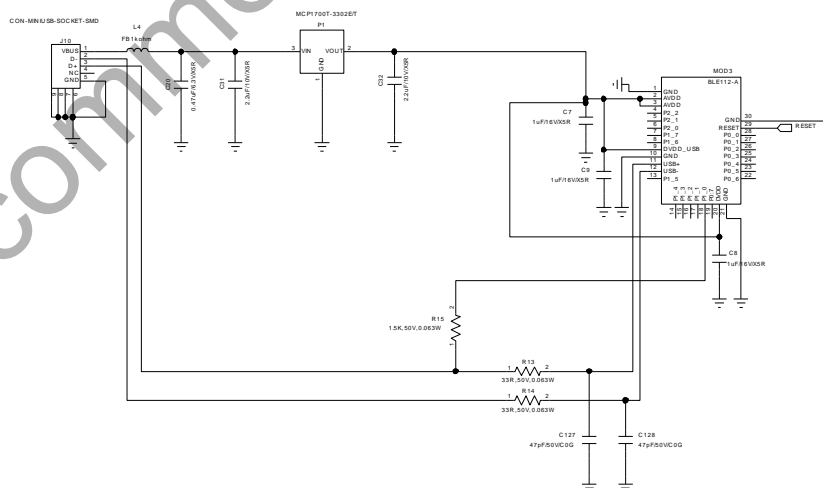

Figure 14: Example schematic for BLE112 with USB

## 5.2 Layout Guide Lines

Use good layout practices to avoid excessive noise coupling to supply voltage traces or sensitive analog signal traces. If using overlapping ground planes use stitching vias separated by max 3 mm to avoid emission from the edges of the PCB. Connect all the GND pins directly to a solid GND plane and make sure that there is a low impedance path for the return current following the signal and supply traces all the way from start to the end.

A good practice is to dedicate one of the inner layers to a solid GND plane and one of the inner layers to supply voltage planes and traces and route all the signals on top and bottom layers of the PCB. This arrangement will make sure that any return current follows the forward current as close as possible and any loops are minimized.



**Figure 15:** Typical 4-layer PCB construction

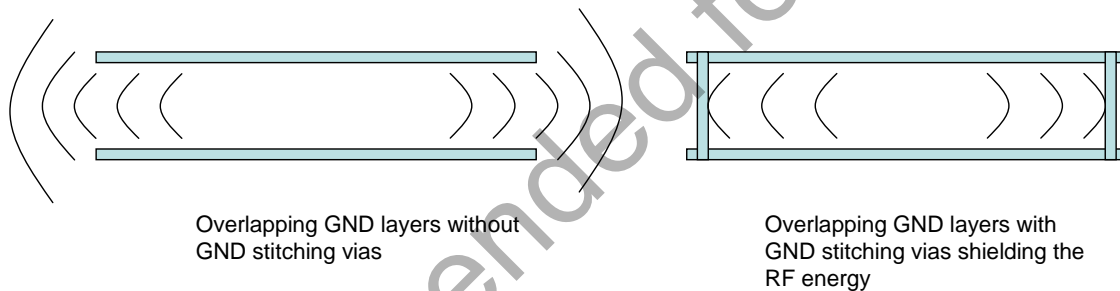

**Figure 16:** Use of stitching vias to avoid emissions from the edges of the PCB

## 5.3 BLE112-A Layout Guide

For optimal performance of the antenna place the module at the corner of the PCB as shown in the Figure 17. Do not place any metal (traces, components, battery etc.) within the clearance area of the antenna. Connect all the GND pins directly to a solid GND plane. Place the GND vias as close to the GND pins as possible. Use good layout practices to avoid any excessive noise coupling to signal lines or supply voltage lines. Avoid placing plastic or any other dielectric material closer than 5 mm from the antenna. Any dielectric closer than 5 mm from the antenna will detune the antenna to lower frequencies.

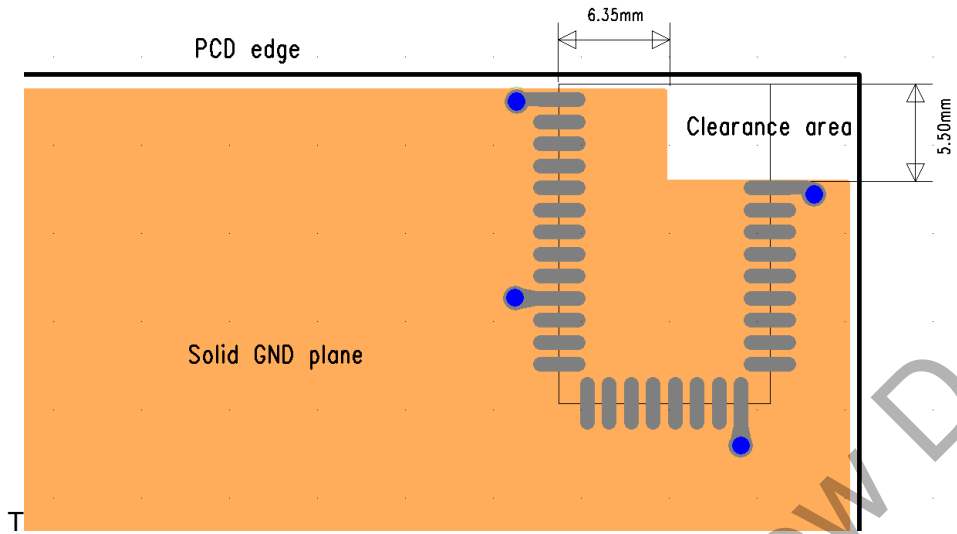

Figure 17: Recommended layout for BLE112-A

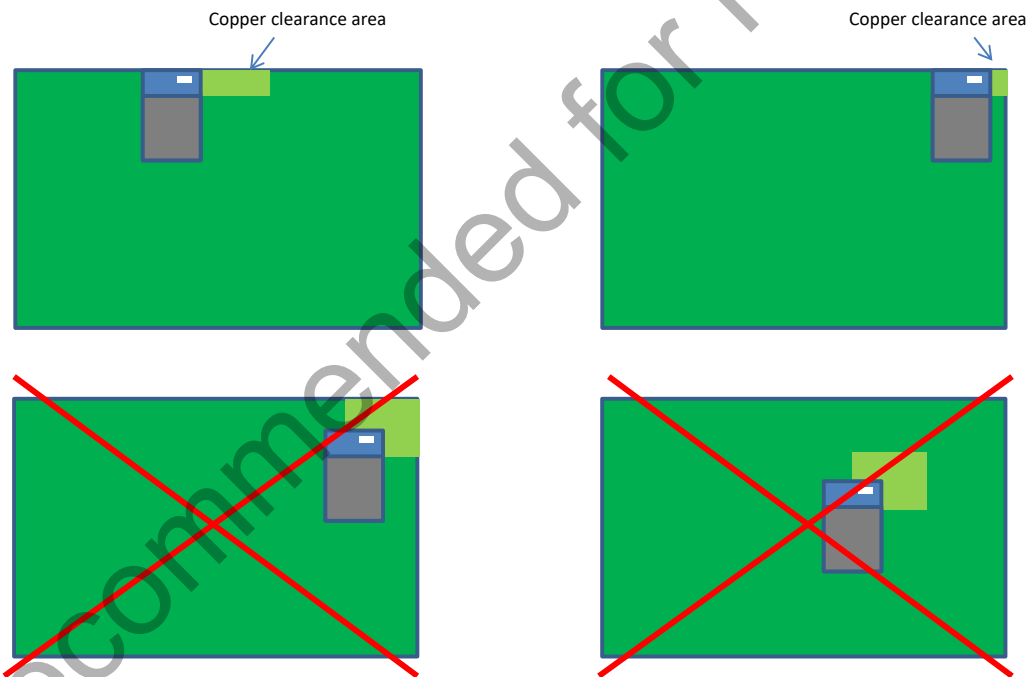
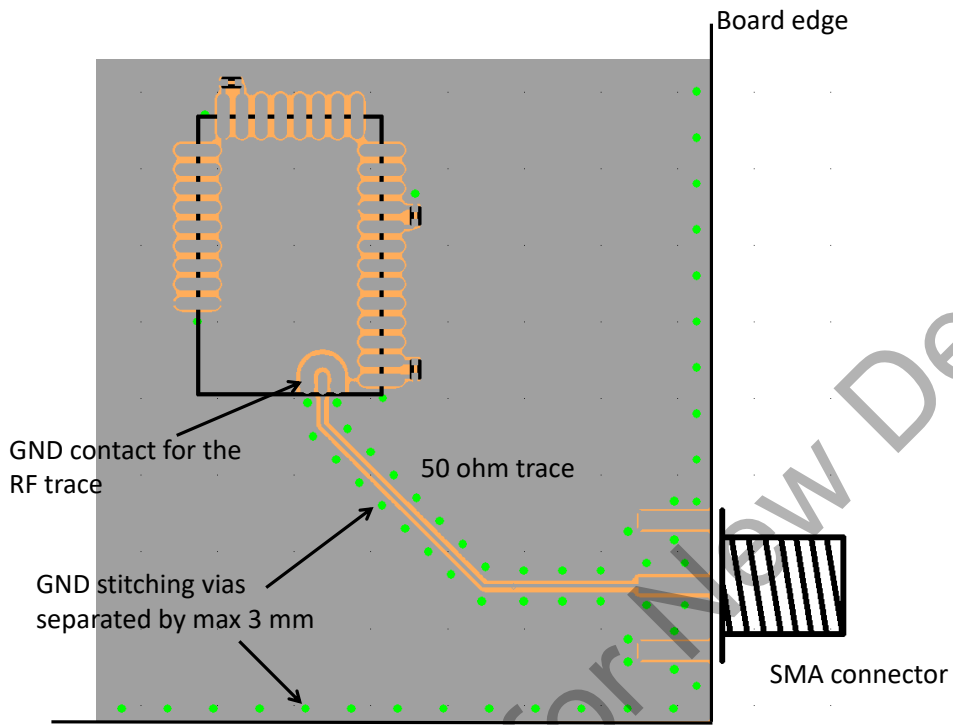

Figure 18: Layout examples for BLE112

#### 5.4 BLE112-N Layout Guide

Use 50 ohm transmission line to trace the signal from RF pin to an external RF connector. Figure 19 shows a layout example for BLE112-N with an external SMA connector.



**Figure 19: Example layout for BLE112-N**

A transmission line impedance calculator, such as TX-Line made by AWR, can be used to approximate the dimensions for the 50 ohm transmission line. Figure 20 shows an example for two different 50 ohm transmission lines.

Not Recommended for New Designs

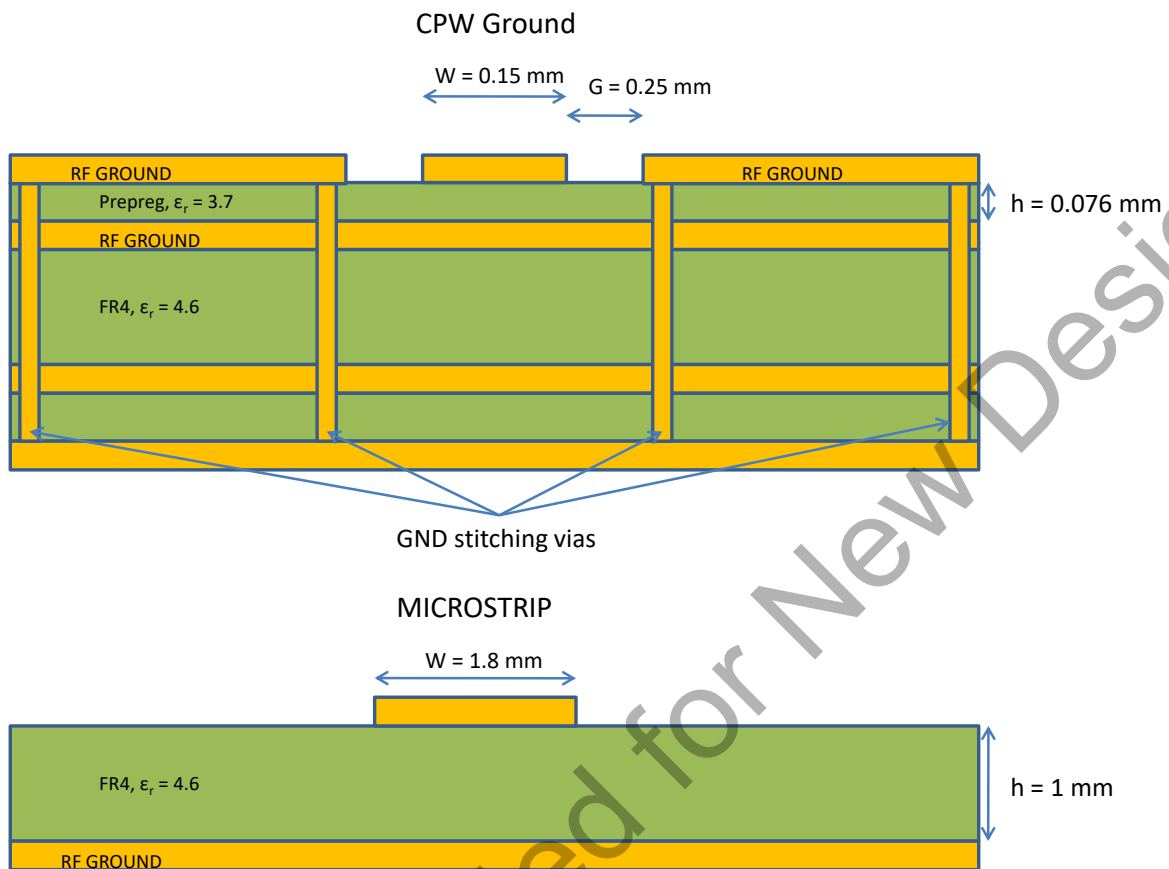

Figure 20: Example cross section of two different 50 ohm transmission line

## 5.5 Design Check List

- Antenna is placed at the edge of a PCB, preferably to a corner
- Antenna has sufficient clearance area around it and it is not covered by metal
- All the GND pins are connected to a solid GND plane
- All the IOs are in a known state and there are no leakage paths from the IOs
  - UART and SPI inputs must have external pull-up or pull-down
  - P1\_0 and P1\_1 must have either external pull-up or pull-down or configured as output
- TX power is set not higher than required for each application
- By-pass capacitor (47 uF... 100uF) is placed parallel with a coin cell battery to compensate the high series resistance of a coin cell
- Current test point is placed to measure the sleep current

## 6 Soldering Recommendations

BLE112 is compatible with industrial standard reflow profile for Pb-free solders. The reflow profile used is dependent on the thermal mass of the entire populated PCB, heat transfer efficiency of the oven and particular type of solder paste used. Consult the datasheet of particular solder paste for profile configurations.

Silicon Laboratories will give following recommendations for soldering the module to ensure reliable solder joint and operation of the module after soldering. Since the profile used is process and layout dependent, the optimum profile should be studied case by case. Thus following recommendation should be taken as a starting point guide.

- Refer to technical documentations of particular solder paste for profile configurations
- Avoid using more than one flow.
- Reliability of the solder joint and self-alignment of the component are dependent on the solder volume. Minimum of 100 $\mu$ m stencil thickness is recommended.
- Aperture size of the stencil should be 1:1 with the pad size.
- A low residue, "no clean" solder paste should be used due to low mounted height of the component.



## 7 Block diagram

BLE112 is based on TI's CC2540 chip. Embedded 32 MHz and 32.768 kHz crystals are used for clock generation. Matched balun and low pass filter provide optimal radio performance with extremely low spurious emissions. Small ceramic chip antenna gives good radiation efficiency even when the module is used in layouts with very limited space.

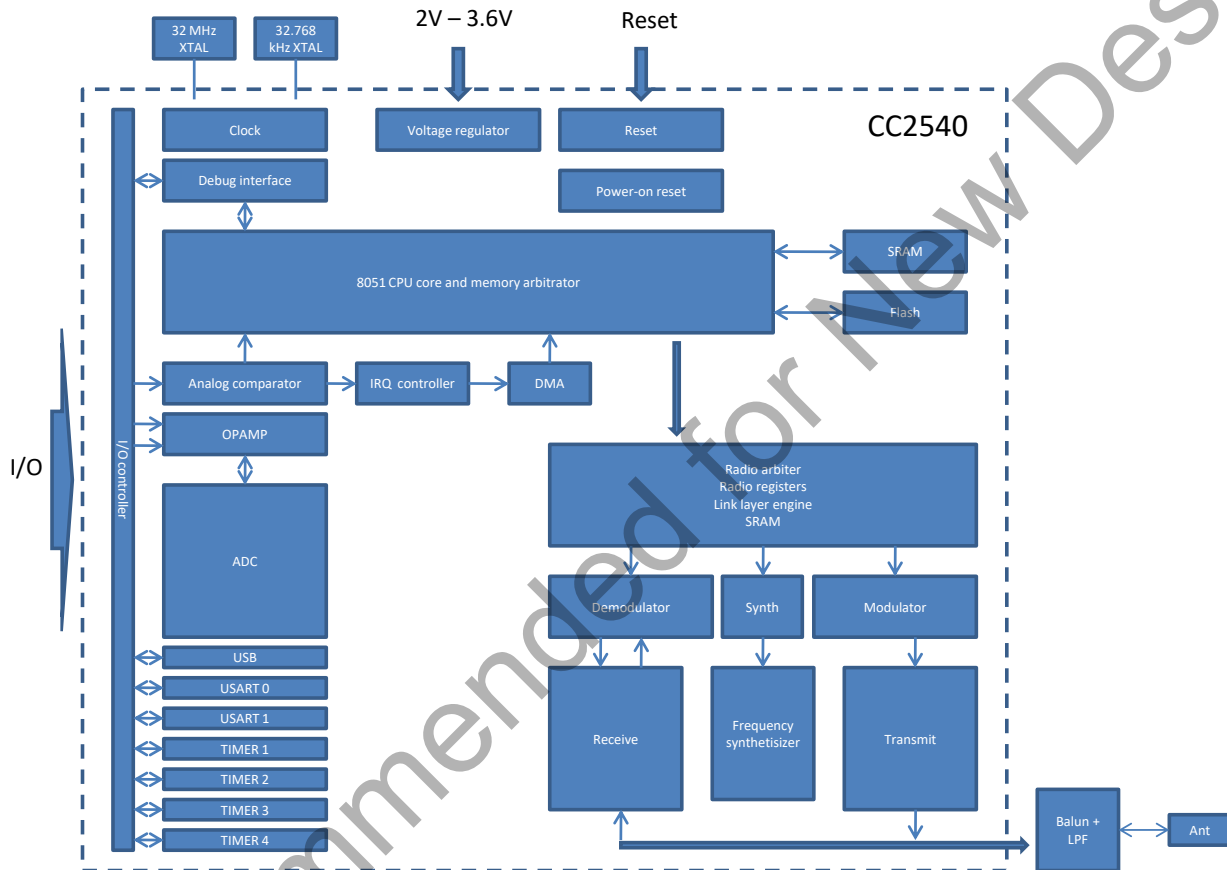

Figure 21: Simplified block diagram of BLE112

### CPU and Memory

The 8051 CPU core is a single-cycle 8051-compatible core. It has three different memory access buses (SFR, DATA, and CODE/XDATA), a debug interface, and an 18-input extended interrupt unit.

The memory arbiter is at the heart of the system, as it connects the CPU and DMA controller with the physical memories and all peripherals through the SFR bus. The memory arbiter has four memory-access points, access of which can map to one of three physical memories: an SRAM, flash memory, and XREG/SFR registers. It is responsible for performing arbitration and sequencing between simultaneous memory accesses to the same physical memory.

The SFR bus is a common bus that connects all hardware peripherals to the memory arbiter. The SFR bus also provides access to the radio registers in the radio register bank, even though these are indeed mapped into XDATA memory space.

The 8-KB SRAM maps to the DATA memory space and to parts of the XDATA memory spaces. The SRAM is an ultralow-power SRAM that retains its contents even when the digital part is powered off (power modes 2 and 3).

The 128/256 KB flash block provides in-circuit programmable non-volatile program memory for the device, and maps into the CODE and XDATA memory spaces.

### **Peripherals**

Writing to the flash block is performed through a flash controller that allows page-wise erasure and 4-bytewise programming.

A versatile five-channel DMA controller is available in the system, accesses memory using the XDATA memory space, and thus has access to all physical memories. Each channel (trigger, priority, transfer mode, addressing mode, source and destination pointers, and transfer count) is configured with DMA descriptors that can be located anywhere in memory. Many of the hardware peripherals (AES core, flash controller, USARTs, timers, ADC interface, etc.) can be used with the DMA controller for efficient operation by performing data transfers between a single SFR or XREG address and flash/SRAM.

Each CC2540 contains a unique 48-bit IEEE address that can be used as the public device address for a *Bluetooth* device. Designers are free to use this address, or provide their own, as described in the *Bluetooth* specification.

The interrupt controller services a total of 18 interrupt sources, divided into six interrupt groups, each of which is associated with one of four interrupt priorities. I/O and sleep timer interrupt requests are serviced even if the device is in a sleep mode (power modes 1 and 2) by bringing the CC2540 back to the active mode.

The debug interface implements a proprietary two-wire serial interface that is used for in-circuit debugging. Through this debug interface, it is possible to erase or program the entire flash memory, control which oscillators are enabled, stop and start execution of the user program, execute instructions on the 8051 core, set code breakpoints, and single-step through instructions in the code. Using these techniques, it is possible to perform in-circuit debugging and external flash programming elegantly.

The I/O controller is responsible for all general-purpose I/O pins. The CPU can configure whether peripheral modules control certain pins or whether they are under software control, and if so, whether each pin is configured as an input or output and if a pullup or pulldown resistor in the pad is connected. Each peripheral that connects to the I/O pins can choose between two different I/O pin locations to ensure flexibility in various applications.

The sleep timer is an ultra low power timer that uses an external 32.768-kHz crystal oscillator. The sleep timer runs continuously in all operating modes except power mode 3. Typical applications of this timer are as a real-time counter or as a wake-up timer to exit power modes 1 or 2.

A built-in watchdog timer allows the CC2540 to reset itself if the firmware hangs. When enabled by software, the watchdog timer must be cleared periodically; otherwise, it resets the device when it times out.

Timer 1 is a 16-bit timer with timer/counter/PWM functionality. It has a programmable prescaler, a 16-bit period value, and five individually programmable counter/capture channels, each with a 16-bit compare value. Each of the counter/capture channels can be used as a PWM output or to capture the timing of edges on input signals. It can also be configured in IR generation mode, where it counts timer 3 periods and the output is ANDed with the output of timer 3 to generate modulated consumer IR signals with minimal CPU interaction.

Timer 2 is a 40-bit timer used by the *Bluetooth* Low Energy stack. It has a 16-bit counter with a configurable timer period and a 24-bit overflow counter that can be used to keep track of the number of periods that have transpired. A 40-bit capture register is also used to record the exact time at which a start-of-frame delimiter is received/transmitted or the exact time at which transmission ends. There are two 16-bit timer-compare registers and two 24-bit overflow-compare registers that can be used to give exact timing for start of RX or TX to the radio or general interrupts.

Timer 3 and timer 4 are 8-bit timers with timer/counter/PWM functionality. They have a programmable prescaler, an 8-bit period value, and one programmable counter channel with an 8-bit compare value. Each of the counter channels can be used as PWM output.

USART 0 and USART 1 are each configurable as either an SPI master/slave or a UART. They provide double buffering on both RX and TX and hardware flow control and are thus well suited to high-throughput full-duplex applications. Each USART has its own high-precision baud-rate generator, thus leaving the ordinary timers free for other uses. When configured as SPI slaves, the USARTs sample the input signal using SCK directly instead of using some oversampling scheme, and are thus well-suited for high data rates.

The AES encryption/decryption core (with CBC-MAC) allows the user to encrypt and decrypt data using the AES algorithm with 128-bit keys.

The ADC supports 7 to 12 bits of resolution with a corresponding range of bandwidths from 30-kHz to 4-kHz, respectively. DC and audio conversions with up to eight input channels (I/O controller pins) are possible. The inputs can be selected as single-ended or differential. The reference voltage can be internal, AVDD, or a single-ended or differential external signal. The ADC also has a temperature-sensor input channel. The ADC can automate the process of periodic sampling or conversion over a sequence of channels.

The ultralow-power analog comparator enables applications to wake up from PM2 or PM3 based on an analog signal. Both inputs are brought out to pins; the reference voltage must be provided externally. The comparator output is connected to the I/O controller interrupt detector and can be treated by the MCU as a regular I/O pin interrupt.

#### **RF front end**

RF front end includes combined matched balun and low pass filter, and ceramic chip antenna with matching network. Optimal matching combined with effective low pass filter provides extremely low in-band spurious emissions and harmonics. Optionally as a module assembly variant RF can be traced either to an embedded u.fl connector or to the RF pin of the module.

## 8 Certifications

BLE112 is compliant to the following specifications.

### 8.1 Bluetooth

BLE112 Bluetooth Low Energy module is *Bluetooth* qualified and listed as a controller subsystem and it is Bluetooth compliant to the following profiles of the core spec version v.4.0:

- RF PHY
- HCI
- LL

The maximum antenna gain specified for BLE112 is 2.3 dBi. Bluetooth qualification is valid for any antenna with gain less than 2.3 dBi.

### 8.2 FCC and IC

This device complies with Part 15 of the FCC Rules. Operation is subject to the following two conditions:

- (1) this device may not cause harmful interference, and
- (2) this device must accept any interference received, including interference that may cause undesired operation.

#### **FCC RF Radiation Exposure Statement:**

This equipment complies with FCC radiation exposure limits set forth for an uncontrolled environment. End users must follow the specific operating instructions for satisfying RF exposure compliance. This transmitter must not be co-located or operating in conjunction with any other antenna or transmitter.

#### **IC Statements:**

This device complies with Industry Canada licence-exempt RSS standard(s). Operation is subject to the following two conditions: (1) this device may not cause interference, and (2) this device must accept any interference, including interference that may cause undesired operation of the device.

Under Industry Canada regulations, this radio transmitter may only operate using an antenna of a type and maximum (or lesser) gain approved for the transmitter by Industry Canada. To reduce potential radio interference to other users, the antenna type and its gain should be so chosen that the equivalent isotropically radiated power (e.i.r.p.) is not more than that necessary for successful communication.

#### **If detachable antennas are used:**

This radio transmitter (identify the device by certification number, or model number if Category II) has been approved by Industry Canada to operate with the antenna types listed below with the maximum permissible

gain and required antenna impedance for each antenna type indicated. Antenna types not included in this list, having a gain greater than the maximum gain indicated for that type, are strictly prohibited for use with this device. See Table 8 for the approved antennas for BLE112.

### **OEM Responsibilities to comply with FCC and Industry Canada Regulations**

The BLE112 module has been certified for integration into products only by OEM integrators under the following condition:

- The transmitter module must not be co-located or operating in conjunction with any other antenna or transmitter.

As long as the condition above is met, further transmitter testing will not be required. However, the OEM integrator is still responsible for testing their end-product for any additional compliance requirements required with this module installed (for example, digital device emissions, PC peripheral requirements, etc.).

**IMPORTANT NOTE:** In the event that these conditions can not be met (for certain configurations or co-location with another transmitter), then the FCC and Industry Canada authorizations are no longer considered valid and the FCC ID and IC Certification Number can not be used on the final product. In these circumstances, the OEM integrator will be responsible for re-evaluating the end product (including the transmitter) and obtaining a separate FCC and Industry Canada authorization.

### **End Product Labeling**

The BLE112 module is labeled with its own FCC ID and IC Certification Number. If the FCC ID and IC Certification Number are not visible when the module is installed inside another device, then the outside of the device into which the module is installed must also display a label referring to the enclosed module. In that case, the final end product must be labeled in a visible area with the following:

**“Contains Transmitter Module FCC ID: QOQBLE112”**

**“Contains Transmitter Module IC: 5123A-BGTBLE112”**

or

**“Contains FCC ID: QOQBLE112**

**“Contains IC: 5123A-BGTBLE112”**

The OEM of the BLE112 module must only use the approved antenna(s) listed in Table 8, which have been certified with this module.

The OEM integrator has to be aware not to provide information to the end user regarding how to install or remove this RF module or change RF related parameters in the user manual of the end product.

## **8.2.1 FCC et IC**

### **Déclaration d’IC :**

Ce dispositif est conforme aux normes RSS exemptes de licence d’Industrie Canada. Son fonctionnement est assujéti aux deux conditions suivantes : (1) ce dispositif ne doit pas provoquer de perturbation et (2) ce

dispositif doit accepter toute perturbation, y compris les perturbations qui peuvent entraîner un fonctionnement non désiré du dispositif.

Selon les réglementations d'Industrie Canada, cet émetteur radio ne doit fonctionner qu'avec une antenne d'une typologie spécifique et d'un gain maximum (ou inférieur) approuvé pour l'émetteur par Industrie Canada. Pour réduire les éventuelles perturbations radioélectriques nuisibles à d'autres utilisateurs, le type d'antenne et son gain doivent être choisis de manière à ce que la puissance isotrope rayonnée équivalente (P.I.R.E.) n'excède pas les valeurs nécessaires pour obtenir une communication convenable.

#### **Si des antennes amovibles sont utilisées :**

Cet émetteur radio (identifier le dispositif à l'aide de son numéro de certification ou de son numéro de modèle s'il appartient à la Catégorie II) a été approuvé par Industrie Canada pour fonctionner avec les types d'antenne énumérés ci-dessous, avec le gain admissible maximum et l'impédance d'antenne requise pour chaque type d'antenne indiqué. Les types d'antennes qui ne figurent pas dans cette liste ont un gain supérieur au gain maximum indiqué pour ce type ; il est donc strictement défendu de les utiliser avec ce dispositif. Consulter le tableau 8 pour découvrir les antennes approuvées pour BLE112.

#### **Responsabilités des OEM quant à la conformité avec les réglementations de FCC et d'Industrie Canada**

Le module BLE112 a été certifié pour être intégré à des produits fabriqués uniquement par les intégrateurs OEM dans les conditions suivantes : Le module de l'émetteur ne doit pas être situé près d'une autre antenne ou d'un autre émetteur ni ou fonctionner conjointement avec ceux-ci.

Dans la mesure où cette condition est observée, il ne sera pas nécessaire de soumettre l'émetteur à des essais supplémentaires. Cependant, l'intégrateur OEM est chargé de tester son produit final pour s'assurer qu'il respecte toutes les autres exigences de conformité requises avec ce module installé (par exemple : émissions du dispositif numérique, exigences périphériques de l'ordinateur, etc.).

**REMARQUE IMPORTANTE :** En cas d'inobservance de ces conditions (en ce qui concerne certaines configurations ou l'emplacement du dispositif à proximité d'un autre émetteur), les autorisations de FCC et d'Industrie Canada ne seront plus considérées valables et l'identification de FCC et le numéro de certification d'IC ne pourront pas être utilisés sur le produit final. Dans ces cas, l'intégrateur OEM sera chargé d'évaluer à nouveau le produit final (y compris l'émetteur) et d'obtenir une autorisation indépendante de FCC et d'Industrie Canada.

#### **Étiquetage du produit final**

Le module BLE112 est étiqueté avec sa propre identification FCC et son propre numéro de certification IC. Si l'identification FCC et le numéro de certification IC ne sont pas visibles lorsque le module est installé à l'intérieur d'un autre dispositif, la partie externe du dispositif dans lequel le module est installé devra également présenter une étiquette faisant référence au module inclus. Dans ce cas, le produit final devra être étiqueté sur une zone visible avec les informations suivantes :

« Contient module émetteur identification FCC : QOQBLE112 »

« Contient module émetteur IC : 5123A-BGTBLE112 »

ou

« Contient identification FCC : QOQBLE112 »

« Contient IC : 5123A-BGTBLE112 »

L'OEM du module BLE112 ne doit utiliser que la ou les antennes approuvées énumérées dans le tableau 8, qui ont été certifiées avec ce module.

Dans le guide d'utilisation du produit final, l'intégrateur OEM doit s'abstenir de fournir des informations à l'utilisateur final portant sur les procédures à suivre pour installer ou retirer ce module RF ou pour changer les paramètres RF.

### 8.3 CE

The BLE112 is tested against the relevant harmonized standards and is compliant with the essential requirements and other relevant requirements of the Radio Equipment Directive (RED)(2014/53/EU).

Please notice that every end-product integrating the BLE112 module will need to perform the radio EMC tests on the end-product, according to EN 301 489-17. It is ultimately the responsibility of the manufacturer to ensure the compliance of the end-product as a whole. The specific product assembly may have an impact to RF radiated characteristics, and manufacturers should carefully consider RF radiated testing with the end-product assembly.

The module is entitled to carry the CE mark, and a formal Declaration of Conformity (DoC) is available at the product web page which is reachable starting from [www.silabs.com](http://www.silabs.com).

### 8.4 MIC Japan

BLE112 is certified as a module with type certification number 209-J00046. As a certified module BLE112 can be integrated to an end product without a need for additional MIC Japan certification of the end product.

### 8.5 KCC (Korea)

BLE112 is KCC certified with following certification numbers

BLE112-A: KCC-CRM-BGT-BLE112-A

BLE112-E: KCC-CRM-BGT-BLE112-E

BLE112-N: KCC-CRM-BGT-BLE112-N

### 8.6 Anatel (Brazil)

BLE112 is certified in Brazil with Anatel certification number: 01236-16-03402

The user manual of the equipment that integrates this module must contain the following sentences:

"This equipment integrates a Bluetooth radio wireless module having Anatel homologation code of 01236-16-03402."

"This equipment is not entitled to protection against harmful interference and may not cause interference to other duly authorized systems."

O manual do usuário do equipamento que integra este módulo deve conter as seguintes frases:

"Este produto contém a placa MODEL código de homologação Anatel 01236-16-03402."

"Este equipamento não tem direito à proteção contra interferência prejudicial e não pode causar interferência em sistemas devidamente autorizados."

## 8.7 NCC (Taiwan)

The BLE112-A is certified in Taiwan with NCC certification number CCAM17LP0520T0.

BLE112-A通過了臺灣NCC認證, 認證號為CCAM17LP0520T0.

The platform manufacturer is required to mark the platform with the following sentence:

- "This product contains an RF module with ID number CCAM17LP0520T0."

平臺製造商必須在平臺上指定:

- “本產品包含一個ID號為CCAM17LP0520T0 的RF模組”

According to NCC Low Power Radio Wave Radiation Equipment Management Regulations:	
Article 12	A low-power RF equipment that has passed the type approval shall not change the frequency, increase the power or change the characteristics and functions of the original design without permission.
Article 14	<p>The use of low-power RF equipment shall not affect flight safety and interfere with legal communications; if interference is found, it shall be immediately deactivated and improved until no interference is found.</p> <p>Legal communication in the preceding paragraph refers to radio communications operating in accordance with the provisions of the Telecommunications Act.</p> <p>Low-power RF equipment must withstand interference from legitimate communications or radiological, radiated electrical equipment for industrial, scientific, and medical applications.</p>



根據 NCC 低功率電波輻射性電機管理辦法 規定:	
第十二條	經型式認證合格之低功率射頻電機，非經許可，公司、商號或使用者均不得擅自變更頻率、加大功率或變更原設計之特性及功能。
第十四條	低功率射頻電機之使用不得影響飛航安全及干擾合法通信；經發現有干擾現象時，應立即停用，並改善至無干擾時方得繼續使用。前項合法通信，指依電信法規定作業之無線電通信。低功率射頻電機須忍受合法通信或工業、科學及醫療用電波輻射性電機設備之干擾。

## 8.8 Qualified Antenna Types for BLE112-E and BLE112-N

This device has been designed to operate with a standard 2.14 dBi dipole antenna. Any antenna of the same type and the same or less gain can be used without additional application to FCC. Table 8 lists approved antennas for BLE112. Any approved antenna listed in table 8 can be used directly with BLE112 without any additional approval. Any antenna not listed in table 8 can be used with BLE112 as long as detailed information from that particular antenna is provided to Silicon Labs for approval. Specification of each antenna used with BLE112 will be filed by Silicon Labs. Please, contact [www.silabs.com/support](http://www.silabs.com/support) for more information.

Item	Manufacturer	Manufacturers part number	Measured Gain (dBi)	Specified Gain (dBi)	Measure Total Efficiency (%)
1	Pulse	W1030	1	2 dBi	70 - 80
2	Linx Technologies Inc	ANT-2.4-CW-CT-SMA	1.3	2 dBi	77
3	EAD	EA-79A	0.4	2 dBi	60
4	Antenova	B4844/B6090	1.4	2 dBi	76 - 82
5	Litecon	CAR-ATR-187-001	0.8	2 dBi	60 - 70

**Table 8:** Approved Antennas for BLE112-E and BLE112-N

## 9 Tape and reel information

### BLE112-A-V1 Package Spec

#### 1. Package direction and Tape spec

Package direction:

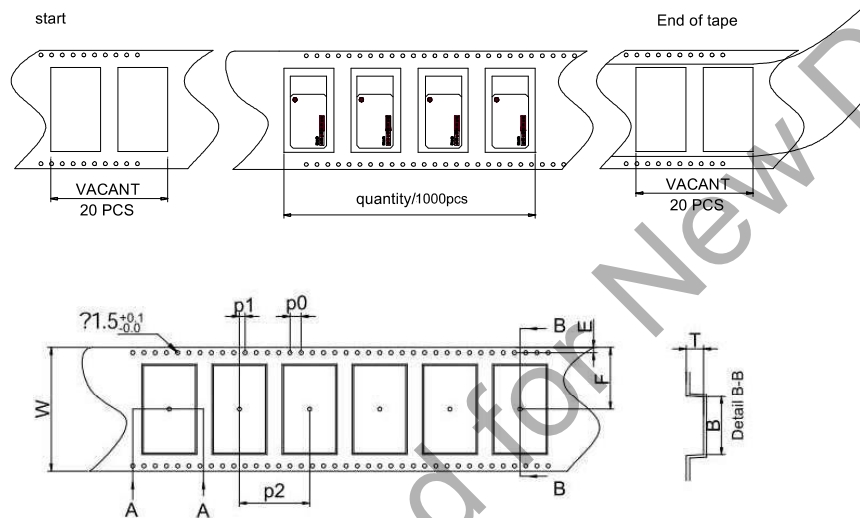

P/N	A	B	W	F	E	P0	P1	P2	T
3500275600									
size(mm)	12.45	18.5	44	20.2	1.75	4.0	2.0	20.0	2.7
Tolerance	+0.15 -0	+0.15 -0	+/-0.3	+/-0.15	+0.1	+/-0.1	+/-0.15	+/-0.1	+0.15 -0

#### NOTES:

- 10 sprocket hole pitch cumulative tolerance +0.15/-0mm
- carrier camber not to exceed 1mm in 100mm
- A and B measured on a plane 0.3mm above the bottom of the pocket
- T measure form 0 plane on the inside bottom of the pocket to the lop surface of the carrier.
- All dimensions meet EIA-481-C requirments.
- material: black Anti-static Polystyrene
- Resistivity  $10^{-11}$ /square.

		DESCRIPTION :	
		Package Spec	
		MODELNO .	
		BLE112-A-V1	
Date	Drawn	DOCUMENTNO . :	REV.
		MPG-6384010-0A	01

# 10 Reel appearance and dimensions

Reel Appearance and Dimensions

Location	A	B	C	D	W1	W2
Dimensions	330	100	13.0	2.2	44.5	49.1
Tolerance	±0.5	±1	±0.2	±0.5	±0.1	±0.2

NOTES:  
 1. MATERIAL:HIPS,ANT-STATIC 10<sup>5</sup>~10<sup>11</sup> OHM/SQ.  
 2.COLOR:BLUE

INTECH PN: MPG-6331010-0A

		<b>Drawn:</b> 2007.10.25	<b>Design:</b> 2007.10.25
		 THIRD ANGLE PROJECTION	<b>DESCRIPTION:</b> Plastic Reel
<b>DIMENSIONAL TOLERANCES</b> ( ) ( ) ( ) ( ) (<30 :±0.25    DECIMALS    UP-100 :±0.2    250-300:±0.4    UP-600 :±1.5 >30-100 :±0.35    X :±0.3    100-150:±0.25    300-350:±0.45    600-900 :±2.4 >100-300 :±0.5    XX :±0.2    150-200:±0.3    350-400:±0.5    900-OVER:±3.1 ABOVE 300:±0.6    XXX:±0.1    200-250:±0.35		A4 SIZE	<b>PART NO.:</b>  SHEET 2 OF 2    ISSUE DATE:
<b>SCALE</b>	<b>UNIT</b> mm    USED ON	Bluegiga WT32	
		REV.  01	

DF-ME44Y-1800

# Simplicity Studio

One-click access to MCU and wireless tools, documentation, software, source code libraries & more. Available for Windows, Mac and Linux!



**IoT Portfolio**

[www.silabs.com/iot](http://www.silabs.com/iot)



**SW/HW**

[www.silabs.com/simplicity](http://www.silabs.com/simplicity)



**Quality**

[www.silabs.com/quality](http://www.silabs.com/quality)



**Support & Community**

[www.silabs.com/community](http://www.silabs.com/community)

## Disclaimer

Silicon Labs intends to provide customers with the latest, accurate, and in-depth documentation of all peripherals and modules available for system and software implementers using or intending to use the Silicon Labs products. Characterization data, available modules and peripherals, memory sizes and memory addresses refer to each specific device, and "Typical" parameters provided can and do vary in different applications. Application examples described herein are for illustrative purposes only. Silicon Labs reserves the right to make changes without further notice to the product information, specifications, and descriptions herein, and does not give warranties as to the accuracy or completeness of the included information. Without prior notification, Silicon Labs may update product firmware during the manufacturing process for security or reliability reasons. Such changes will not alter the specifications or the performance of the product. Silicon Labs shall have no liability for the consequences of use of the information supplied in this document. This document does not imply or expressly grant any license to design or fabricate any integrated circuits. The products are not designed or authorized to be used within any FDA Class III devices, applications for which FDA premarket approval is required, or Life Support Systems without the specific written consent of Silicon Labs. A "Life Support System" is any product or system intended to support or sustain life and/or health, which, if it fails, can be reasonably expected to result in significant personal injury or death. Silicon Labs products are not designed or authorized for military applications. Silicon Labs products shall under no circumstances be used in weapons of mass destruction including (but not limited to) nuclear, biological or chemical weapons, or missiles capable of delivering such weapons. Silicon Labs disclaims all express and implied warranties and shall not be responsible or liable for any injuries or damages related to use of a Silicon Labs product in such unauthorized applications.

## Trademark Information

Silicon Laboratories Inc.®, Silicon Laboratories®, Silicon Labs®, SiLabs® and the Silicon Labs logo®, Bluegiga®, Bluegiga Logo®, ClockBuilder®, CMEMS®, DSPLL®, EFM®, EFM32®, EFR®, Ember®, Energy Micro, Energy Micro logo and combinations thereof, "the world's most energy friendly microcontrollers", Ember®, EZLink®, EZRadio®, EZRadioPRO®, Gecko®, Gecko OS, Gecko OS Studio, ISOModem®, Precision32®, ProSLIC®, Simplicity Studio®, SiPHY®, Telegesis, the Telegesis Logo®, USBXpress®, Zentri, the Zentri logo and Zentri DMS, Z-Wave®, and others are trademarks or registered trademarks of Silicon Labs. ARM, CORTEX, Cortex-M3 and THUMB are trademarks or registered trademarks of ARM Holdings. Keil is a registered trademark of ARM Limited. Wi-Fi is a registered trademark of the Wi-Fi Alliance. All other products or brand names mentioned herein are trademarks of their respective holders.



Silicon Laboratories Inc.  
400 West Cesar Chavez  
Austin, TX 78701  
USA

<http://www.silabs.com>

# Mouser Electronics

Authorized Distributor

Click to View Pricing, Inventory, Delivery & Lifecycle Information:

[Silicon Laboratories:](#)

[BLE112-E-V1](#) [BLE112-A-V1](#) [BLE112-A-V1C](#) [BLE112-E-V1C](#)