

**Chip Ferrite Bead BLM41PG□□□SN1□ Reference Specification**

**1. Scope**

This reference specification applies to Chip Ferrite Bead BLM41\_SN Series.

**2. Part Numbering**

(ex.) BL M 41 PG 600 S N 1 L  
 (1) (2) (3) (4) (5) (6) (7) (8) (9)  
 (1)Product ID (4)Characteristics (7)Category  
 (2)Type (5)Typical Impedance at 100MHz (8)Numbers of Circuit  
 (3)Dimension (LxW) (6)Performance (9)Packaging (L:Taping / B:Bulk)

**3. Rating**

Customer Part Number	MURATA Part Number	Impedance (Ω) (at 100MHz, Under Standard Testing Condition)	Rated Current (mA) (*1)			DC Resistance (Ω) max.		Remark
			Typical	at 85°C	at 125°C	Initial Values	Values After Testing	
	BLM41PG600SN1L	30 min.	60	*1	*1	0.009	0.018	For DC power line
	BLM41PG600SN1B			6000	3700			
	BLM41PG750SN1L	45 min.	75	*1	*1	0.015	0.03	
	BLM41PG750SN1B			3500	2450			
	BLM41PG181SN1L	180±25%	180	*1	*1	0.02	0.04	
	BLM41PG181SN1B			3500	2100			
	BLM41PG471SN1L	470±25%	470	*1	*1	0.05	0.10	
	BLM41PG471SN1B			2000	1350			
	BLM41PG102SN1L	1000±25%	1000	*1	*1	0.09	0.18	
	BLM41PG102SN1B			1500	1000			

• Operating Temperature: -55°C to +125°C • Storage Temperature: -55°C to +125°C

(\*1) In case of Rated current is more than \*1, Rated Current is derated as right figure depending on the operating temperature.

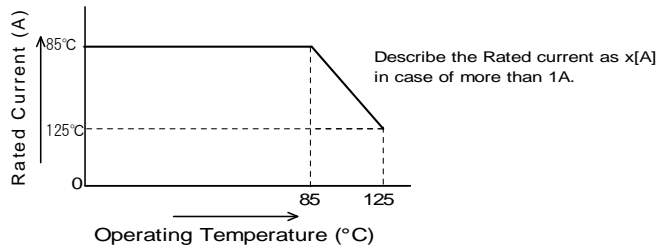

**4. Style and Dimensions**

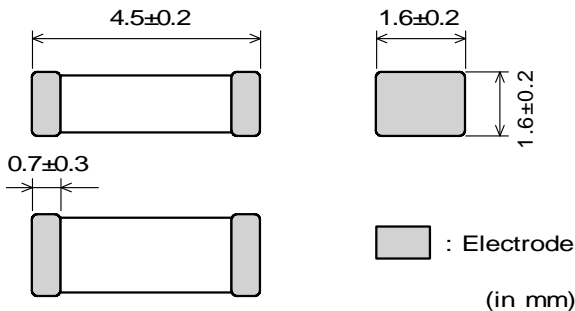

■ Equivalent Circuit

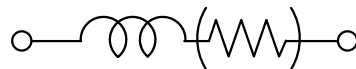

( Resistance element becomes dominant at high frequencies. )

■ Unit Mass (Typical value)  
0.050g

**5. Marking**

No marking.

**6. Standard Testing Conditions**

< Unless otherwise specified >  
 Temperature : Ordinary Temp. (15 °C to 35 °C)  
 Humidity : Ordinary Humidity (25%(RH) to 85%(RH))

< In case of doubt >  
 Temperature : 20°C±2 °C  
 Humidity : 60%(RH) to 70%(RH)  
 Atmospheric pressure : 86kPa to 106kPa

## 7. Specifications

## 7-1. Electrical Performance

No.	Item	Specification	Test Method
7-1-1	Impedance	Meet item 3.	Measuring Frequency : 100MHz±1MHz Measuring Equipment : Agilent 4291A or the equivalent Test Fixture : Agilent 16192A or the equivalent
7-1-2	DC Resistance	Meet item 3.	Measuring Equipment : Digital multi meter

## 7-2. Mechanical Performance

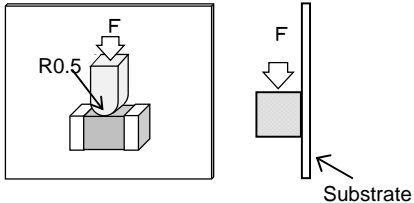
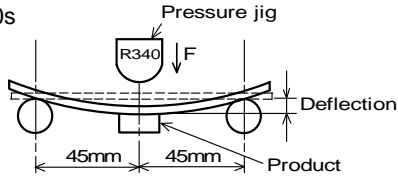
No.	Item	Specification	Test Method						
7-2-1	Appearance and Dimensions	Meet item 4.	Visual Inspection and measured with Slide Calipers.						
7-2-2	Bonding Strength	Meet Table 1.  <table border="1"> <caption>Table 1</caption> <thead> <tr> <th>Appearance</th> <th>No damage</th> </tr> </thead> <tbody> <tr> <td>Impedance Change (at 100MHz)</td> <td>Within ±30%</td> </tr> <tr> <td>DC Resistance</td> <td>Meet item 3.</td> </tr> </tbody> </table>	Appearance	No damage	Impedance Change (at 100MHz)	Within ±30%	DC Resistance	Meet item 3.	It shall be soldered on the substrate. Applying Force(F) : 9.8N Applying Time : 5s±1s Applied direction:Parallel to substrate  
Appearance	No damage								
Impedance Change (at 100MHz)	Within ±30%								
DC Resistance	Meet item 3.								
7-2-3	Bending Strength		It shall be soldered on the substrate. Substrate : Glass-epoxy 100mm×40mm×1.6mm Deflection : 1.0mm Speed of Applying Force : 0.5mm/s Keeping Time : 30s  						
7-2-4	Vibration		It shall be soldered on the substrate. Oscillation Frequency : 10Hz to 55Hz to 10Hz for 1 min Total Amplitude : 1.5mm Testing Time : A period of 2 hours in each of 3 mutually perpendicular directions. (Total 6 h)						
7-2-5	Resistance to Soldering Heat		Pre-Heating : 150°C±10°C, 60s~90s Solder : Sn-3.0Ag-0.5Cu Solder Temperature : 270°C±5°C Immersion Time : 10s±0.5s Immersion and emersion rates : 25mm/s Then measured after exposure in the room condition for 48h±4h.						
7-2-6	Drop	Products shall be no failure after tested.	It shall be dropped on concrete or steel board. Method : free fall Height : 75cm Attitude from which the product is dropped : 3 direction The number of times : 3 times for each direction (Total 9 times)						
7-2-7	Solderability	The electrodes shall be at least 95% covered with new solder coating.	Flux : Ethanol solution of rosin,25(wt)% Pre-Heating : 150°C±10°C, 60s~90s Solder : Sn-3.0Ag-0.5Cu Solder Temperature : 240°C±5°C Immersion Time : 4s±1s Immersion and emersion rates : 25mm/s						

**7-3. Environmental Performance**

It shall be soldered on the substrate.

No.	Item	Specification	Test Method
7-3-1	Temperature Cycle	Meet Table 1.	1 cycle: 1 step:-55 °C(+0 °C,-3 °C) / 30min±3min 2 step:Ordinary temp. / 10min to 15min 3 step:+125 °C(+3 °C,-0 °C) / 30min±3min 4 step: Ordinary temp. / 10min to 15min Total of 100 cycles Then measured after exposure in the room condition for 48h±4h.
7-3-2	Humidity		Temperature : 40°C±2°C Humidity : 90%(RH) to 95%(RH) Time : 1000h(+48h,-0h) Then measured after exposure in the room condition for 48h±4h.
7-3-3	Heat Life		Temperature : 85°C±3°C Applying Current : Rated Current Time : 1000h(+48h,-0h) Then measured after exposure in the room condition for 48h±4h.
7-3-4	Cold Resistance		Temperature : -55±2°C Time : 1000h(+48h,-0h) Then measured after exposure in the room condition for 48h±4h.

**8. Specification of Packaging**

**8-1. Appearance and Dimensions (12mm-wide plastic tape)**

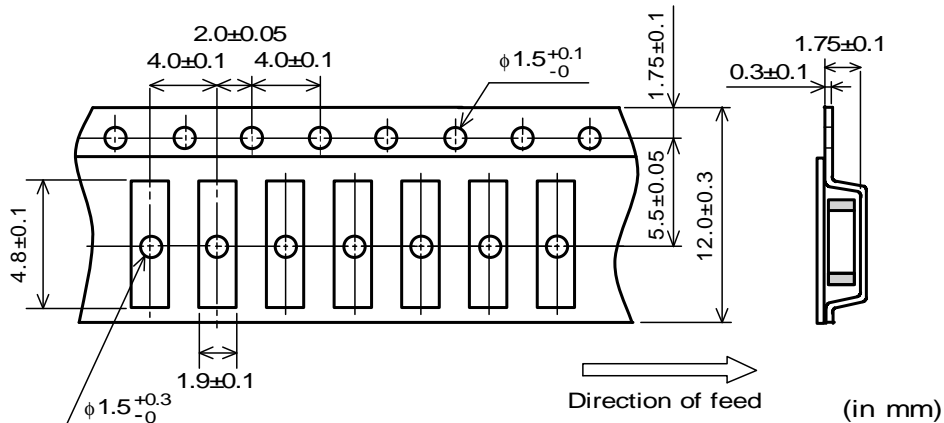

\*Dimension of the Cavity is measured at the bottom side.

(1) Taping

Products shall be packaged in the each embossed cavity of 12mm-wide, 4mm-pitch and plastic tape continuously and sealed by cover tape.

(2) Sprocket hole: The sprocket holes are to the right as the tape is pulled toward the user.

(3) Spliced point: The base tape and top tape have no spliced point.

(4) Missing components number

Missing components number within 0.1% of the number per reel or 1 pc., whichever is greater, and are not continuous. The specified quantity per reel is kept.

**8-2. Tape Strength**

(1) Pull Strength

Plastic tape	5N min.
Cover tape	10N min.

(2) Peeling off force of Cover tape

0.2N to 0.7N (Minimum value is typical.)

\*Speed of Peeling off:300mm/min

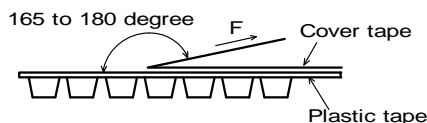



**9-2. Limitation of Applications**

Please contact us before using our products for the applications listed below which require especially high reliability for the prevention of defects which might directly cause damage to the third party's life, body or property.

- |                                  |  |
|----------------------------------|--|
| (1)Aircraft equipment            | (6)Disaster prevention / crime prevention equipment  |
| (2)Aerospace equipment           | (7)Traffic signal equipment  |
| (3)Undersea equipment            | (8)Transportation equipment (vehicles, trains, ships, etc.)  |
| (4)Power plant control equipment | (9)Applications of similar complexity and /or reliability requirements to the applications listed in the above |
| (5)Medical equipment             |  |

**10. Notice**

This product is designed for solder mounting.

Please consult us in advance for applying other mounting method such as conductive adhesive.

**10-1. Land pattern designing**

- Standard land dimensions (Flow and Reflow soldering)

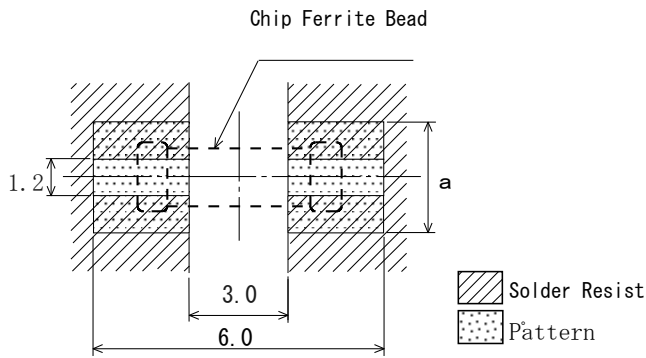

Rated Current (A)	Land pad thickness and dimension a		
	18μm	35μm	70μm
1.5/2	1.2	1.2	1.2
3.5	2.4	1.2	1.2
6	6.4	3.3	1.65

(in mm)

\*The excessive heat by land pads may cause deterioration at joint of products with substrate.

- Land dimensions on Flow soldering for 2.5mm pitch mounting

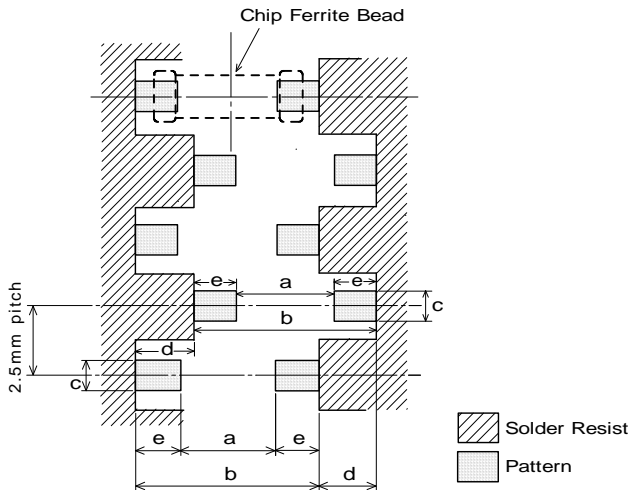

\*Taking land pad thickness and rated current into account.

a	b	c	d	e
3.0	6.0	1.2	1.8	1.5

(in mm)

\*The pattern shall be designed to above drawing to prevent causing the solder bridge when products are mounted by 2.5mm pitch flow soldering.

**10-2. Soldering Conditions**

Products can be applied to reflow and flow soldering.

(1) Flux, Solder

Flux	Use rosin-based flux, but not highly acidic flux (with chlorine content exceeding 0.2(wt)%.) Do not use water-soluble flux.
Solder	Use Sn-3.0Ag-0.5Cu solder Standard thickness of solder paste : 100 μm to 200 μm

(2) Soldering conditions

- Pre-heating should be in such a way that the temperature difference between solder and ferrite surface is limited to 150°C max. Also cooling into solvent after soldering should be in such a way that the temperature difference is limited to 100°C max.  
Insufficient pre-heating may cause cracks on the ferrite, resulting in the deterioration of product quality.
- Standard soldering profile and the limit soldering profile is as follows.  
The excessive limit soldering conditions may cause leaching of the electrode and / or resulting in the deterioration of product quality.

(3) soldering profile

Flow soldering profile

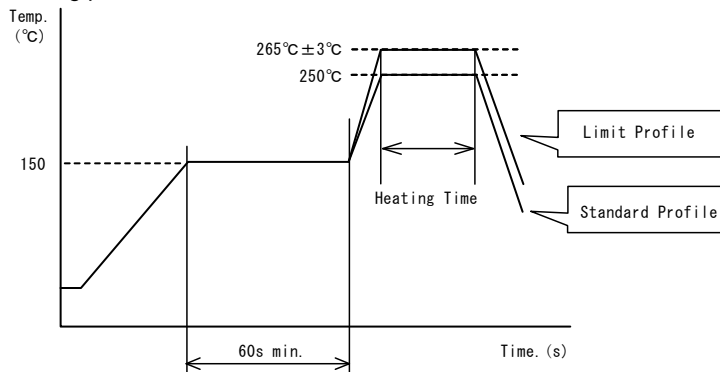

	Standard Profile	Limit Profile
Pre-heating	150°C、60s min.	
Heating	250°C、4~6s	265°C ± 3°C、5s max.
Cycle of flow	2 times	2 times

Reflow soldering profile

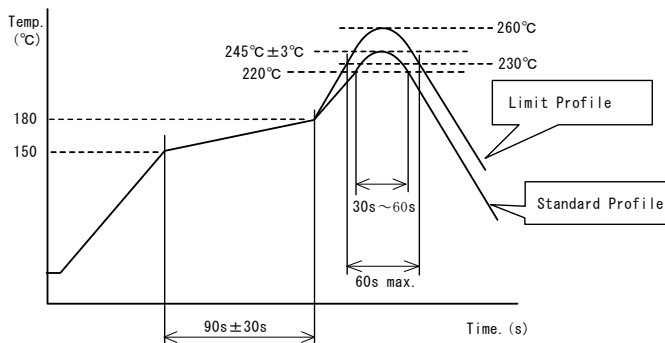

	Standard Profile	Limit Profile
Pre-heating	150~180°C、90s ± 30s	
Heating	above 220°C、30s ~ 60s	above 230°C、60s max.
Peak temperature	245 ± 3°C	260°C, 10s
Cycle of reflow	2 times	2 times

**10-3. Reworking with soldering iron**

- Pre-heating: 150°C, 1 min
- Tip temperature: 350°C max.
- Soldering time : 3(+1, -0) seconds.
- Soldering iron output: 80W max.
- Tip diameter:  $\phi$  3mm max.
- Times : 2times max.

Note :Do not directly touch the products with the tip of the soldering iron in order to prevent the crack on the ferrite material due to the thermal shock.

**10-4. Solder Volume**

Solder shall be used not to be exceed as shown below.

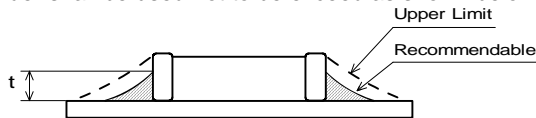

$$\frac{1}{3}T \leq t \leq T$$

(T: Chip thickness)

Accordingly increasing the solder volume, the mechanical stress to product is also increased. Exceeding solder volume may cause the failure of mechanical or electrical performance.

**10-5. Attention regarding P.C.B. bending**

The following shall be considered when designing and laying out P.C.B.'s.

- (1) P.C.B. shall be designed so that products are not subject to the mechanical stress for board warpage.  
<Products direction>

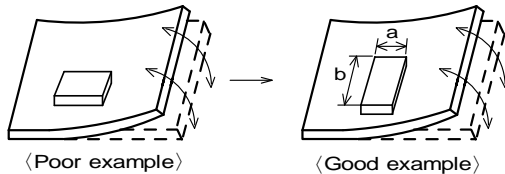

Products shall be located in the sideways direction (Length:a<b) to the mechanical stress.

- (2) Products location on P.C.B. separation.

Products (A,B,C,D) shall be located carefully so that products are not subject to the mechanical stress due to warping the board. Because they may be subjected the mechanical stress in order of  $A > C > B \cong D$ .

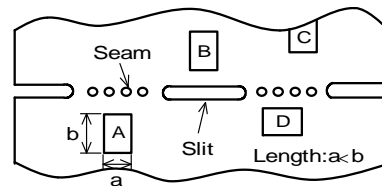
**10-6. Mounting density**

Add special attention to radiating heat of products when mounting the inductor near the products with heating. The excessive heat by other products may cause deterioration at joint of this product with substrate.

**10-7. Operating Environment**

Do not use this product under the following environmental conditions, on deterioration of the Insulation Resistance of the Ferrite material and/or corrosion of Inner Electrode may result from the use.

- (1) in the corrodible atmosphere (acidic gases, alkaline gases, chlorine, sulfur gases, organic gases and etc.)
- (2) in the atmosphere where liquid such as organic solvent, may splash on the products.
- (3) in the atmosphere where the temperature / humidity changes rapidly and it is easy to dew.

**10-8. Resin coating**

The impedance value may change and/or it may affect on the product's performance due to high cure-stress of resin to be used for coating / molding products. So please pay your careful attention when you select resin. In prior to use, please make the reliability evaluation with the product mounted in your application set.

**10-9. Cleaning Conditions**

Products shall be cleaned on the following conditions.

- (1) Cleaning temperature shall be limited to 60°C max. (40°C max. for IPA.)
- (2) Ultrasonic cleaning shall comply with the following conditions, avoiding the resonance phenomenon at the mounted products and P.C.B.  
Power:20W/ℓ max. Frequency:28kHz to 40kHz Time:5 min max.
- (3) Cleaner
  - 1.Alternative cleaner
    - Isopropyl alcohol (IPA)
  - 2.Aqueous agent
    - PINE ALPHA ST-100S
- (4) There shall be no residual flux and residual cleaner after cleaning.  
In the case of using aqueous agent, products shall be dried completely after rinse with de-ionized water in order to remove the cleaner.
- (5) Other cleaning  
Please contact us.

**10-10. Handling of a substrate**

After mounting products on a substrate, do not apply any stress to the product caused by bending or twisting to the substrate when cropping the substrate, inserting and removing a connector from the substrate or tightening screw to the substrate.

Excessive mechanical stress may cause cracking in the product.

**10-11. Storage Conditions**

- (1) Storage period  
Use the products within 6 months after delivered.  
Solderability should be checked if this period is exceeded.
- (2) Storage conditions
  - Products should be stored in the warehouse on the following conditions.  
Temperature : -10°C to 40°C  
Humidity : 15% to 85% relative humidity  
No rapid change on temperature and humidity
  - Don't keep products in corrosive gases such as sulfur, chlorine gas or acid, or it may cause oxidization of electrode, resulting in poor solderability.
  - Products should be stored on the palette for the prevention of the influence from humidity, dust and so on.
  - Products should be stored in the warehouse without heat shock, vibration, direct sunlight and so on.
  - Products should be stored under the airtight packaged condition.
- (3) Delivery  
Care should be taken when transporting or handling product to avoid excessive vibration or mechanical shock.

**11. ⚠ Note**

- (1) Please make sure that your product has been evaluated in view of your specifications with our product being mounted to your product.
- (2) You are requested not to use our product deviating from the reference specifications.
- (3) The contents of this reference specification are subject to change without advance notice. Please approve our product specifications or transact the approval sheet for product specifications before ordering.



# Mouser Electronics

Authorized Distributor

Click to View Pricing, Inventory, Delivery & Lifecycle Information:

[Murata:](#)

[BLM41PG102SN1L](#) [BLM41PG181SN1L](#) [BLM41PG600SN1L](#) [BLM41PG750SN1L](#) [BLM41PG471SN1L](#)  
[BLM41PG102SN1B](#)