

# MAX5723/MAX5724/ MAX5725

# Ultra-Small, Octal-Channel, 8-/10-/12-Bit Buffered Output DACs with Internal Reference and SPI Interface

## General Description

The MAX5723/MAX5724/MAX5725 8-channel, low-power, 8-/10-/12-bit, voltage-output digital-to-analog converters (DACs) include output buffers and an internal 3ppm/°C reference that is selectable to be 2.048V, 2.500V, or 4.096V. The MAX5723/MAX5724/MAX5725 accept a wide supply voltage range of 2.7V to 5.5V with extremely low power (6mW) consumption to accommodate most low-voltage applications. A precision external reference input allows rail-to-rail operation and presents a 100kΩ (typ) load to an external reference.

The MAX5723/MAX5724/MAX5725 have a fast 50MHz, 4-wire SPI/QSPI™/MICROWIRE/DSP-compatible serial interface that operates at clock rates up to 50MHz. The DAC output is buffered and has a low supply current of less than 250μA per channel and a low offset error of ±0.5mV (typ). On power-up, the MAX5723/MAX5724/MAX5725 reset the DAC outputs to zero or midscale based on the status of M $\bar{Z}$  logic input, providing flexibility for a variety of control applications. The internal reference is initially powered down to allow use of an external reference. The MAX5723/MAX5724/MAX5725 allow simultaneous output updates using software LOAD commands or the hardware load DAC logic input (LDAC).

The MAX5723/MAX5724/MAX5725 feature a programmable watchdog function which can be enabled to monitor the I/O interface for activity and integrity.

A clear logic input (CLR) allows the contents of the CODE and the DAC registers to be cleared asynchronously and simultaneously sets the DAC outputs to the programmable default value. The MAX5723/MAX5724/MAX5725 are available in a 20-pin TSSOP and an ultra-small, 20-bump WLP package and are specified over the -40°C to +125°C temperature range.

## Applications

- Programmable Voltage and Current Sources
- Gain and Offset Adjustment
- Automatic Tuning and Optical Control
- Power Amplifier Control and Biasing
- Process Control and Servo Loops
- Portable Instrumentation

QSPI is a trademark of Motorola, Inc.

μMAX is a registered trademark of Maxim Integrated Products, Inc.

## Benefits and Features

- Eight High-Accuracy DAC Channels
  - 12-Bit Accuracy Without Adjustment
  - ±1 LSB INL Buffered Voltage Output
  - Guaranteed Monotonic Over All Operating Conditions
  - Independent Mode Settings for Each DAC
- Three Precision Selectable Internal References
  - 2.048V, 2.500V, or 4.096V
- Internal Output Buffer
  - Rail-to-Rail Operation with External Reference
  - 4.5μs Settling Time
  - Outputs Directly Drive 2kΩ Loads
- Small 6.5mm x 4.4mm 20-Pin TSSOP or Ultra-Small 2.5mm x 2.3mm 20-Bump WLP Package
- Wide 2.7V to 5.5V Supply Range
- Separate 1.8V to 5.5V V<sub>DDIO</sub> Power-Supply Input
- Fast 50MHz 4-Wire SPI/QSPI/MICROWIRE/DSP-Compatible Serial Interface
- Programmable Interface Watchdog Timer
- Pin-Selectable Power-On-Reset to Zero-Scale or Midscale DAC Output
- $\overline{\text{LDAC}}$  and  $\overline{\text{CLR}}$  for Asynchronous DAC Control
- Three Selectable Power-Down Output Impedances
  - 1kΩ, 100kΩ, or High Impedance

## Functional Diagram

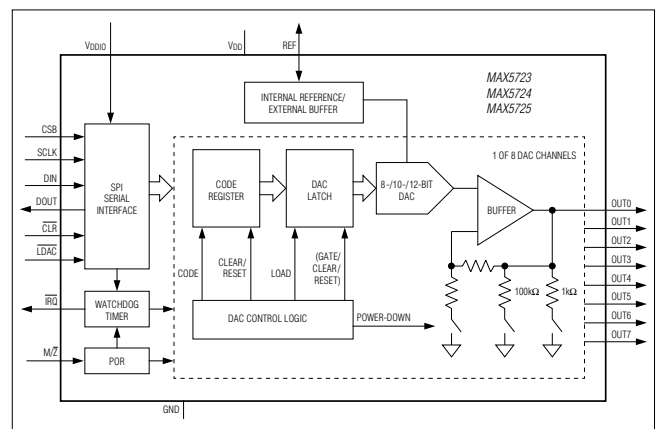

**Ordering Information** appears at end of data sheet.

# MAX5723/MAX5724/ MAX5725

# Ultra-Small, Octal-Channel, 8-/10-/12-Bit Buffered Output DACs with Internal Reference and SPI Interface

## Absolute Maximum Ratings

$V_{DD}$ ,  $V_{DDIO}$  to GND ..... -0.3V to +6V  
 $OUT_{-}$ , REF to GND ..... 0.3V to the lower of  
 ( $V_{DD} + 0.3V$ ) and +6V  
 $SCLK$ ,  $CSB$ ,  $\overline{IRQ}$ ,  $M\overline{Z}$ ,  $\overline{LDAC}$ ,  $\overline{CLR}$  to GND ..... -0.3V to +6V  
 $DIN$ ,  $DOUT$  to GND ..... -0.3V to the lower of  
 ( $V_{DDIO} + 0.3V$ ) and +6V  
 Continuous Power Dissipation ( $T_A = +70^{\circ}C$ )  
 TSSOP (derate at 13.6mW/ $^{\circ}C$  above 70 $^{\circ}C$ ) ..... 1084mW  
 WLP (derate at 21.3mW/ $^{\circ}C$  above 70 $^{\circ}C$ ) ..... 1700mW

Maximum Continuous Current into Any Pin .....  $\pm 50mA$   
 Operating Temperature .....  $-40^{\circ}C$  to  $+125^{\circ}C$   
 Storage Temperature .....  $-65^{\circ}C$  to  $+150^{\circ}C$   
 Lead Temperature (TSSOP only) (soldering, 10s) .....  $+300^{\circ}C$   
 Soldering Temperature (reflow) .....  $+260^{\circ}C$

Stresses beyond those listed under "Absolute Maximum Ratings" may cause permanent damage to the device. These are stress ratings only, and functional operation of the device at these or any other conditions beyond those indicated in the operational sections of the specifications is not implied. Exposure to absolute maximum rating conditions for extended periods may affect device reliability.

## Package Thermal Characteristics (Note 1)

TSSOP  
 Junction-to-Ambient Thermal Resistance ( $\theta_{JA}$ ) ..... 73.8 $^{\circ}C/W$   
 Junction-to-Case Thermal Resistance ( $\theta_{JC}$ ) ..... 20 $^{\circ}C/W$

WLP  
 Junction-to-Ambient Thermal Resistance ( $\theta_{JA}$ )  
 (Note 2) ..... 47 $^{\circ}C/W$

- Note 1:** Package thermal resistances were obtained using the method described in JEDEC specification JESD51-7, using a four-layer board. For detailed information on package thermal considerations, refer to [www.maximintegrated.com/thermal-tutorial](http://www.maximintegrated.com/thermal-tutorial).  
**Note 2:** Visit [www.maximintegrated.com/app-notes/index.mvp/id/1891](http://www.maximintegrated.com/app-notes/index.mvp/id/1891) for information about the thermal performance of WLP packaging.

## Electrical Characteristics

( $V_{DD} = 2.7V$  to  $5.5V$ ,  $V_{DDIO} = 1.8V$  to  $5.5V$ ,  $V_{GND} = 0V$ ,  $C_L = 200pF$ ,  $R_L = 2k\Omega$ ,  $T_A = -40^{\circ}C$  to  $+125^{\circ}C$ , unless otherwise noted.)  
 (Note 3)

PARAMETER	SYMBOL	CONDITIONS	MIN	TYP	MAX	UNITS
<b>DC PERFORMANCE (Note 4)</b>						
Resolution and Monotonicity	N	MAX5723	8			Bits
		MAX5724	10			
		MAX5725	12			
Integral Nonlinearity (Note 5)	INL	MAX5723	-0.25	$\pm 0.05$	+0.25	LSB
		MAX5724	-0.5	$\pm 0.2$	+0.5	
		MAX5725	-1	$\pm 0.5$	+1	
Differential Nonlinearity (Note 5)	DNL	MAX5723	-0.25	$\pm 0.05$	+0.25	LSB
		MAX5724	-0.5	$\pm 0.1$	+0.5	
		MAX5725	-1	$\pm 0.2$	+1	
Offset Error (Note 6)	OE		-5	$\pm 0.5$	+5	mV
Offset Error Drift				$\pm 10$		$\mu V/^{\circ}C$
Gain Error (Note 6)	GE		-1.0	$\pm 0.1$	+1.0	%FS
Gain Temperature Coefficient		With respect to $V_{REF}$		$\pm 3.0$		ppm of FS/ $^{\circ}C$

**Electrical Characteristics (continued)**

( $V_{DD} = 2.7V$  to  $5.5V$ ,  $V_{DDIO} = 1.8V$  to  $5.5V$ ,  $V_{GND} = 0V$ ,  $C_L = 200pF$ ,  $R_L = 2k\Omega$ ,  $T_A = -40^\circ C$  to  $+125^\circ C$ , unless otherwise noted.)  
(Note 3)

PARAMETER	SYMBOL	CONDITIONS		MIN	TYP	MAX	UNITS
Zero-Scale Error				0		+10	mV
Full-Scale Error		With respect to $V_{REF}$		-0.5		+0.5	%FS
<b>DAC OUTPUT CHARACTERISTICS</b>							
Output Voltage Range (Note 7)		No load		0		$V_{DD}$	V
		2k $\Omega$ load to GND		0		$V_{DD} - 0.2$	
		2k $\Omega$ load to $V_{DD}$		0.2		$V_{DD}$	
Load Regulation		$V_{OUT} = V_{FS}/2$	$V_{DD} = 3V \pm 10\%$ , $ I_{OUT}  \leq 5mA$		300		$\mu V/mA$
			$V_{DD} = 5V \pm 10\%$ , $ I_{OUT}  \leq 10mA$		300		
DC Output Impedance		$V_{OUT} = V_{FS}/2$	$V_{DD} = 3V \pm 10\%$ , $ I_{OUT}  \leq 5mA$		0.3		$\Omega$
			$V_{DD} = 5V \pm 10\%$ , $ I_{OUT}  \leq 10mA$		0.3		
Maximum Capacitive Load Handling	$C_L$				500		pF
Resistive Load Handling	$R_L$			2			k $\Omega$
Short-Circuit Output Current		$V_{DD} = 5.5V$	Sourcing (output shorted to GND)		30		mA
			Sinking (output shorted to $V_{DD}$ )		50		
DC Power-Supply Rejection		$V_{DD} = 3V \pm 10\%$ or $5V \pm 10\%$			100		$\mu V/V$
<b>DYNAMIC PERFORMANCE</b>							
Voltage-Output Slew Rate	SR	Positive and negative			1.0		V/ $\mu s$
Voltage-Output Settling Time		$1/4$ scale to $3/4$ scale, to $\leq 1$ LSB, MAX5723			2.2		$\mu s$
		$1/4$ scale to $3/4$ scale, to $\leq 1$ LSB, MAX5724			2.6		
		$1/4$ scale to $3/4$ scale, to $\leq 1$ LSB, MAX5725			4.5		
DAC Glitch Impulse		Major code transition (code x7FF to x800)			7		nV*s
Channel-to-Channel Feedthrough (Note 8)		Internal reference			3.3		nV*s
		External reference			4.07		
Digital Feedthrough		Midscale code, all digital inputs from 0V to $V_{DDIO}$			0.2		nV*s
Power-Up Time		Startup calibration time (Note 9)			200		$\mu s$
		From power-down			50		$\mu s$

**Electrical Characteristics (continued)**

( $V_{DD} = 2.7V$  to  $5.5V$ ,  $V_{DDIO} = 1.8V$  to  $5.5V$ ,  $V_{GND} = 0V$ ,  $C_L = 200pF$ ,  $R_L = 2k\Omega$ ,  $T_A = -40^\circ C$  to  $+125^\circ C$ , unless otherwise noted.)  
(Note 3)

PARAMETER	SYMBOL	CONDITIONS		MIN	TYP	MAX	UNITS
Output Voltage-Noise Density (DAC Output at Midscale)		External reference	f = 1kHz		90		nV/ $\sqrt{Hz}$
			f = 10kHz		82		
		2.048V internal reference	f = 1kHz		112		
			f = 10kHz		102		
		2.5V internal reference	f = 1kHz		125		
			f = 10kHz		110		
		4.096V internal reference	f = 1kHz		160		
			f = 10kHz		145		
Integrated Output Noise (DAC Output at Midscale)		External reference	f = 0.1Hz to 10Hz		12		$\mu V_{P-P}$
			f = 0.1Hz to 10kHz		76		
			f = 0.1Hz to 300kHz		385		
		2.048V internal reference	f = 0.1Hz to 10Hz		14		
			f = 0.1Hz to 10kHz		91		
			f = 0.1Hz to 300kHz		450		
		2.5V internal reference	f = 0.1Hz to 10Hz		15		
			f = 0.1Hz to 10kHz		99		
			f = 0.1Hz to 300kHz		470		
		4.096V internal reference	f = 0.1Hz to 10Hz		16		
			f = 0.1Hz to 10kHz		124		
			f = 0.1Hz to 300kHz		490		
Output Voltage-Noise Density (DAC Output at Full Scale)		External reference	f = 1kHz		114		nV/ $\sqrt{Hz}$
			f = 10kHz		99		
		2.048V internal reference	f = 1kHz		175		
			f = 10kHz		153		
		2.5V internal reference	f = 1kHz		200		
			f = 10kHz		174		
		4.096V internal reference	f = 1kHz		295		
			f = 10kHz		255		
Integrated Output Noise (DAC Output at Full Scale)		External reference	f = 0.1Hz to 10Hz		13		$\mu V_{P-P}$
			f = 0.1Hz to 10kHz		94		
			f = 0.1Hz to 300kHz		540		
		2.048V internal reference	f = 0.1Hz to 10Hz		19		
			f = 0.1Hz to 10kHz		143		
			f = 0.1Hz to 300kHz		685		
		2.5V internal reference	f = 0.1Hz to 10Hz		21		
			f = 0.1Hz to 10kHz		159		
			f = 0.1Hz to 300kHz		705		
		4.096V internal reference	f = 0.1Hz to 10Hz		26		
			f = 0.1Hz to 10kHz		213		
			f = 0.1Hz to 300kHz		750		

MAX5723/MAX5724/  
MAX5725

Ultra-Small, Octal-Channel, 8-/10-/12-Bit  
Buffered Output DACs with Internal  
Reference and SPI Interface

Electrical Characteristics (continued)

( $V_{DD} = 2.7V$  to  $5.5V$ ,  $V_{DDIO} = 1.8V$  to  $5.5V$ ,  $V_{GND} = 0V$ ,  $C_L = 200pF$ ,  $R_L = 2k\Omega$ ,  $T_A = -40^\circ C$  to  $+125^\circ C$ , unless otherwise noted.)  
(Note 3)

PARAMETER	SYMBOL	CONDITIONS	MIN	TYP	MAX	UNITS	
<b>REFERENCE INPUT</b>							
Reference Input Range	$V_{REF}$		1.24		$V_{DD}$	V	
Reference Input Current	$I_{REF}$	$V_{REF} = V_{DD} = 5.5V$		55	74	$\mu A$	
Reference Input Impedance	$R_{REF}$		75	100		$k\Omega$	
<b>REFERENCE OUTPUT</b>							
Reference Output Voltage	$V_{REF}$	$V_{REF} = 2.048V$ , $T_A = +25^\circ C$	2.043	2.048	2.053	V	
		$V_{REF} = 2.5V$ , $T_A = +25^\circ C$	2.494	2.500	2.506		
		$V_{REF} = 4.096V$ , $T_A = +25^\circ C$	4.086	4.096	4.106		
Reference Temperature Coefficient (Note 10)		MAX5725A		$\pm 3$	$\pm 10$	ppm/ $^\circ C$	
		MAX5723/MAX5724/MAX5725B		$\pm 10$	$\pm 25$		
Reference Drive Capacity		External load		25		$k\Omega$	
Reference Capacitive Load Handling				200		pF	
Reference Load Regulation		$I_{SOURCE} = 0$ to $500\mu A$		2		mV/mA	
Reference Line Regulation				0.05		mV/V	
<b>POWER REQUIREMENTS</b>							
Supply Voltage	$V_{DD}$	$V_{REF} = 4.096V$	4.5		5.5	V	
		All other options	2.7		5.5		
I/O Supply Voltage	$V_{DDIO}$		1.8		5.5	V	
Supply Current (Note 11)	$I_{DD}$	Internal reference	$V_{REF} = 2.048V$		1.6	2	mA
			$V_{REF} = 2.5V$		1.7	2.1	
			$V_{REF} = 4.096V$		2.0	2.5	
		External reference	$V_{REF} = 3V$		1.6	2.0	
			$V_{REF} = 5V$		1.9	2.5	
Power-Down Mode Supply Current	$I_{PD}$	All DACs off, internal reference ON		140		$\mu A$	
		All DACs off, internal reference OFF, $T_A = -40^\circ C$ to $+85^\circ C$		0.7	2		
		All DACs off, internal reference OFF, $T_A = +125^\circ C$		2	4		
Digital Supply Current	$I_{DDIO}$	Static logic inputs, all outputs unloaded			1	$\mu A$	
<b>DIGITAL INPUT CHARACTERISTICS (SCLK, DIN, CSB, LDAC, CLR, M/Z)</b>							
Input Leakage Current	$I_{IN}$	$V_{IN} = 0V$ or $V_{DDIO}$ , all inputs except $M/\bar{Z}$ (Note 11)		$\pm 0.1$	$\pm 1$	$\mu A$	
		$V_{IN} = 0V$ or $V_{DD}$ , for $M/\bar{Z}$ (Note 11)					

MAX5723/MAX5724/  
MAX5725

Ultra-Small, Octal-Channel, 8-/10-/12-Bit  
Buffered Output DACs with Internal  
Reference and SPI Interface

Electrical Characteristics (continued)

( $V_{DD} = 2.7V$  to  $5.5V$ ,  $V_{DDIO} = 1.8V$  to  $5.5V$ ,  $V_{GND} = 0V$ ,  $C_L = 200pF$ ,  $R_L = 2k\Omega$ ,  $T_A = -40^\circ C$  to  $+125^\circ C$ , unless otherwise noted.)  
(Note 3)

PARAMETER	SYMBOL	CONDITIONS		MIN	TYP	MAX	UNITS
Input High Voltage	$V_{IH}$	(All inputs except $M/\bar{Z}$ )	$2.2V < V_{DDIO} < 5.5V$	$0.7 \times V_{DDIO}$			V
			$1.8V < V_{DDIO} < 2.2V$	$0.8 \times V_{DDIO}$			V
		$2.7V < V_{DD} < 5.5V$ (for $M/\bar{Z}$ )		$0.7 \times V_{DD}$			
Input Low Voltage	$V_{IL}$	(All inputs except $M/\bar{Z}$ )	$2.2V < V_{DDIO} < 5.5V$			$0.3 \times V_{DDIO}$	V
			$1.8V < V_{DDIO} < 2.2V$			$0.2 \times V_{DDIO}$	V
		$2.7V < V_{DD} < 5.5V$ (for $M/\bar{Z}$ )				$0.3 \times V_{DD}$	
Input Capacitance (Note 10)	$C_{IN}$					10	pF
Hysteresis Voltage	$V_H$				0.15		V
<b>DIGITAL OUTPUT (<math>\overline{IRQ}</math>)</b>							
Output Low Voltage	$V_{OL}$	$I_{SINK} = 3mA$				0.2	V
Output Inactive Leakage	$I_{OFF}$				$\pm 0.1$	$\pm 1$	$\mu A$
Output Inactive Capacitance (Note 10)	$C_{OFF}$					10	pF
<b>DIGITAL OUTPUT (DOUT)</b>							
Output High Voltage	$V_{OH}$	$V_{DDIO} > 2.5V$ , $I_{SOURCE} = 3mA$		$V_{DDIO} - 0.2$			V
		$V_{DDIO} > 1.8V$ , $I_{SOURCE} = 2mA$		$V_{DDIO} - 0.2$			
Output Low Voltage	$V_{OL}$	$V_{DDIO} > 2.5V$ , $I_{SINK} = 3mA$				0.2	V
		$V_{DDIO} > 1.8V$ , $I_{SINK} = 2mA$				0.2	
Output Short-Circuit Current	$I_{OSS}$	$I_{SINK}$ , $I_{SOURCE}$			$\pm 100$		mA
Output Three-State Leakage	$I_{OZ}$				$\pm 0.1$	$\pm 1$	$\mu A$
Output Three-State Capacitance	$C_{OZ}$					10	pF
<b>WATCHDOG TIMER CHARACTERISTICS</b>							
Watchdog Timer Period	$t_{WDOSC}$	$V_{DD} = 3V$ , $T_A = +25^\circ C$		0.95	1	1.05	ms
Watchdog Timer Period Supply Drift		$V_{DD} = 2.7V$ to $5.5V$ , $T_A = +25^\circ C$			0.6		%/V
Watchdog Timer Period Temperature Drift		$V_{DD} = 3V$			0.0375		%/°C

**Electrical Characteristics (continued)**

( $V_{DD} = 2.7V$  to  $5.5V$ ,  $V_{DDIO} = 1.8V$  to  $5.5V$ ,  $V_{GND} = 0V$ ,  $C_L = 200pF$ ,  $R_L = 2k\Omega$ ,  $T_A = -40^\circ C$  to  $+125^\circ C$ , unless otherwise noted.)  
(Note 3)

PARAMETER	SYMBOL	CONDITIONS		MIN	TYP	MAX	UNITS
<b>SPI TIMING CHARACTERISTICS</b>							
SCLK Frequency	$f_{SCLK}$	$2.7V < V_{DDIO} < 5.5V$	Write mode	0		50	MHz
			Read mode, strobing on 1 SCLK	0		25	
			Read mode, strobing on $\frac{1}{2}$ SCLK	0		12.5	
		$1.8V < V_{DDIO} < 2.7V$	Write mode	0		33	
			Read mode, strobing on 1 SCLK	0		20	
			Read mode, strobing on $\frac{1}{2}$ SCLK	0		10	
SCLK Period	$t_{SCLK}$	$2.7V < V_{DDIO} < 5.5V$ , write mode		20			ns
		$1.8V < V_{DDIO} < 2.7V$ , write mode		30			
SCLK Pulse Width High	$t_{CH}$			8			ns
SCLK Pulse Width Low	$t_{CL}$			8			ns
CSB Fall to SCLK Fall Setup Time	$t_{CSS0}$	To first SCLK falling edge	$2.7V < V_{DDIO} < 5.5V$	8			ns
			$1.8V < V_{DDIO} < 2.7V$	12			
CSB Fall to SCLK Fall Hold Time	$t_{CSH0}$	Applies to inactive SCLK falling edge preceding the first SCLK falling edge		0			ns
CSB Rise to SCLK Fall Hold Time	$t_{CSH1}$	Applies to the 24th SCLK falling edge		0			ns
CSB Rise to SCLK Fall	$t_{CSA}$	Applies to the 24th SCLK falling edge, aborted sequence		12			ns
SCLK Fall to CSB Fall	$t_{CSF}$	Applies to 24th SCLK falling edge		100			ns
CSB Pulse Width High	$t_{CSPW}$			20			ns
DIN to SCLK Fall Setup Time	$t_{DS}$			5			ns
DIN to SCLK Fall Hold Time	$t_{DH}$			4.5			ns
$\overline{CLR}$ Pulse Width Low	$t_{CLPW}$			20			ns
$\overline{CLR}$ Rise to CSB Fall	$t_{CSC}$	Required for command to be executed		20			ns
$\overline{LDAC}$ Pulse Width Low	$t_{LDPW}$			20			ns
$\overline{LDAC}$ Fall to SCLK Fall Hold	$t_{LDH}$	Applies to 24th SCLK falling edge		20			ns
SCLK Fall to DOUT Transition	$t_{DOT}$	DPHA = 0, $C_{LOAD} = 20pF$	$2.7V < V_{DDIO} < 5.5V$			35	ns
			$1.8V < V_{DDIO} < 2.7V$			40	
SCLK Rise to DOUT Transition	$t_{DOT}$	DPHA = 1, $C_{LOAD} = 20pF$	$2.7V < V_{DDIO} < 5.5V$			35	ns
			$1.8V < V_{DDIO} < 2.7V$			40	

Electrical Characteristics (continued)

( $V_{DD} = 2.7V$  to  $5.5V$ ,  $V_{DDIO} = 1.8V$  to  $5.5V$ ,  $V_{GND} = 0V$ ,  $C_L = 200pF$ ,  $R_L = 2k\Omega$ ,  $T_A = -40^\circ C$  to  $+125^\circ C$ , unless otherwise noted.)  
(Note 3)

PARAMETER	SYMBOL	CONDITIONS	MIN	TYP	MAX	UNITS
SCLK Fall to DOUT Hold	$t_{DOH}$	DPHA = 0, $C_{LOAD} = 0pF$	2			ns
SCLK Rise to DOUT Hold	$t_{DOH}$	DPHA = 1, $C_{LOAD} = 0pF$	2			ns
CSB Fall to DOUT Fall	$t_{DOE}$	Enable time, $C_{LOAD} = 20pF$			20	ns
CSB Rise to DOUT Hi-Z	$t_{DOZ}$	Disable time			20	ns
			$2.7V < V_{DDIO} < 5.5V$		40	

**Note 3:** Electrical specifications are production tested at  $T_A = +25^\circ C$ . Specifications over the entire operating temperature range are guaranteed by design and characterization. Typical specifications are at  $T_A = +25^\circ C$ .

**Note 4:** DC performance is tested without load,  $V_{REF} = V_{DD}$ .

**Note 5:** Linearity is tested with unloaded outputs to within 20mV of GND and  $V_{DD}$ .

**Note 6:** Gain and offset calculated from measurements made with  $V_{REF} = V_{DD}$  at codes 30 and 4065 for MAX5725, codes 8 and 1016 for MAX5724, and codes 2 and 254 for MAX5723.

**Note 7:** Subject to zero- and full-scale error limits and  $V_{REF}$  settings.

**Note 8:** Measured with all other DAC outputs at midscale with one channel transitioning 0 to full scale.

**Note 9:** On power-up, the device initiates an internal 200µs (typ) calibration sequence. All commands issued during this time will be ignored.

**Note 10:** Guaranteed by design.

**Note 11:** All channels active at  $V_{FS}$ , unloaded. Static logic inputs with  $V_{IL} = V_{GND}$  and  $V_{IH} = V_{DDIO}$  for all inputs.

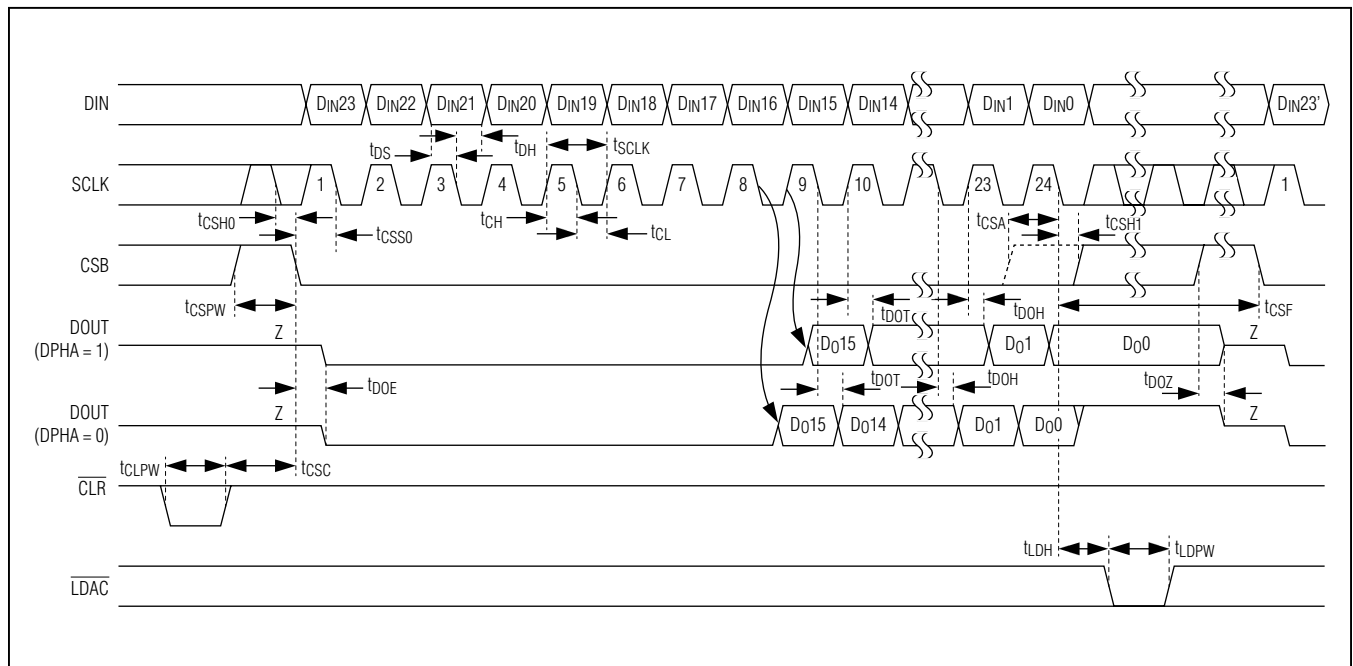
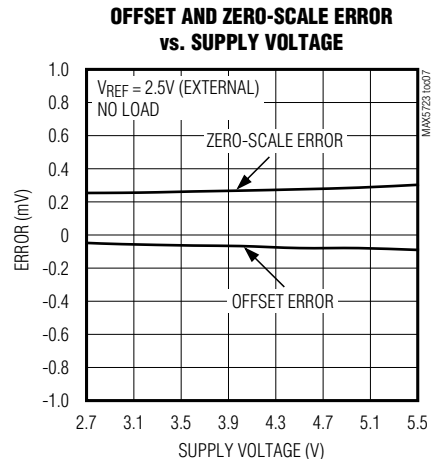
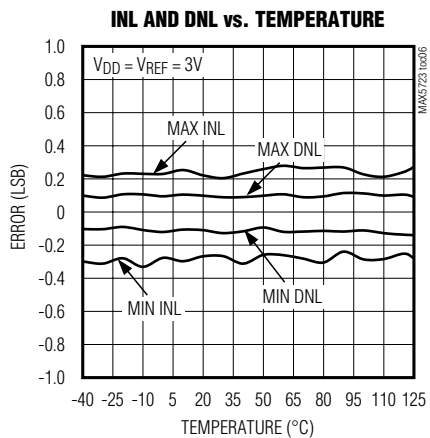
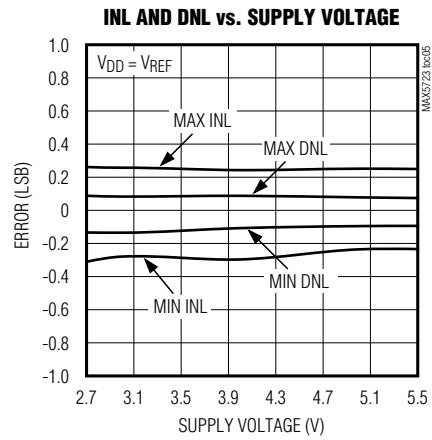
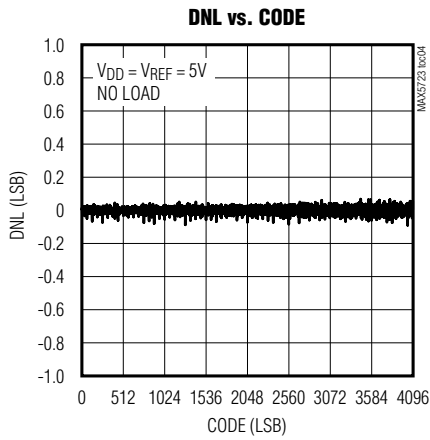
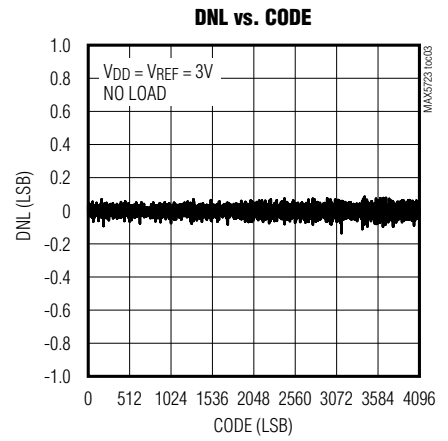
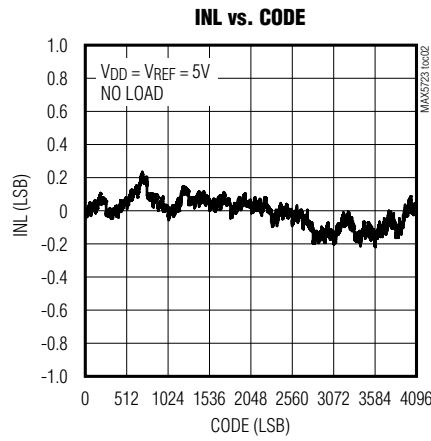
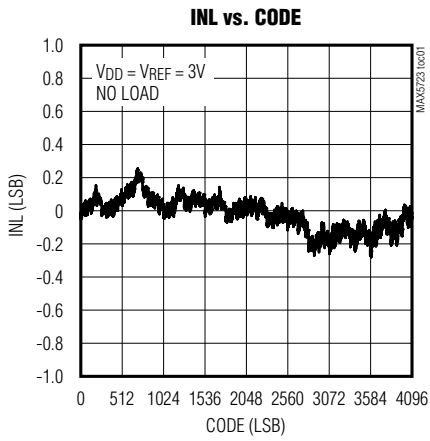

Figure 1. SPI Serial Interface Timing Diagram



Typical Operating Characteristics

(MAX5725, 12-bit performance,  $T_A = +25^\circ\text{C}$ , unless otherwise noted.)



Typical Operating Characteristics (continued)

(MAX5725, 12-bit performance,  $T_A = +25^\circ\text{C}$ , unless otherwise noted.)

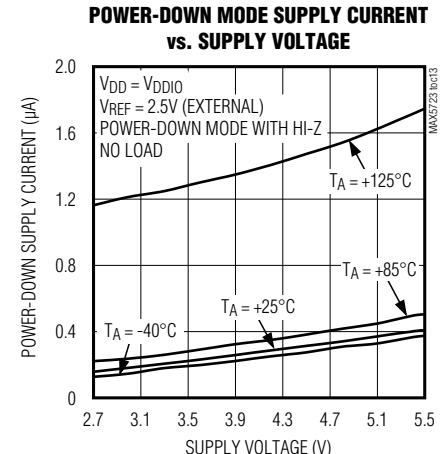
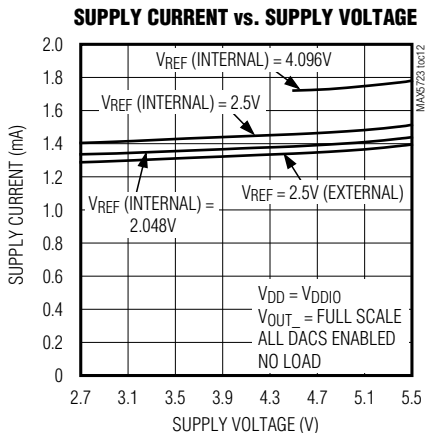
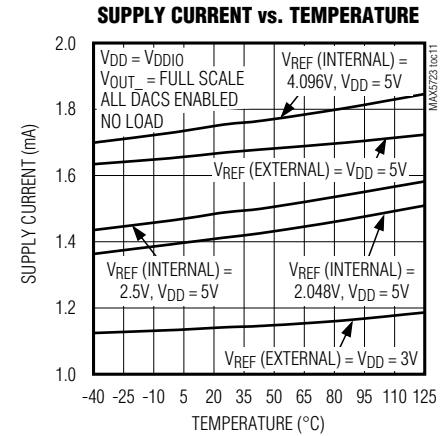
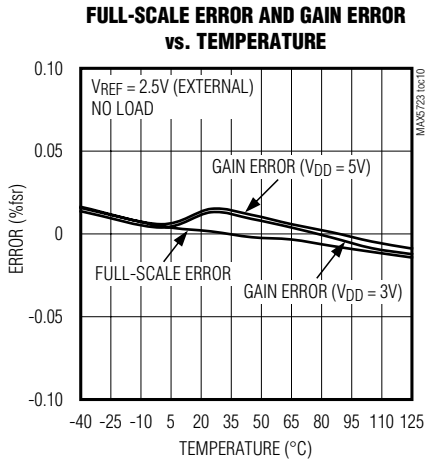
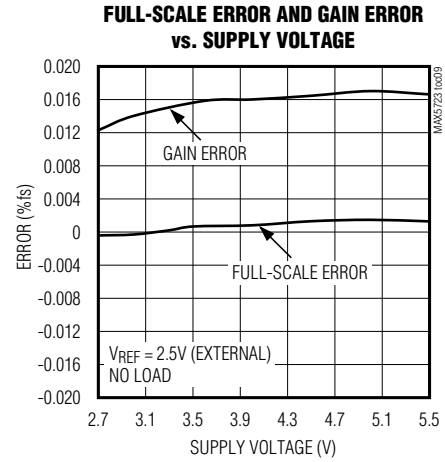
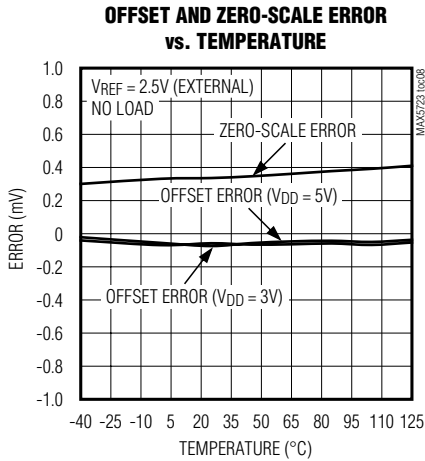

Typical Operating Characteristics (continued)

(MAX5725, 12-bit performance,  $T_A = +25^\circ\text{C}$ , unless otherwise noted.)

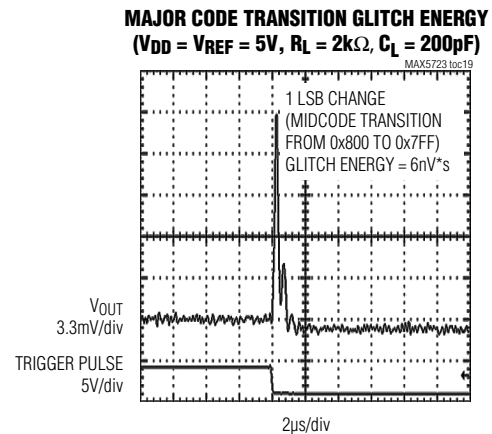
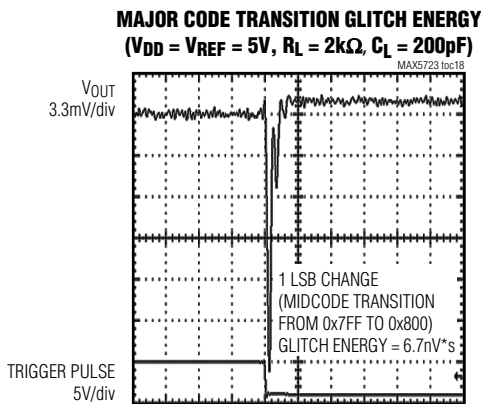
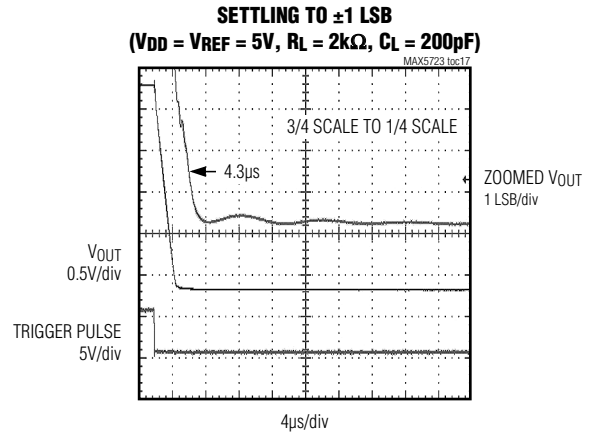
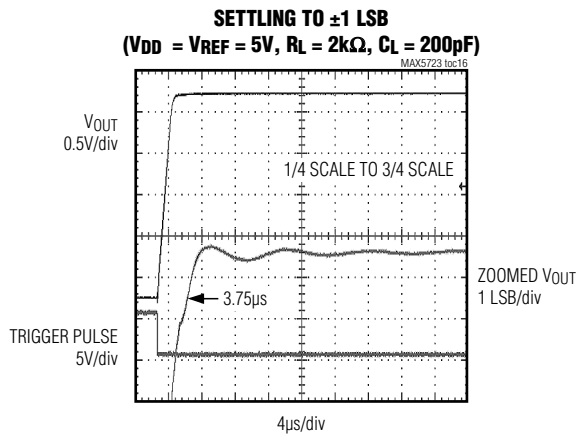
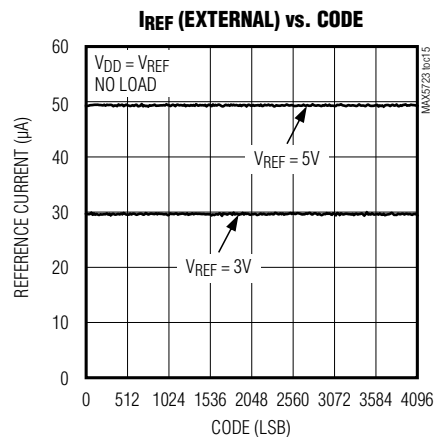
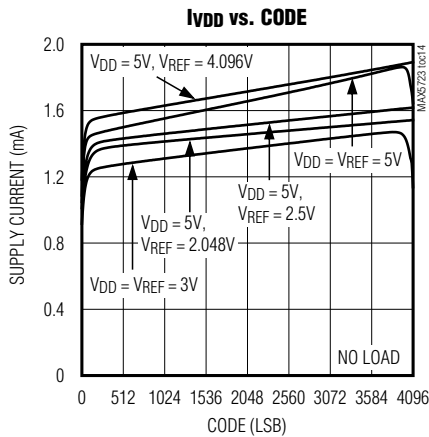

MAX5723/MAX5724/  
MAX5725

Ultra-Small, Octal-Channel, 8-/10-/12-Bit  
Buffered Output DACs with Internal  
Reference and SPI Interface

Typical Operating Characteristics (continued)

(MAX5725, 12-bit performance,  $T_A = +25^\circ\text{C}$ , unless otherwise noted.)

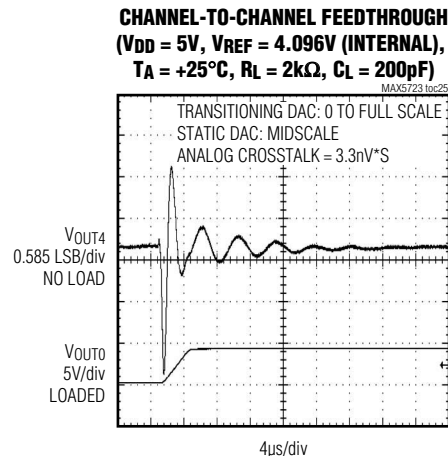
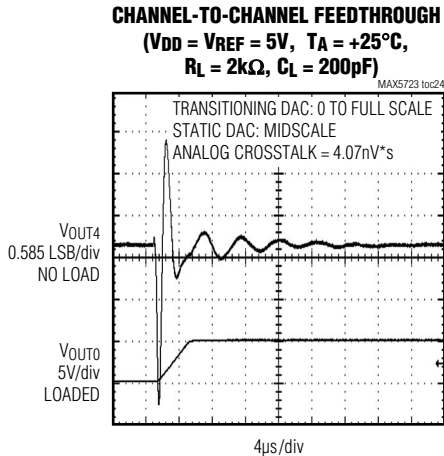
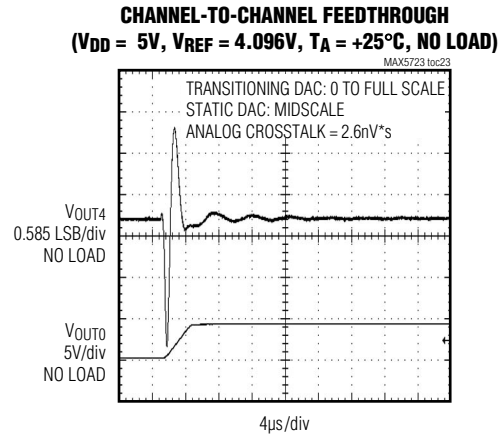
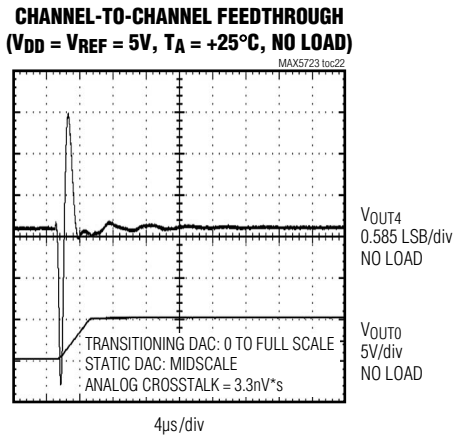
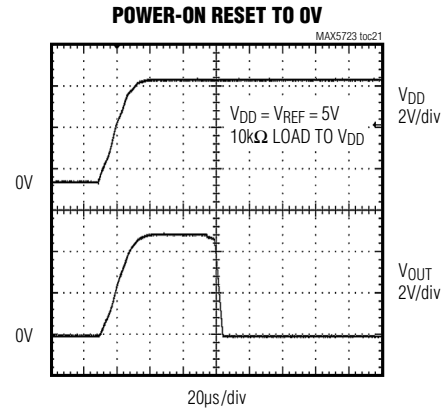
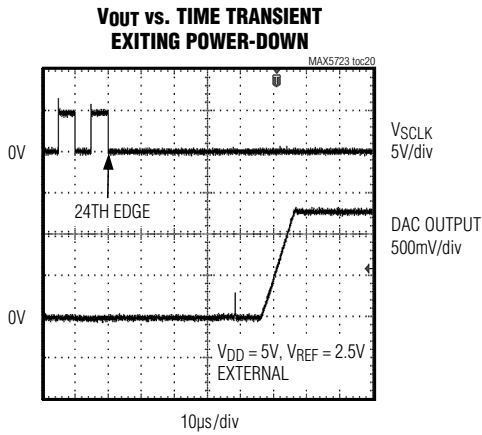

Typical Operating Characteristics (continued)

(MAX5725, 12-bit performance,  $T_A = +25^\circ\text{C}$ , unless otherwise noted.)

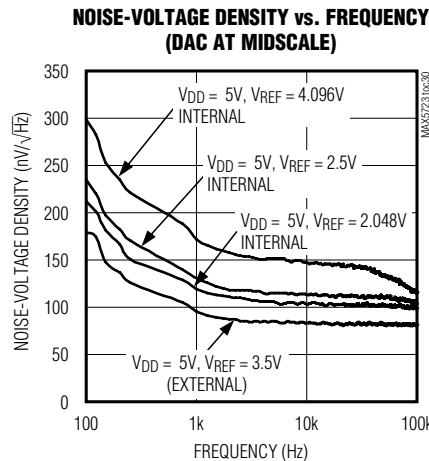
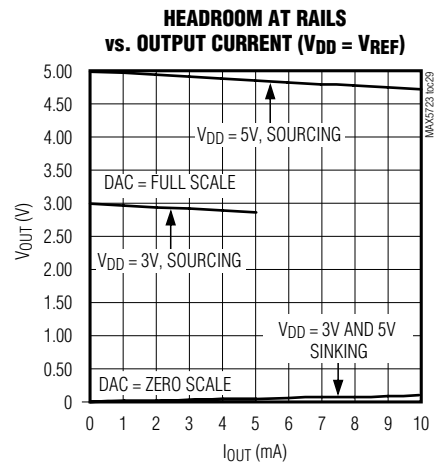
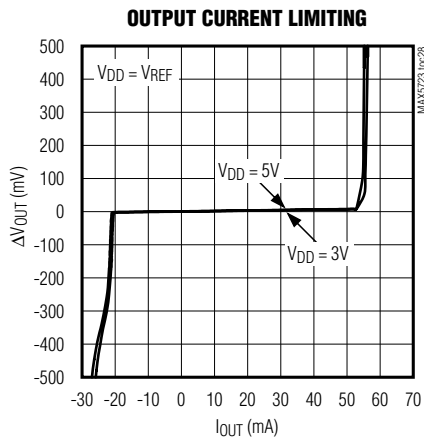
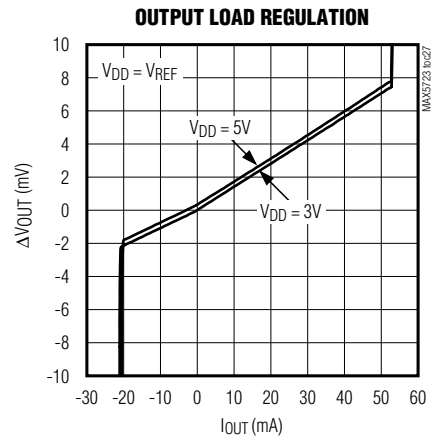
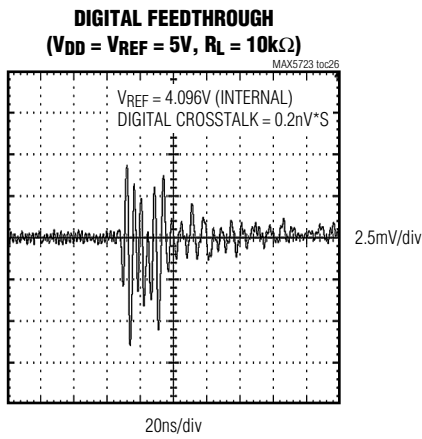

Typical Operating Characteristics (continued)

(MAX5725, 12-bit performance,  $T_A = +25^\circ\text{C}$ , unless otherwise noted.)

0.1Hz TO 10Hz OUTPUT NOISE, EXTERNAL  
REFERENCE ( $V_{DD} = 5\text{V}$ ,  $V_{REF} = 4.5\text{V}$ )

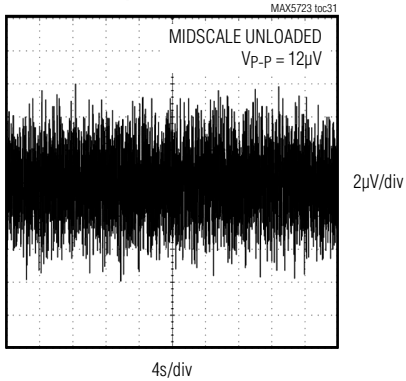

0.1Hz TO 10Hz OUTPUT NOISE, INTERNAL  
REFERENCE ( $V_{DD} = 5\text{V}$ ,  $V_{REF} = 2.048\text{V}$ )

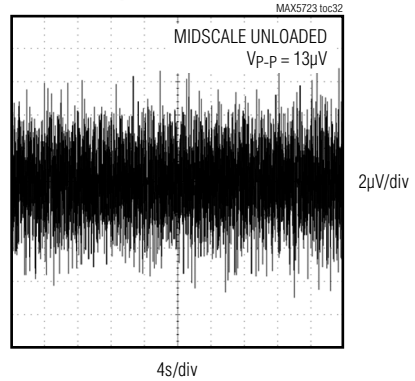

0.1Hz TO 10Hz OUTPUT NOISE, INTERNAL  
REFERENCE ( $V_{DD} = 5\text{V}$ ,  $V_{REF} = 2.5\text{V}$ )

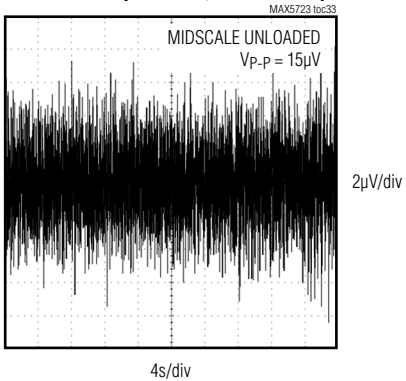

0.1Hz TO 10Hz OUTPUT NOISE, INTERNAL  
REFERENCE ( $V_{DD} = 5\text{V}$ ,  $V_{REF} = 4.096\text{V}$ )

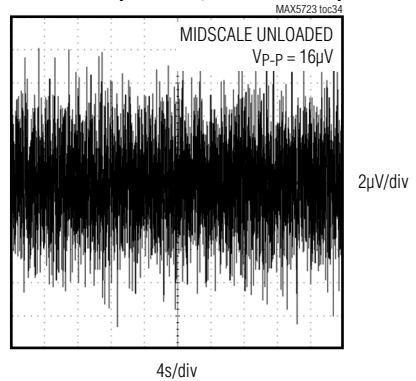

Typical Operating Characteristics (continued)

(MAX5725, 12-bit performance,  $T_A = +25^\circ\text{C}$ , unless otherwise noted.)

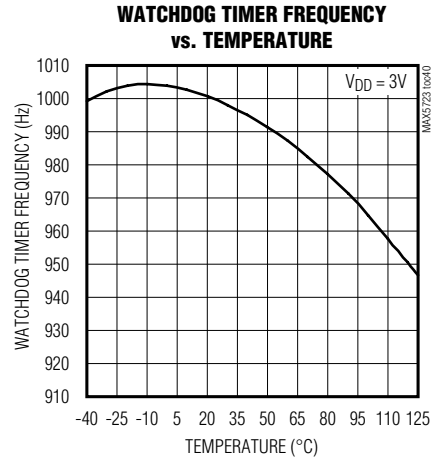
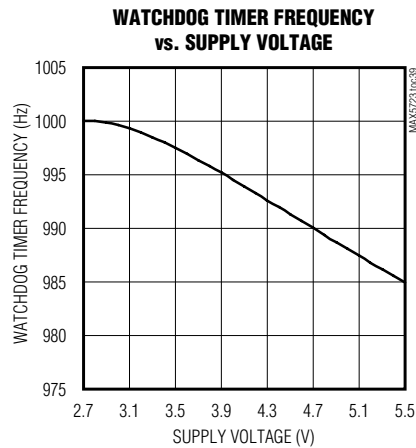
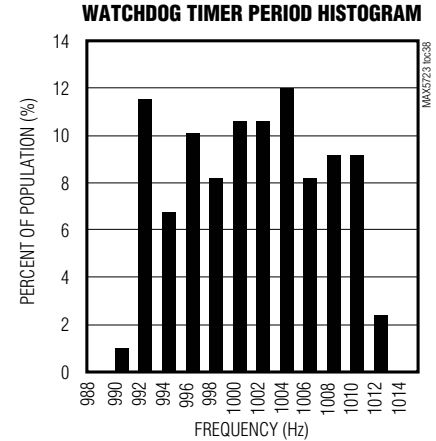
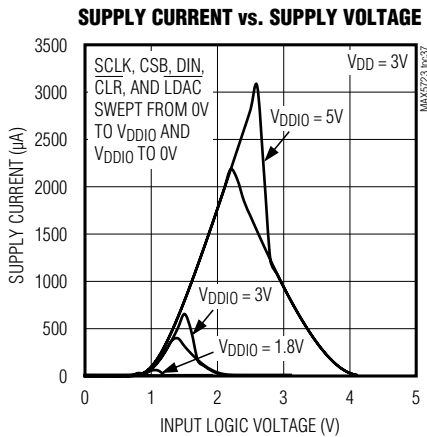
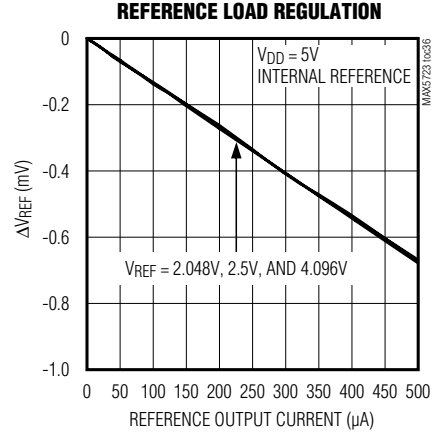
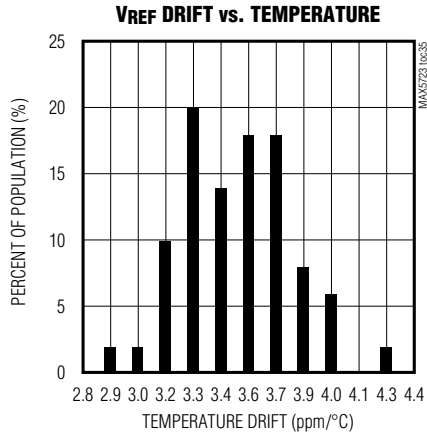

# MAX5723/MAX5724/ MAX5725

## Ultra-Small, Octal-Channel, 8-/10-/12-Bit Buffered Output DACs with Internal Reference and SPI Interface

### Pin Configurations

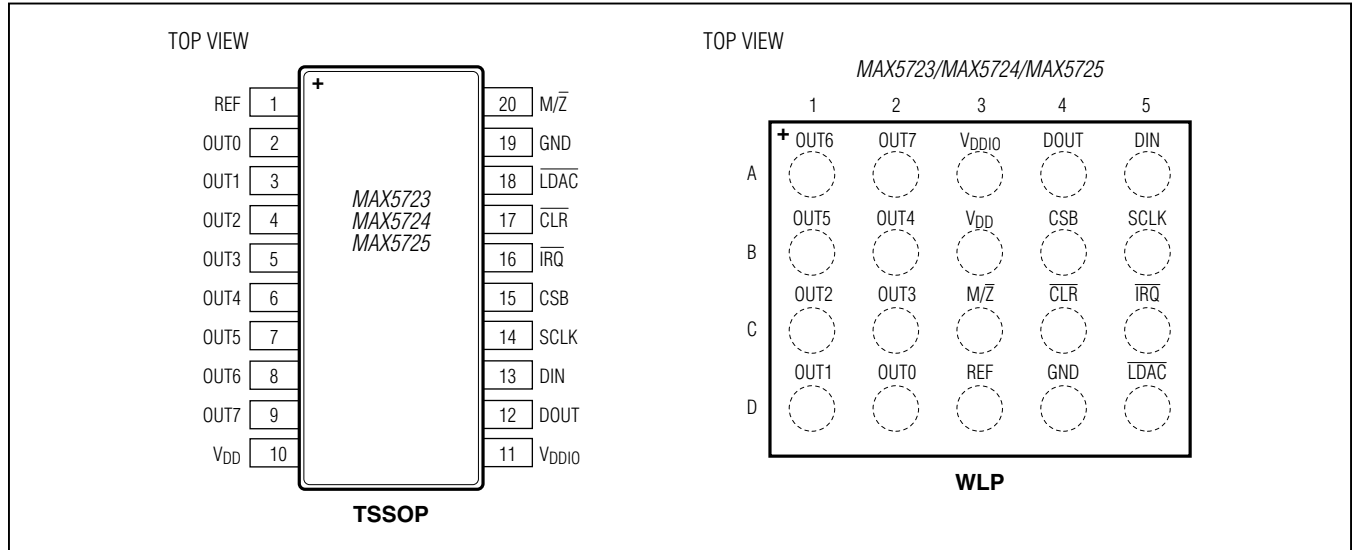

### Pin Description

PIN		NAME	FUNCTION
TSSOP	WLP		
1	D3	REF	Reference Voltage Input/Output
2	D2	DAC0	DAC Channel 0 Voltage Output
3	D1	OUT1	DAC Channel 1 Voltage Output
4	C1	OUT2	DAC Channel 2 Voltage Output
5	C2	OUT3	DAC Channel 3 Voltage Output
6	B2	OUT4	DAC Channel 4 Voltage Output
7	B1	OUT5	DAC Channel 5 Voltage Output
8	A1	OUT6	DAC Channel 6 Voltage Output
9	A2	OUT7	DAC Channel 7 Voltage Output
10	B3	V <sub>DD</sub>	Analog Supply Voltage
11	A3	V <sub>DDIO</sub>	Digital Supply Voltage
12	A4	DOUT	SPI Serial Data Output
13	A5	DIN	SPI Serial Data Input
14	B5	SCLK	SPI Serial Clock Input
15	B4	CSB	SPI Chip-Select Input
16	C5	$\overline{IRQ}$	Active-Low Open Drain Interrupt Output. $\overline{IRQ}$ low indicates watchdog timeout.
17	C4	$\overline{CLR}$	Active-Low Asynchronous DAC Clear Input
18	D5	$\overline{LDAC}$	Active-Low Asynchronous DAC Load Input
19	D4	GND	Ground
20	C3	M $\bar{Z}$	DAC Output Reset Selection. Connect M $\bar{Z}$ to GND for zero-scale and connect M $\bar{Z}$ to V <sub>DD</sub> for midscale.



# MAX5723/MAX5724/ MAX5725

## Detailed Description

The MAX5723/MAX5724/MAX5725 are 8-channel, low-power, 8-/10-/12-bit buffered voltage-output DACs. The 2.7V to 5.5V wide supply voltage range and low-power consumption accommodates most low-power and low-voltage applications. The devices present a 100k $\Omega$  load to the external reference. The internal output buffers allow rail-to-rail operation. An internal voltage reference is available with software-selectable options of 2.048V, 2.500V, or 4.096V. The devices feature a fast 4-wire SPI/QSPI/MICROWIRE/DSP-compatible serial interface to save board space and reduce the complexity in isolated applications interface. The MAX5723/MAX5724/MAX5725 include a serial-in/parallel-out shift register, internal CODE and DAC registers, a power-on-reset (POR) circuit to initialize the DAC outputs to zero scale ( $M/\bar{Z} = 0$ ) or midscale ( $M/\bar{Z} = 1$ ), and control logic.

$\overline{\text{CLR}}$  is available to asynchronously clear the DAC outputs to a user-programmable default value, independent of the serial interface.  $\overline{\text{LDAC}}$  is available to simultaneously update selected DACs on one or more devices. The MAX5723/MAX5724/MAX5725 also feature user-configurable interface watchdog, with status indicated by the  $\overline{\text{IRQ}}$  output.

### DAC Outputs (OUT<sub>n</sub>)

The MAX5723/MAX5724/MAX5725 include internal buffers on all DAC outputs, which provide improved load regulation for the DAC outputs. The output buffers slew at 1V/ $\mu\text{s}$  (typ) and drive resistive loads are as low as 2k $\Omega$  in parallel with as much as 500pF of capacitance. The analog supply voltage ( $V_{\text{DD}}$ ) determines the maximum output voltage range of the devices since it powers the output buffers. Under no-load conditions, the output buffers drive from GND to  $V_{\text{DD}}$ , subject to offset and gain errors. With a 2k $\Omega$  load to GND, the output buffers drive from GND to within 200mV of  $V_{\text{DD}}$ . With a 2k $\Omega$  load to  $V_{\text{DD}}$ , the output buffers drive from  $V_{\text{DD}}$  to within 200mV of GND.

The DAC ideal output voltage is defined by:

$$V_{\text{OUT}} = V_{\text{REF}} \times \frac{D}{2^N}$$

where D = code loaded into the DAC register,  $V_{\text{REF}}$  = reference voltage, N = resolution.

# Ultra-Small, Octal-Channel, 8-/10-/12-Bit Buffered Output DACs with Internal Reference and SPI Interface

## Internal Register Structure

The user interface is separated from the DAC logic to minimize digital feedthrough. Within the serial interface is an input shift register, the contents of which can be routed to control registers, individual, or multiple DACs as determined by the user command.

Within each DAC channel there is a CODE register followed by a DAC latch register (see the [Detailed Functional Diagram](#)). The contents of the CODE register hold pending DAC output settings which can later be loaded into the DAC registers. The CODE register can be updated using both CODE and CODE\_LOAD user commands. The contents of the DAC register hold the current DAC output settings. The DAC register can be updated directly from the serial interface using the CODE\_LOAD commands or can upload the current contents of the CODE register using LOAD commands or the  $\overline{\text{LDAC}}$  logic input.

The contents of both CODE and DAC registers are maintained during power-down states, so that when the DACs are powered on, they return to their previously stored output settings. Any CODE or LOAD commands issued during power-down states continue to update the register contents.

Once the device is powered up, each DAC channel can be independently programmed with a desired RETURN value using the RETURN command. This becomes the value the CODE and DAC registers will use in the event of any watchdog, clear or gate activity, as selected by the DEFAULT command.

Hardware  $\overline{\text{CLR}}$  operations and SW\_CLEAR commands return the contents of all CODE and DAC registers to their user-selected defaults. SW\_RESET commands will reset CODE and DAC register contents to their  $M/\bar{Z}$  selected initial codes. A SW\_GATE state can be used to momentarily hold selected DAC outputs in their DEFAULT positions. The contents of CODE and DAC registers can be manipulated by watchdog timer activity, enabling a variety of safety features.

## Internal Reference

The MAX5723/MAX5724/MAX5725 include an internal precision voltage reference that is software selectable to be 2.048V, 2.500V, or 4.096V. When an internal reference is selected, that voltage is available on the REF output for other external circuitry (see the [Typical Operating Circuits](#)) and can drive loads down to 25k $\Omega$ .

# MAX5723/MAX5724/ MAX5725

# Ultra-Small, Octal-Channel, 8-/10-/12-Bit Buffered Output DACs with Internal Reference and SPI Interface

## External Reference

The external reference input has a typical input impedance of 100kΩ and accepts an input voltage from +1.24V to V<sub>DD</sub>. Apply an external voltage between REF and GND to use an external reference. The MAX5723/MAX5724/MAX5725 power up and reset to external reference mode. Visit [www.maximintegrated.com/products/references](http://www.maximintegrated.com/products/references) for a list of available external voltage-reference devices.

## M/ $\bar{Z}$ Input

The MAX5723/MAX5724/MAX5725 feature a pin-selectable DAC reset state using the M/ $\bar{Z}$  input. Upon a power-on reset, all CODE and DAC data registers are reset to zero scale (M/ $\bar{Z}$  = GND) or midscale (M/ $\bar{Z}$  = V<sub>DD</sub>). M/ $\bar{Z}$  is referenced to V<sub>DD</sub> (not V<sub>DDIO</sub>). In addition, M/ $\bar{Z}$  must be valid at the time the device is powered up—connect M/ $\bar{Z}$  directly to V<sub>DD</sub> or GND.

## Load DAC ( $\overline{\text{LDAC}}$ ) Input

The MAX5723/MAX5724/MAX5725 feature an active-low asynchronous  $\overline{\text{LDAC}}$  logic input that allows DAC outputs to update simultaneously. Connect  $\overline{\text{LDAC}}$  to V<sub>DDIO</sub> or keep  $\overline{\text{LDAC}}$  high during normal operation when the device is controlled only through the serial interface. Drive  $\overline{\text{LDAC}}$  low to update the DAC outputs with data from the CODE registers. Holding  $\overline{\text{LDAC}}$  low causes the DAC registers to become transparent and CODE data is passed through to the DAC registers immediately updating the DAC outputs. A software CONFIG command can be used to configure the  $\overline{\text{LDAC}}$  operation of each DAC independently.

## Clear ( $\overline{\text{CLR}}$ ) Input

The MAX5723/MAX5724/MAX5725 feature an asynchronous active-low  $\overline{\text{CLR}}$  logic input that simultaneously sets all selected DAC outputs to their programmable DEFAULT states. Driving  $\overline{\text{CLR}}$  low clears the contents of both the CODE and DAC registers and also ignores any on-going SPI command which modifies registers associated with a DAC configured to accept clear operations. To allow a new SPI command, drive  $\overline{\text{CLR}}$  high, satisfying the t<sub>CSC</sub> timing requirement. A software CONFIG com-

mand can be used to configure the clear operation of each DAC independently.

## Watchdog Feature

The MAX5723/MAX5724/MAX5725 feature an interface watchdog timer with programmable timeout duration. This monitors the I/O interface for activity and integrity. If the watchdog is enabled, the host processor must write a valid command to the device within the timeout period to prevent a timeout. If the watchdog is allowed to timeout, selected DAC outputs are returned to the programmable DEFAULT state, protecting the system against control faults.

By default, all watchdog features are disabled; users wishing to activate any watchdog feature must configure the device accordingly. Individual DAC channels can be configured using the CONFIG command to accept the watchdog alarm and to gate, clear, or hold their outputs in response to an alarm. A watchdog refresh event and watchdog behavior upon timeout is defined by a programmable safety level using the WDOG\_CONFIG command.

## $\overline{\text{IRQ}}$ Output

The MAX5723/MAX5724/MAX5725 feature an active-low open-drain interrupt output indicating to the host when a watchdog timeout has occurred.

## Interface Power Supply (V<sub>DDIO</sub>)

The MAX5723/MAX5724/MAX5725 feature a separate supply input (V<sub>DDIO</sub>) for the digital interface (1.8V to 5.5V). Connect V<sub>DDIO</sub> to the I/O supply of the host processor.

## SPI Serial Interface

The MAX5723/MAX5724/MAX5725 4-wire serial interface is compatible with MICROWIRE, SPI, QSPI, and DSPs. The interface provides three inputs, SCLK, CSB, and DIN. The chip-select input (CSB, active-low) frames the data loaded through the serial data input (DIN). Following a CSB input high-to-low transition, the data is shifted in synchronously and latched into the input register on each falling edge of the serial clock input (SCLK). Each serial operation word is 24-bits long. The DAC data is left justified as shown in [Table 1](#). The serial

**Table 1. Format DAC Data Bit Positions**

PART	B15	B14	B13	B12	B11	B10	B9	B8	B7	B6	B5	B4	B3	B2	B1	B0
MAX5723	D7	D6	D5	D4	D3	D2	D1	D0	X	X	X	X	X	X	X	X
MAX5724	D9	D8	D7	D6	D5	D4	D3	D2	D1	D0	X	X	X	X	X	X
MAX5725	D11	D10	D9	D8	D7	D6	D5	D4	D3	D2	D1	D0	X	X	X	X

## MAX5723/MAX5724/ MAX5725

input register transfers its contents to the destination registers after loading 24 bits of data on the 24th SCLK falling edge. To initiate a new SPI operation, drive CSB high and then low to begin the next operation sequence, being sure to meet all relevant timing requirements. During CSB high periods, SCLK is ignored, allowing communication to other devices on the same bus. SPI operations consisting of more than 24 SCLK cycles are executed on the 24th SCLK falling edge, using the first three bytes of data available. SPI operations consisting of less than 24 SCLK cycles will not be executed. The content of the SPI operation consists of a command byte followed by a two-byte data word.

The DOUT phase for all SPI\_READ commands is determined by the readback command used, allowing the selection of the SCLK DOUT update edge best suited to the digital I/O implementation, maximizing data transfer speed and/or timing margin.

Guaranteed non-zero DOUT hold times allow the microprocessor to strobe DOUT on the same edge as the MAX5723/MAX5724/MAX5725 updates for fastest SPI read mode transfers. For example, if DPHA = 0 is used, the MAX5723/MAX5724/MAX5725 update DOUT in response to SCLK falling edges 8-23, while a microprocessor ( $\mu$ P) with low data hold time requirements can strobe in the DOUT data on SCLK falling edges 9-24. The device supports readback speeds of up to 25MHz for a microprocessor with 5ns data input setup requirements and allowing 35ns for  $t_{DOUT}$  at  $V_{DDIO} > 2.7V$ .

Variable DOUT phase also supports microprocessors with longer data input hold time requirements. For example, if DPHA = 1 is used, the MAX5723/MAX5724/MAX5725 updates DOUT in response to SCLK rising edges 9-24 while the microprocessor can strobe in the DOUT data on SCLK falling edges 9-24. The device supports readback speeds up to 12.5MHz for a  $\mu$ P with 5ns data input setup requirements and allowing 35ns for  $t_{DOUT}$  (assuming 50% duty cycle SCLK).

For improved readback speed while monitoring device status, the SPI\_READ\_STATUS command repeats the device status information for multiple bits, allowing polling of the device at maximum interface speeds (up to 50MHz when the readback strobe is placed away from DOUT transition edges). This transfer speed cannot be achieved for other forms of readback using the SPI\_READ\_DATA command, where more DOUT bus transitions occur.

## Ultra-Small, Octal-Channel, 8-/10-/12-Bit Buffered Output DACs with Internal Reference and SPI Interface

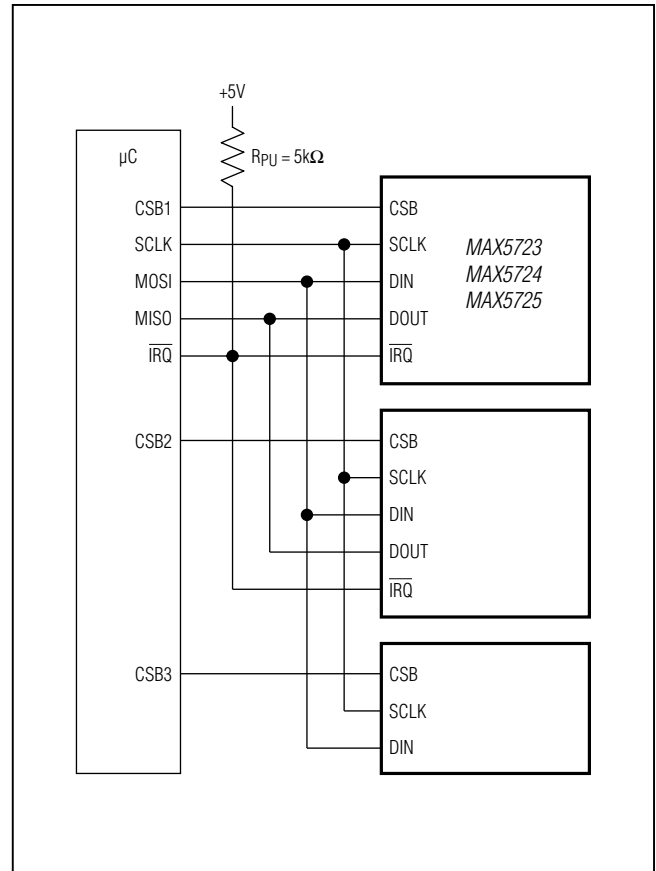

Figure 2. Typical SPI Application Circuit

Figure 1 shows the timing diagram for the complete 4-wire serial interface transmission. The DAC code settings (D) for the MAX5723/MAX5724/MAX5725 are accepted in an offset binary format (see Table 1). Otherwise, the expected data format for each command is listed in Table 2. See Figure 2 for an example of a typical SPI circuit application.

### SPI User-Command Register Map

This section lists the user-accessible commands and registers for the MAX5723/MAX5724/MAX5725.

Table 2 provides detailed information about the Command Registers.

Table 2. SPI Commands Summary

COMMAND	B23	B22	B21	B20	B19	B18	B17	B16	B15	B14	B13	B12	B11	B10	B9	B8	B7	B6	B5	B4	B3	B2	B1	B0	DESCRIPTION
CONFIGURATION AND SOFTWARE COMMANDS																									
WDOG	0	0	0	1	X	X	X	X	TIMEOUT SELECTION[11:4]								TIMEOUT SELECTION[3:0]				WD_MASK	Safety Level 00: Low 01: Med 10: High 11: Max		X	Updates watchdog settings and safety levels
REF	0	0	0	1	0	0	0	0	0	X	X	X	X	X	X	X	X	X	X	X	X	X	X	X	Seis the reference operating mode. REF Power (B18): 0 = Internal reference is only powered if at least one DAC is powered 1 = Internal reference is always powered
SW_GATE_CLR	0	0	0	1	0	0	0	0	1	0	0	1	0	1	0	0	0	0	1	1	0	0	0	0	Removes any existing GATE condition
SW_GATE_SET	0	0	0	1	0	0	0	1	1	0	1	0	1	0	1	0	0	0	1	1	0	0	0	0	Initiates a GATE condition
WD_REFRESH	0	0	0	1	0	0	1	0	1	0	1	0	1	0	1	0	0	0	1	1	0	0	0	0	Refreshes the watchdog timer
WD_RESET	0	0	0	1	0	0	1	1	1	0	1	0	1	0	1	0	0	0	1	1	0	0	0	0	Reset the watchdog time out alarm status and refreshes the watchdog timer
SW_CLEAR	0	0	0	1	0	1	0	0	1	0	1	0	1	0	1	0	0	0	1	1	0	0	0	0	Executes a software clear (all CODE and DAC registers cleared to their DEFAULT values)
SW_RESET	0	0	0	1	0	1	0	1	1	0	1	0	1	0	1	0	0	0	1	1	0	0	0	0	Executes a software reset (all CODE, DAC, and control registers returned to their power-on reset values)
CONFIG	0	0	1	0	0	0	0	0	1	0	0	1	0	1	0	0	0	0	1	1	0	0	0	0	Configures selected DAC Watchdog, GATE, LOAD, and CLEAR operations. DACs selected with a 1 in the corresponding DACn bit are updated, DACs with a 0 in the corresponding DACn bit are not impacted)

Table 2. SPI Commands Summary (continued)

COMMAND	B23	B22	B21	B20	B19	B18	B17	B16	B15	B14	B13	B12	B11	B10	B9	B8	B7	B6	B5	B4	B3	B2	B1	B0	DESCRIPTION
POWER	0	1	0	0	0	0	0	0	DAC7	DAC6	DAC5	DAC4	DAC3	DAC2	DAC1	DAC0	Power Mode 00 = Normal 01 = PD 1kΩ 10 = PD 100kΩ 11 = PD Hi-Z	X	X	X	X	X	X	X	Sets the Power Mode of the selected DACs (DACs selected with a 1 in the corresponding DACn bit are updated, DACs with a 0 in the corresponding DACn bit are not impacted)
DEFAULT	0	1	1	0	0	0	0	0	DAC7	DAC6	DAC5	DAC4	DAC3	DAC2	DAC1	DAC0	Default Values: 000: MZ 001: ZERO 010: MID 011: FULL 100: RETURN 101+: No Effect	X	X	X	X	X	X	X	Sets the DEFAULT code settings for selected DACs. Note, DACs in RETURN mode programmable RETURN codes. (DACs selected with a 1 in the corresponding DACn bit are updated, DACs with a 0 in the corresponding DACn bit are not impacted)
<b>DAC COMMANDS</b>																									
RETURNn	0	1	1	1	0	0	0	DAC Selection	RETURN REGISTER DATA[11:4]	RETURN REGISTER DATA[3:0]	X	X	X	X	X	X	X	X	X	X	X	X	X	X	Writes data to the selected RETURN register(s)
CODEn	1	0	0	0	0	0	0	DAC Selection	CODE REGISTER DATA[11:4]	CODE REGISTER DATA[3:0]	X	X	X	X	X	X	X	X	X	X	X	X	X	X	Writes data to the selected CODE register(s)
LOADn	1	0	0	1	0	0	0	DAC Selection	X	X	X	X	X	X	X	X	X	X	X	X	X	X	X	X	Transfers data from the selected CODE registers to the selected DAC register(s)
CODEn_LOAD_ALL	1	0	1	0	0	0	0	DAC Selection	CODE REGISTER DATA[11:4]	CODE REGISTER DATA[3:0]	X	X	X	X	X	X	X	X	X	X	X	X	X	X	Simultaneously writes data to the selected CODE register(s) while updating all DAC registers
CODEn_LOADn	1	0	1	1	0	0	0	DAC Selection	CODE REGISTER DATA[11:4]	CODE REGISTER DATA[3:0]	X	X	X	X	X	X	X	X	X	X	X	X	X	X	Simultaneously writes data to the selected CODE register(s) while updating selected DAC register(s)
CODE_ALL	1	1	0	0	0	0	0	0	CODE REGISTER DATA[11:4]	CODE REGISTER DATA[3:0]	X	X	X	X	X	X	X	X	X	X	X	X	X	X	Writes data to all CODE registers

Table 2. SPI Commands Summary (continued)

COMMAND	B23	B22	B21	B20	B19	B18	B17	B16	B15	B14	B13	B12	B11	B10	B9	B8	B7	B6	B5	B4	B3	B2	B1	B0	DESCRIPTION
LOAD_ALL	1	1	0	0	0	0	0	1	X	X	X	X	X	X	X	X	X	X	X	X	X	X	X	X	Updates all DAC latches with current CODE register data
CODE_ALL_LOAD_ALL	1	1	0	0	0	0	1	0	CODE REGISTER DATA[11:4]				CODE REGISTER DATA[3:0]				RETURN REGISTER DATA[3:0]				Simultaneously writes data to the all CODE registers while updating all DAC registers				
RETURN_ALL	1	1	0	0	0	0	1	1	RETURN REGISTER DATA[11:4]				RETURN REGISTER DATA[3:0]				Writes data to all RETURN registers								
SPI_DATA_REQUEST	1	1	0	1	0	0	DAC Selection	INC	DATA SEL [1:0] 00 = DAC 01 = CODE 10 = RET 11 = WDT				Setup data request for readback. INC indicates if the DAC selection is incremented to the next DAC after each SPI_READ_DATA operation DATA SEL[1:0] indicates the data content to be read back				DPHA = 0 Readback status DPHA = 1 Readback status DPHA = 0 Readback requested data DPHA = 1 Readback requested data								
SPI_READ_STATUS	1	1	1	0	0	0	0	X	X	X	X	X	X	X	X	X	X	X	X	X	X	X	X	X	DPHA = 0 Readback status DPHA = 1 Readback status
SPI_READ_DATA	1	1	1	0	1	0	0	X	X	X	X	X	X	X	X	X	X	X	X	X	X	X	X	X	DPHA = 0 Readback requested data DPHA = 1 Readback requested data
<b>NO OPERATION COMMANDS</b>																									
No Operation	1	1	0	0	0	1	X	X	X	X	X	X	X	X	X	X	X	X	X	X	X	X	X	X	These commands will have no effect on the device, but will refresh the watchdog timer if safety level is set to low.
<b>Reserved Commands:</b> Any commands not specifically listed above are reserved for Maxim internal use only.																									



### RETURNn Command

The RETURN command (B[23:20] = 0111) sets the programmable default RETURN value. This value is used for all future watchdog, clear, and gate operations when RET is selected for the DAC using the DEFAULT command. Issuing this command with DAC\_ADDRESS set to all DACs will program the value for all RETURN registers and is equivalent to RETURN\_ALL. **Note:** This command is inaccessible when a watchdog timeout has occurred if the watchdog timer is configured for safety level = high or max.

### CODEn Command

The CODEn command (B[23:20] = 1000) updates the CODE register contents for the selected DAC(s). Changes to the CODE register content based on this command will not affect DAC outputs directly unless the  $\overline{\text{LDAC}}$  input is in a low state or the DAC latch has been configured as transparent using the CONFIG command. Issuing this command with DAC\_ADDRESS set to all DACs will program the value for all CODE registers and is equivalent to CODE\_ALL.

### LOADn Command

The LOADn command (B[23:20] = 1001) updates the DAC register content for the selected DAC(s) by uploading the current contents of the selected CODE register(s) into the selected DAC register(s). Channels for which CODE content has not been modified since the last LOAD or  $\overline{\text{LDAC}}$  operation will not be updated to reduce digital crosstalk. Issuing this command with DAC\_ADDRESS set to all DACs will update the contents of all DAC registers and is equivalent to LOAD\_ALL.

### CODEn\_LOADn Command

The CODEn\_LOADn command (B[23:20] = 1011) updates the CODE register contents for the selected DAC(s) as well as the DAC register content of the selected DAC(s). Channels for which CODE content has not been modified since the last LOAD or  $\overline{\text{LDAC}}$  operation will not be updated to reduce digital crosstalk. Issuing this command with DAC\_ADDRESS set to all DACs is equivalent to the CODE\_ALL\_LOAD\_ALL (B[23:16] = 1100\_0010) command.

### CODEn\_LOAD\_ALL Command

The CODEn\_LOAD\_ALL command (B[23:20] = 1010) updates the CODE register contents for the selected DAC(s) as well as the DAC register content of all DACs. Channels for which CODE content has not been modified since the last LOAD or  $\overline{\text{LDAC}}$  operation will not be updated to reduce digital crosstalk. Issuing this command with

**Table 3. DAC Selection**

B19	B18	B17	B16	DAC SELECTED
0	0	0	0	DAC0
0	0	0	1	DAC1
0	0	1	0	DAC2
0	0	1	1	DAC3
0	1	0	0	DAC4
0	1	0	1	DAC5
0	1	1	0	DAC6
0	1	1	1	DAC7
1	X	X	X	ALL DACs

DAC\_ADDRESS set to all DACs will update the CODE and DAC register contents of all DACs and is equivalent to CODE\_ALL\_LOAD\_ALL. Note this command by definition will modify at least one CODE register; to avoid this use the LOAD command with DAC\_ADDRESS set to all DACs or the LOAD\_ALL command.

### CODE\_ALL Command

The CODE\_ALL command (B[23:16] = 1100\_0000) updates the CODE register contents for all DACs.

### LOAD\_ALL Command

The LOAD\_ALL command (B[23:16] = 1100\_0001) updates the DAC register content for all DACs by uploading the current contents of the CODE registers to the DAC registers.

### CODE\_ALL\_LOAD\_ALL Command

The CODE\_ALL\_LOAD\_ALL command (B[23:16] = 1100\_0010) updates the CODE register contents for all DACs as well as the DAC register content of all DACs.

### RETURN\_ALL Command

The RETURN\_ALL command (B[23:16] = 1100\_0011) updates the RETURN register contents for all DACs.

### NO\_OP Commands Command

All unused commands in the space (B[23:16] = 1100\_01XX or 1100\_1XXX) have no effect on the device, but will refresh the watchdog timer (if active) with the safety level set to low.

**WDOG Command**

The WDOG command (B[23:20] = 0001) updates the watchdog timeout settings and safety levels for the device. Timeout thresholds are selected in 1ms increments (1ms to 4095ms are available). The WD\_MASK bit can be used to mask the  $\overline{IRQ}$  operation in response to the watchdog status, if WD\_MASK = 1, watchdog alarms will not assert  $\overline{IRQ}$ . The watchdog alarm status (WD bit) can be polled using the available SPI status readback commands regardless of WD\_MASK settings. A write to this register will not reset a previously triggered watchdog alarm (use the WD\_RESET command for this purpose). The watchdog timer refresh and timeout behavior is defined by the programmable safety level below.

Available safety levels (WL[1:0]):

**Low (00):** Watchdog timer will refresh with the execution of any valid user mode command or no-op. Any successful slave address acknowledge qualifies to restart the watchdog timer (run to the ninth SCL edge), regardless of the command which follows. Issuing hardware  $\overline{CLR}$  or  $\overline{LDAC}$  falling edge will also refresh the watchdog timer. A triggered watchdog alarm does not prevent writes to

any register.  $\overline{LDAC}$  and  $\overline{CLR}$  inputs still function after a watchdog timeout event.

**Medium (01):** A WD\_REFRESH command must be executed in order to refresh the watchdog timer. Other commands as well as  $\overline{LDAC}$  or  $\overline{CLR}$  activity do not refresh the watchdog timer. A triggered watchdog alarm does not prevent writes to any register.  $\overline{LDAC}$  and  $\overline{CLR}$  inputs still function after a watchdog timeout event.

**High (10):** A WD\_REFRESH command must be executed to refresh the watchdog timer. Other commands as well as  $\overline{LDAC}$  or  $\overline{CLR}$  activity do not refresh the watchdog timer. A triggered watchdog alarm prevents execution of all POWER, REF, CONFIG, DEFAULT, and RETURN commands.  $\overline{LDAC}$  and  $\overline{CLR}$  inputs still function after a watchdog timeout event.

**Max (11):** A WD\_REFRESH command must be executed to refresh the watchdog timer. Other commands, as well as  $\overline{LDAC}$  or  $\overline{CLR}$  activity, do not refresh the watchdog timer. A triggered watchdog alarm prevents execution of all POWER, REF, CONFIG, DEFAULT, and RETURN commands.  $\overline{LDAC}$  and  $\overline{CLR}$  are gated and do not function after a watchdog timeout event.

**Table 4. WDOG Command Format**

B23	B22	B21	B20	B19	B18	B17	B16	B15	B14	B13	B12	B11	B10	B9	B8	B7	B6	B5	B4	B3	B2	B1	B0			
0	0	0	1	X	X	X	X	C11	C10	C9	C8	C7	C6	C5	C4	C3	C2	C1	C0	WDM	WL1	WL0	X			
WDOG Command				Don't Care				Timeout Selection								Timeout Selection				WD_MASK	WDOG Safety Level: 00: Low 01: Med 10: High 11: Max		Don't Care			
Default Value →								0	0	0	0	0	0	0	0	0	0	0	0	0	0	0	0	0	0	X
Command Byte								Data High Byte								Data Low Byte										

**Table 5. Watchdog Safety Level Protection**

WATCHDOG SAFETY LEVEL	ANY COMMAND REFRESHES WDT	$\overline{CLR}/\overline{LDAC}$ REFRESHES WDT	SW_RESET PLUS WD_RFRS REFRESHES WDT	ALL REGISTERS ACCESSIBLE AFTER WDT TIMEOUT*	$\overline{CLR}/\overline{LDAC}$ AFFECT DAC REGISTERS AFTER WDT TIMEOUT*
00 (Low)	X	X	X	X	X
01 (Med)	—	—	X	X	X
10 (High)	—	—	X	—	X
11 (Max)	—	—	X	—	—

\*Unless otherwise affected by Watchdog HOLD or  $\overline{CLR}$  configurations as set by the CONFIG command. See the CONFIG register definition for details.



**REF Command**

The REF command (B[23:20] = 0010) updates the global reference setting used for all DAC channels. If an internal reference mode is selected, bit RF2 (B18) defines the reference power mode. If RF2 is set to zero (default), the reference will be powered down any time all DAC channels are powered down (i.e. the device is in STANDBY mode). If RF2 is set to one, the reference will remain powered even if all DAC channels are powered down, allowing continued operation of external circuitry (note in this mode the low current shutdown state is not available). This command is inaccessible when a watchdog timeout has occurred and the watchdog timer is configured with a safety level of high or max.

**SW\_GATE\_CLR Command**

The SW\_GATE\_CLR command (B[23:0] = 0011\_0000\_1001\_0110\_0011\_0000) will remove any existing GATE condition initiated by a previous SW\_GATE\_SET command.

**SW\_GATE\_SET Command**

The SW\_GATE\_SET command (B[23:0] = 0011\_0001\_1001\_0110\_0011\_0000) will initiate a GATE condition. Any DACs configured with GTB = 0 (see the [CONFIG Command](#) section) will have their outputs held at the selected DEFAULT value until the GATE condition is later removed by a subsequent SW\_GATE\_CLR command. While in gate mode, the CODE and DAC registers con

tinue to function normally and are not reset (unless reset by a watchdog timeout).

**WD\_REFRESH Command**

The WD\_REFRESH command (B[23:0] = 0011\_0010\_1001\_0110\_0011\_0000) will refresh the watchdog timer. This is the only command which will refresh the watchdog timer if the device is configured with a safety level of medium, high, or max. Use this command to prevent the watchdog timer from timing out.

**WD\_RESET Command**

A WD\_RESET command (B[23:0] = 0011\_0011\_1001\_0110\_0011\_0000) will reset the watchdog interrupt (timeout) status and refresh the watchdog timer. Use this command to reset the  $\overline{TRQ}$  timeout condition after the watchdog timer has timed out. Any DACs impacted by an existing timeout condition will return to normal operation.

**SW\_CLEAR Command**

A software clear command (B[23:0] = 0011\_0100\_001\_0110\_0011\_0000) will clear the contents of the CODE and DAC registers to the DEFAULT state for all channels configured with CLB = 0 (see CONFIG command).

**SW\_RESET Command**

A software reset command (B[23:0] = 0011\_0101\_1001\_0110\_0011\_0000) will reset all CODE, DAC, and configuration registers to their defaults (including POWER, DEFAULT, CONFIG, WDOG, and REF registers), simulating a power-on reset.

**Table 6. REF Command Format**

B23	B22	B21	B20	B19	B18	B17	B16	B15	B14	B13	B12	B11	B10	B9	B8	B7	B6	B5	B4	B3	B2	B1	B0
0	0	1	0	0	RF2	RF1	RF0	X	X	X	X	X	X	X	X	X	X	X	X	X	X	X	X
REF Command				Reserved	0 = DAC Controlled 1 = Always ON	REF Mode: 00: EXT 01: 2.5V 10: 2.0V 11: 4.0V		Don't Care								Don't Care							
Default Value →					0	0	0	X	X	X	X	X	X	X	X	X	X	X	X	X	X	X	X
Command Byte								Data High Byte								Data Low Byte							

**POWER Command**

The POWER command (B[23:20] = 0100) updates the power mode settings of the selected DACs. DACs that are not selected do not update their power settings in response to the command. The new power setting is determined by bits PD[1:0] (B[7:6]) while the affected DAC(s) are selected using B[15:8]. If all DACs are powered down and the RF2 bit is not set, the device enters a STANDBY mode (all analog circuitry is disabled). This command is inaccessible when a watchdog timeout has

occurred and the watchdog timer is configured with a safety level of high or max.

Available power modes (PD[1:0]):

Normal (00): DAC channel is active (default).

PD 1kΩ (01): Power down with 1kΩ termination to GND.

PD 100kΩ (10): Power down with 100kΩ termination to GND.

PD Hi-Z (11): Power down with high-impedance output.

**Table 7. POWER Command Format**

B23	B22	B21	B20	B19	B18	B17	B16	B15	B14	B13	B12	B11	B10	B9	B8	B7	B6	B5	B4	B3	B2	B1	B0
0	1	0	0	0	0	0	0	7	6	5	4	3	2	1	0	PD1	PD0	X	X	X	X	X	X
POWER Command				Reserved				Multiple DAC Selection								Power Mode: 00 = Normal 01 = 1kΩ 10 = 100kΩ 11 = Hi-Z		Don't Care					
Default Value →								1	1	1	1	1	1	1	1	0	0	X	X	X	X	X	X
Command Byte								Data High Byte								Data Low Byte							

**CONFIG Command**

The CONFIG command (B[23:16] = 0101) updates the watchdog, gate, load, and clear mode settings of the selected DACs. DACs which are not selected do not update their settings in response to the command. The new mode settings to be written are determined by bits B[7:3] while the affected DAC(s) are selected by B[15:8]. This command is inaccessible when a watchdog timeout has occurred and the watchdog timer is configured with a safety level of high or max.

**Watchdog Configuration:**

WDOG Config settings are written by WC[1:0] (B[7:6]):

DISABLE (WC = 00): Watchdog timeout does not affect the operation of the selected DAC.

GATE (WC = 01): DAC code is gated to DEFAULT value in response to watchdog timeouts. Unless otherwise prohibited by the watchdog safety level,  $\overline{LDAC}$ ,  $\overline{CLR}$ ,

and write operations to the CODE and DAC registers are accepted but will not be reflected on the DAC output until the watchdog timeout status is reset.

$\overline{CLR}$  (WC = 10): CODE and DAC register contents are cleared to DEFAULT value in response to watchdog timeouts. All writes to CODE and DAC registers are ignored and  $\overline{LDAC}$  or  $\overline{CLR}$  input activity has no effect until the watchdog timeout status is reset, regardless of watchdog safety level.

HOLD (WC = 11): DAC code is held at its previously programmed value in response to watchdog timeout. All writes to DAC and CODE registers are ignored and  $\overline{LDAC}$  or  $\overline{CLR}$  input activity has no effect until the watchdog timeout status is reset, regardless of watchdog safety level.

**Note:** For the watchdog to timeout and have an impact, the function must first be enabled and configured using the WDOG command.

**MAX5723/MAX5724/  
MAX5725**

**Ultra-Small, Octal-Channel, 8-/10-/12-Bit  
Buffered Output DACs with Internal  
Reference and SPI Interface**

**Gate Configuration:**

The DAC GATE setting is written by GTB (B5); GATE operation is as follows:

GTB = 0: Enables software gating function (default), DAC outputs are gated to their DEFAULT settings as long as the device remains in GATE mode (set by SW\_GATE\_SET and removed by SW\_GATE\_CLR).

GTB = 1: Disable software gating function, DAC outputs are not impacted by GATE mode.

**Load Configuration:**

The LDAC\_ENB setting is written by LDB (B4); LDAC\_ENB operation is as follows:

LDB = 0: DAC latch is operational, enabling  $\overline{\text{LDAC}}$  and LOAD functions (default).

LDB = 1: DAC latch is transparent, the CODE register content controls the DAC output directly.

**Clear Configuration:**

CLEAR\_ENB setting is written by CLB (B3); CLEAR\_ENB operation is as follows:

CLB = 0: Clear input and command functions impact the DAC (default), clearing CODE and DAC registers to their DEFAULT value.

CLB = 1: Clear input and command functions have no effect on the DAC.

**Table 8. CONFIG Command Format**

B23	B22	B21	B20	B19	B18	B17	B16	B15	B14	B13	B12	B11	B10	B9	B8	B7	B6	B5	B4	B3	B2	B1	B0
0	1	0	1	0	0	0	0	7	6	5	4	3	2	1	0	WC1	WC0	GTB	LDB	CLB	X	X	X
CONFIG Command				Reserved				Multiple DAC Selection								WDOG Config: 00: DISABLE 01: GATE 10: $\overline{\text{CLR}}$ 11: HOLD		GATE_ENB	LDAC_ENB	CLEAR_ENB	Don't Care		
Default Value →								1	1	1	1	1	1	1	1	0	0	0	0	0	X	X	X
Command Byte								Data High Byte								Data Low Byte							

**DEFAULT Command**

The DEFAULT command (B[23:20] = 0110) selects the default value for selected DACs. DACs which are not selected do not update their default settings in response to the command. These default values are used for all future watchdog, clear, and gate operations. The new default setting is determined by bits DF[2:0] (B[7:5]) while the affected DAC(s) are selected using B[15:8]. This command is inaccessible when a watchdog timeout has occurred and the watchdog timer is configured with a safety level of high or max. Note the selected default values do not apply to resets initiated by SW\_RESET commands or supply cycling, both of which return all

DACs to the values determined by the M/ $\bar{Z}$  input and reset this register to M/ $\bar{Z}$  mode.

Available default values (DF[2:0]):

M/ $\bar{Z}$  (000): DAC channel defaults to value as selected by the M/ $\bar{Z}$  input (default).

ZERO (001): DAC channel defaults to zero scale.

MID (010): DAC channel defaults to midscale.

FULL (011): DAC channel defaults to full scale.

RETURN (100): DAC channel defaults to the value programmed by the RETURN command.

No Effect (101, 110, 111): DAC channel default behavior is unchanged.

**Table 9. DEFAULT Command Format**

B23	B22	B21	B20	B19	B18	B17	B16	B15	B14	B13	B12	B11	B10	B9	B8	B7	B6	B5	B4	B3	B2	B1	B0
0	1	1	0	0	0	0	0	7	6	5	4	3	2	1	0	DF2	DF1	DF0	X	X	X	X	X
DEFAULT Command				Reserved				Multiple DAC Selection								Default Values: 000: M/ $\bar{Z}$ 001: ZERO 010: MID 011: FULL 100: RETURN 101+: No Effect			Don't Care				
Default Value →								1	1	1	1	1	1	1	1	0	0	0	X	X	X	X	X
Command Byte								Data High Byte								Data Low Byte							

### SPI\_DATA\_REQUEST Command

The SPI\_DATA\_REQUEST command (B[23:20] = 1101) sets up the data request for future SPI\_READ\_DATA operations. SPI\_READ\_DATA is used to fetch the current settings of the internal CODE, DAC, or RETURN registers for each channel or the watchdog configuration (WDOG) settings or the device. The DAC address provided tells the part which channel location data is to be read back by the next SPI\_READ\_DATA command (see [Table 3](#)). Setting the DAC address greater than the number of available DACS will read back channel 0 content.

The INC bit tells the device how the next readback will update the DAC address pointer:

0 = Fix the address pointer (all further readbacks continue at the current address).

1 = Increment the address pointer (further readbacks continue at the next address, with rollover, default).

The SEL[1:0] bits tells the part what type of data is requested:

DAC (00): DAC register data (current DAC latch data, not subject to gating status, default).

CODE (01): CODE register data.

RET (10): RETURN register data.

WDT (11): WDOG register data (DAC selection does not apply).

**Table 10. SPI\_DATA\_REQUEST Command Format**

B23	B22	B21	B20	B19	B18	B17	B16	B15	B14	B13	B12	B11	B10	B9	B8	B7	B6	B5	B4	B3	B2	B1	B0	
1	1	0	1	DAC SELECTION				INC	SEL[1:0]		X	X	X	X	X	X	X	X	X	X	X	X	X	X
SPI_DATA_REQUEST				DAC Selection				Increment	Data Selection 00: DAC 01: CODE 10: RET 11: WDT		Don't Care						Don't Care							
Default Value →				0	0	0	0	1	0	0	X	X	X	X	X	X	X	X	X	X	X	X	X	
Command Byte								Data High Byte								Data Low Byte								

### SPI\_READ\_STATUS Command

The SPI\_READ\_STATUS command (B[23:18] = 111000 for DPHA = 0, B[23:18] = 111001 for DPHA = 1) reads back the watchdog timer and CLR pin status (intentionally repeated to allow maximum interface speeds) through DOUT.

DIN[18] selects the DOUT Phase (DPHA) to be used (see the SPI Serial Interface Timing Diagram in [Figure 1](#) for details).

WD\_STAT indicates a watchdog timeout condition. It reads 0 during normal operation, 1 during a timeout. WD\_STAT is not masked by the WD\_MASK bit in the WDOG\_CONFIG command.

$\overline{\text{CLR\_STAT}}$  indicates the line level of the  $\overline{\text{CLR}}$  pin. '0' indicates the  $\overline{\text{CLR}}$  input is or was asserted (grounded) during the current SPI operation. '1' indicates the  $\overline{\text{CLR}}$  input is not currently asserted ( $V_{\text{DDIO}}$  level).

**Table 11. SPI\_READ\_STATUS Command Format**

B23	B22	B21	B20	B19	B18	B17	B16	B15	B14	B13	B12	B11	B10	B9	B8	B7	B6	B5	B4	B3	B2	B1	B0
1	1	1	0	0	0	X	X	X	X	X	X	X	X	X	X	X	X	X	X	X	X	X	X
SPI_READ_STATUS (DPHA = 0)								DOUT = WD_STAT (Repeated)								DOUT = $\overline{\text{CLR\_STAT}}$ (Repeated)							
1	1	1	0	0	1	X	X	X	X	X	X	X	X	X	X	X	X	X	X	X	X	X	X
SPI_READ_STATUS (DPHA = 1)								DOUT = WD_STAT (Repeated)								DOUT = $\overline{\text{CLR\_STAT}}$ (Repeated)							
Command Byte								Data High Byte								Data Low Byte							

**SPI\_READ\_DATA Command**

The SPI\_READ\_DATA command (B[23:18] = 111010 for DPHA = 0, B[23:18] = 111011 for DPHA = 1) reads back the data requested using the SPI\_DATA\_REQUEST command through DOUT.

DIN[18] selects the DOUT phase (DPHA) to be used (see [Figure 1](#) for details, and the SPI Timing Characteristics in

the [Electrical Characteristics](#) for a complete listing of read-back speed capabilities based on the DPHA selection).

The SPI\_READ\_DATA command provides register and address data as defined by the SPI\_DATA\_REQUEST configuration SEL bits. SPI\_READ\_DATA also increments the channel address pointer if configured to do so by the SPI\_DATA\_REQUEST INC bit, the address readback is the address corresponding to the data returned.

**Table 12. SPI\_READ\_DATA Command Format**

B23	B22	B21	B20	B19	B18	B17	B16	B15	B14	B13	B12	B11	B10	B9	B8	B7	B6	B5	B4	B3	B2	B1	B0
1	1	1	0	1	0	X	X	X	X	X	X	X	X	X	X	X	X	X	X	X	X	X	X
SPI_READ_DATA (DPHA = 0, SEL = 00)								DOUT = DAC[11:4]								DOUT = DAC[3:0]				ADDRESS[3:0]			
SPI_READ_DATA (DPHA = 0, SEL = 01)								DOUT = CODE[11:4]								DOUT = CODE[3:0]				ADDRESS[3:0]			
SPI_READ_DATA (DPHA = 0, SEL = 10)								DOUT = RETURN[11:4]								DOUT = RET[3:0]				ADDRESS[3:0]			
SPI_READ_DATA (DPHA = 0, SEL = 11)								DOUT = WDOG[15:8]								DOUT = WDOG[7:1]							0
1	1	1	0	1	1	X	X	X	X	X	X	X	X	X	X	X	X	X	X	X	X	X	X
SPI_READ_DATA (DPHA = 1, SEL = 00)								DOUT = DAC[11:4]								DOUT = DAC[3:0]				ADDRESS[3:0]			
SPI_READ_DATA (DPHA = 1, SEL = 01)								DOUT = CODE[11:4]								DOUT = CODE[3:0]				ADDRESS[3:0]			
SPI_READ_DATA (DPHA = 1, SEL = 10)								DOUT = RETURN[11:4]								DOUT = RET[3:0]				ADDRESS[3:0]			
SPI_READ_DATA (DPHA = 1, SEL = 11)								DOUT = WDOG[15:8]								DOUT = WDOG[7:1]							0
Command Byte								Data High Byte								Data Low Byte							

## Applications Information

### Power-On Reset (POR)

When power is applied to  $V_{DD}$  and  $V_{DDIO}$ , the DAC output is set to zero scale. To optimize DAC linearity, wait until the supplies have settled and the internal setup and calibration sequence completes (200 $\mu$ s, typ).

### Power Supplies and Bypassing Considerations

Bypass  $V_{DD}$  and  $V_{DDIO}$  with high-quality ceramic capacitors to a low-impedance ground as close as possible to the device. Minimize lead lengths to reduce lead inductance. Connect the GND to the analog ground plane.

### Layout Considerations

Digital and AC transient signals on GND can create noise at the output. Connect GND to form the star ground for the DAC system. Refer remote DAC loads to this system ground for the best possible performance. Use proper grounding techniques, such as a multilayer board with a low-inductance ground plane, or star connect all ground return paths back to the MAX5723/MAX5724/MAX5725 GND. Carefully layout the traces between channels to reduce AC cross-coupling. Do not use wire-wrapped boards and sockets. Use shielding to minimize noise immunity. Do not run analog and digital signals parallel to one another, especially clock signals. Avoid routing digital lines underneath the MAX5723/MAX5724/MAX5725 package.

## Definitions

### Integral Nonlinearity (INL)

INL is the deviation of the measured transfer function from a straight line drawn between two codes once offset and gain errors have been nullified.

### Differential Nonlinearity (DNL)

DNL is the difference between an actual step height and the ideal value of 1 LSB. If the magnitude of the DNL  $\leq$  1 LSB, the DAC guarantees no missing codes and is monotonic. If the magnitude of the DNL  $\geq$  1 LSB, the DAC output may still be monotonic.

### Offset Error

Offset error indicates how well the actual transfer function matches the ideal transfer function. The offset error is calculated from two measurements near zero code and near maximum code.

### Gain Error

Gain error is the difference between the ideal and the actual full-scale output voltage on the transfer curve, after nullifying the offset error. This error alters the slope of the transfer function and corresponds to the same percentage error in each step.

### Zero-Scale Error

Zero-scale error is the difference between the DAC output voltage when set to code zero and ground. This includes offset and other die level nonidealities.

### Full-Scale Error

Full-scale error is the difference between the DAC output voltage when set to full scale and the reference voltage. This includes offset, gain error, and other die level nonidealities.

### Settling Time

The settling time is the amount of time required from the start of a transition, until the DAC output settles to the new output value within the converter's specified accuracy.

### Digital Feedthrough

Digital feedthrough is the amount of noise that appears on the DAC output when the DAC digital control lines are toggled.

### Digital-to-Analog Glitch Impulse

A major carry transition occurs at the midscale point where the MSB changes from low to high and all other bits change from high to low, or where the MSB changes from high to low and all other bits change from low to high. The duration of the magnitude of the switching glitch during a major carry transition is referred to as the digital-to-analog glitch impulse. Although all bits change, larger steps may lead to larger glitch energy.

The digital-to-analog power-up glitch is the duration of the magnitude of the switching glitch that occurs as the device exits power-down mode.

Detailed Functional Diagram

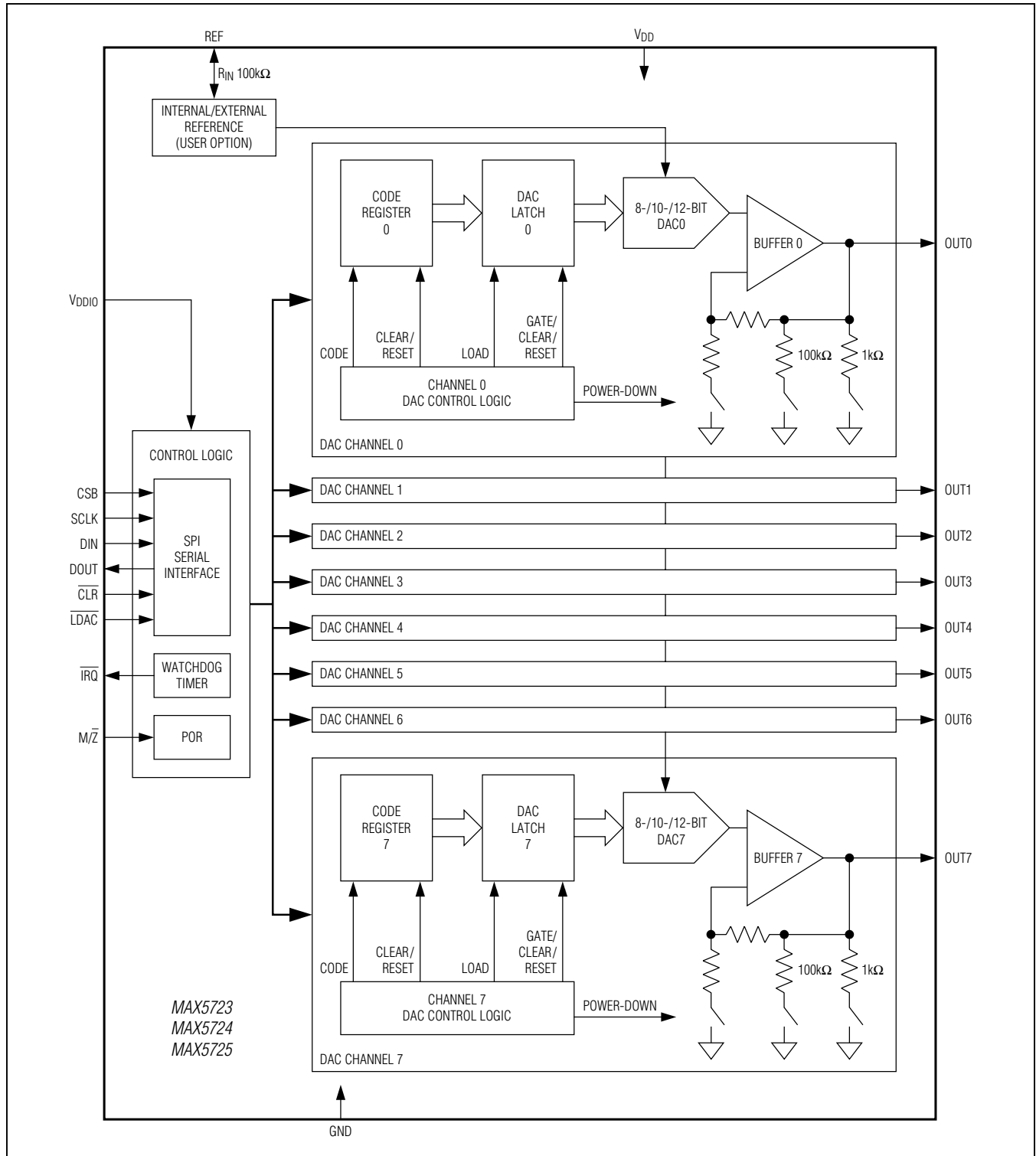



Typical Operating Circuits

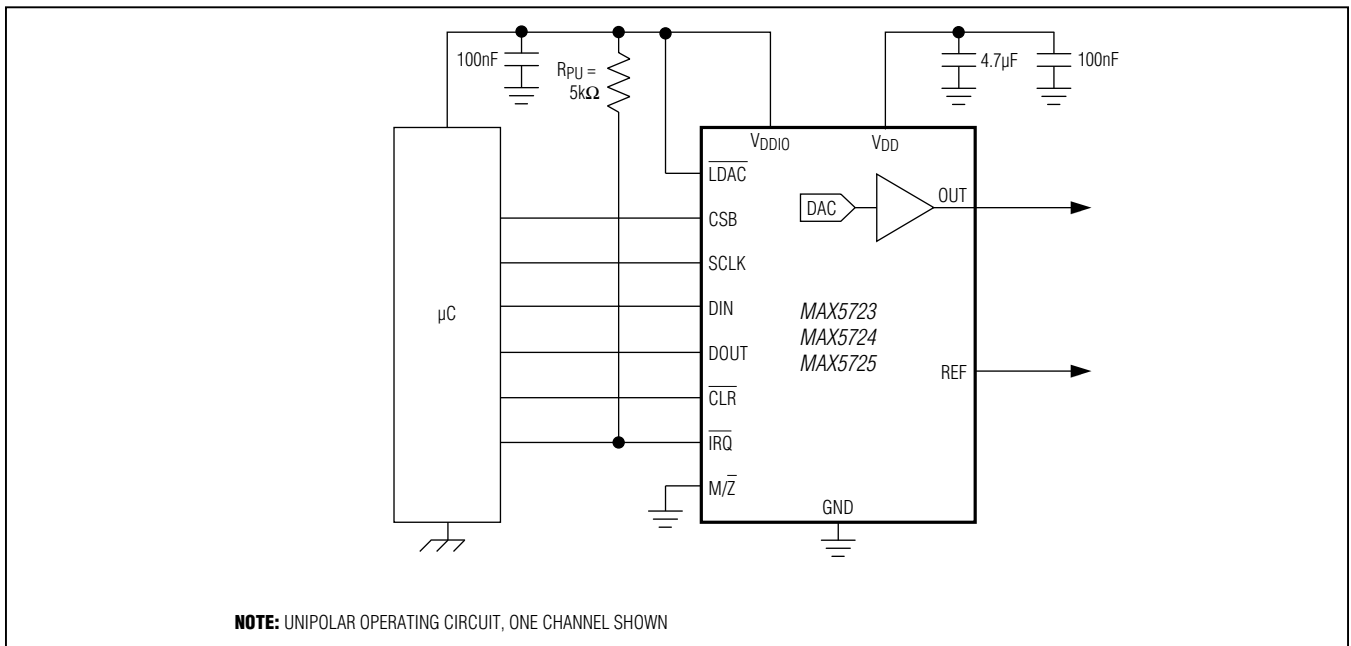
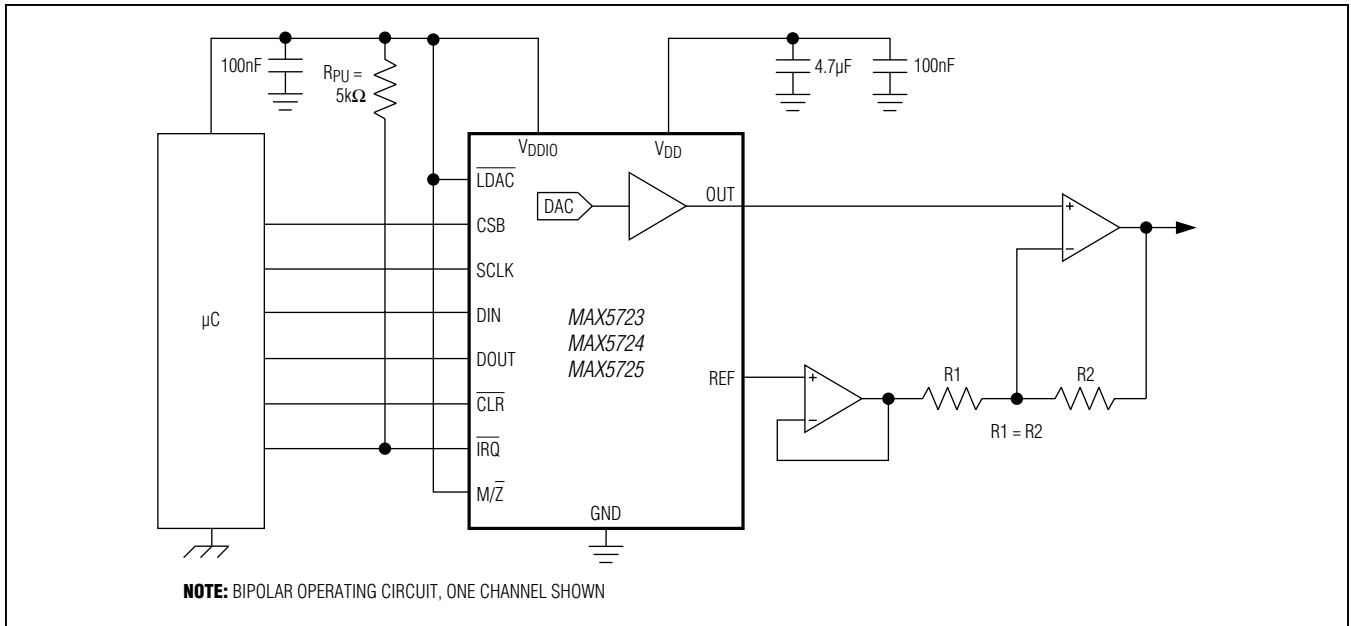

MAX5723/MAX5724/  
MAX5725

Ultra-Small, Octal-Channel, 8-/10-/12-Bit  
Buffered Output DACs with Internal  
Reference and SPI Interface

Ordering Information

PART	TEMP RANGE	PIN-PACKAGE	RESOLUTION (BIT)
MAX5723AUP+	-40°C to +125°C	20 TSSOP	8
MAX5724AUP+	-40°C to +125°C	20 TSSOP	10
MAX5725AAUP+	-40°C to +125°C	20 TSSOP	12
MAX5725AWP+T	-40°C to +125°C	20 WLP	12
MAX5725BAUP+	-40°C to +125°C	20 TSSOP	12

**Note:** All devices are specified over the -40°C to +125°C temperature range.  
+Denotes a lead(Pb)-free/RoHS-compliant package.  
T = Tape and reel.

Chip Information

PROCESS: BiCMOS

Package Information

For the latest package outline information and land patterns (footprints), go to [www.maximintegrated.com/packages](http://www.maximintegrated.com/packages). Note that a "+", "#", or "-" in the package code indicates RoHS status only. Package drawings may show a different suffix character, but the drawing pertains to the package regardless of RoHS status.

PACKAGE TYPE	PACKAGE CODE	OUTLINE NO.	LAND PATTERN NO.
20 TSSOP	U20+1	<a href="#">21-0066</a>	<a href="#">90-0116</a>
20 WLP	W202C2+1	<a href="#">21-0059</a>	Refer to <a href="#">Application Note 1891</a>

## Revision History

REVISION NUMBER	REVISION DATE	DESCRIPTION	PAGES CHANGED
0	3/12	Initial release	—
1	11/12	Revised the <i>Ordering Information</i> , <i>Electrical Characteristics</i> , <i>Typical Operating Characteristics</i> , <i>Pin Configuration</i> , <i>Pin Description</i> , Figure 1, and the <i>DAC Outputs (OUT_)</i> , <i>CODEn_LOADn Command</i> , and <i>Offset Error</i> sections	3, 5, 8, 10–13, 15–18, 23, 31, 34
2	2/13	Released the MAX5723/MAX5724/MAX5725B, and updated the <i>Electrical Characteristics</i> global and Note 3	2–8, 34

Maxim Integrated cannot assume responsibility for use of any circuitry other than circuitry entirely embodied in a Maxim Integrated product. No circuit patent licenses are implied. Maxim Integrated reserves the right to change the circuitry and specifications without notice at any time. The parametric values (min and max limits) shown in the *Electrical Characteristics* table are guaranteed. Other parametric values quoted in this data sheet are provided for guidance.

# Mouser Electronics

Authorized Distributor

Click to View Pricing, Inventory, Delivery & Lifecycle Information:

[Analog Devices Inc.:](#)

[MAX5725BAUP+T](#) [MAX5725BAUP+](#)

Other:

[MAX5725AWP+T](#)