

1-770969-1 ✓ ACTIVE

MATE-N-LOK | Mini-Universal MATE-N-LOK

TE Internal #: 1-770969-1

Rectangular Power Connectors, Header, Plug, Wire-to-Board, 6 Position, 4.14 mm [.162 in] Centerline, Printed Circuit Board, Mini-Universal MATE-N-LOK

[View on TE.com >](#)



Connectors > Power Connectors > Rectangular Power > Rectangular Power Connectors



Rectangular Power Connector Type: **Header**

Connector & Housing Type: **Plug**

Connector System: **Wire-to-Board**

Number of Positions: **6**

Centerline (Pitch): **4.14 mm [.162 in]**

Features

Product Type Features

Header Type	Fully Shrouded
Rectangular Power Connector Type	Header
Connector & Housing Type	Plug
Connector System	Wire-to-Board
Sealable	No
Connector & Contact Terminates To	Printed Circuit Board

Configuration Features

Number of Positions	6
PCB Mount Orientation	Right Angle
Number of Power Positions	6
Number of Signal Positions	0
Number of Rows	2

Electrical Characteristics

Operating Voltage	600 VDC
-------------------	---------



Contact Features

Multiple Contact Types	Without
PCB Contact Termination Area Plating Material Thickness	3.81 μm [150 μin]
Contact Mating Area Plating Material	Gold
Contact Current Rating (Max)	9.5 A
Contact Retention Within Housing	Without
Contact Type	Pin
PCB Contact Termination Area Plating Material	Tin-Lead
Contact Mating Area Plating Material Thickness	.76 μm [30 μin]

Termination Features

Termination Post & Tail Length	3.69 mm[.145 in]
Termination Method to Printed Circuit Board	Through Hole - Solder

Mechanical Attachment

Strain Relief	Without
Mating Alignment Type	Chamfered Edges
Mating Retention	With
Mating Alignment	With
PCB Mount Alignment	Without
Panel Mount Feature	Without
PCB Mount Retention	With
PCB Mount Retention Type	Boardlock
Mating Retention Type	Locking Tab
Connector Mounting Type	Board Mount

Housing Features

Centerline (Pitch)	4.14 mm[.162 in]
Housing Color	White
Housing Material	Nylon

Dimensions

Connector Height	11.86 mm
PCB Thickness (Recommended)	.06 mm[1.57 in]
Product Width	12.7 mm
Product Length	14 mm



Row-to-Row Spacing	4.14 mm [.163 in]
--------------------	-------------------

Usage Conditions

Operating Temperature Range	-55 – 105 °C [-67 – 221 °F]
-----------------------------	-----------------------------

Operation/Application

Circuit Application	Power
---------------------	-------

Industry Standards

CSA Rating	Certified, LR 7189
------------	--------------------

UL Rating	Recognized
-----------	------------

Agency/Standard	CSA, UL
-----------------	---------

Approved Standards	UL E28476
--------------------	-----------

UL Flammability Rating	UL 94V-0
------------------------	----------

Glow Wire Rating	Standard Part - Not Glow Wire
------------------	-------------------------------

Packaging Features

Packaging Quantity	100
--------------------	-----

Packaging Method	Bag
------------------	-----

Product Compliance

[For compliance documentation, visit the product page on TE.com>](#)

EU RoHS Directive 2011/65/EU	Compliant
------------------------------	-----------

EU ELV Directive 2000/53/EC	Compliant
-----------------------------	-----------

China RoHS 2 Directive MIIT Order No 32, 2016	No Restricted Materials Above Threshold
---	---

EU REACH Regulation (EC) No. 1907/2006	Current ECHA Candidate List: JAN 2023 (233) Candidate List Declared Against: JAN 2023 (233) Does not contain REACH SVHC
--	---

Halogen Content	Low Halogen - Br, Cl, F, I < 900 ppm per homogenous material. Also BFR/CFR/PVC Free
-----------------	---

Solder Process Capability	Wave solder capable to 265°C
---------------------------	------------------------------

Product Compliance Disclaimer

This information is provided based on reasonable inquiry of our suppliers and represents our current actual knowledge based on the information they provided. This information is subject to change. The part numbers that TE has identified as EU RoHS compliant have a maximum concentration of 0.1% by weight in homogenous materials for lead, hexavalent chromium, mercury, PBB, PBDE, DBP, BBP, DEHP, DIBP, and 0.01% for cadmium, or qualify for an exemption to these limits as defined in the Annexes of Directive 2011/65/EU (RoHS2). Finished electrical and electronic equipment products will be CE marked as required by Directive 2011/65/EU. Components may not be CE marked. Additionally, the part

numbers that TE has identified as EU ELV compliant have a maximum concentration of 0.1% by weight in homogenous materials for lead, hexavalent chromium, and mercury, and 0.01% for cadmium, or qualify for an exemption to these limits as defined in the Annexes of Directive 2000/53/EC (ELV). Regarding the REACH Regulation, the information TE provides on SVHC in articles for this part number is based on the latest European Chemicals Agency (ECHA) 'Guidance on requirements for substances in articles' posted at this URL: <https://echa.europa.eu/guidance-documents/guidance-on-reach>

Compatible Parts



TE Part # 794772-6
06P MINI UMNL SEAL, DIE CUT



TE Part # 794190-1
06P MINI UMNL2 PLUG HSG UL94V0



TE Part # 172168-1
6 CIR UNIV M-N-L PLUG



TE Part # 794895-1
6 CIR MINI UMNL RND WIRE HOLES

Also in the Series | Mini-Universal MATE-N-LOK



Connector Contacts(9)



Insertion & Extraction Tools(1)



PCB Headers & Receptacles(1)



Power Contacts(84)



Rectangular Backshells & Clamps(2)



Rectangular Boots & Strain Relief(2)



Rectangular Connector Keying Plugs(2)



Rectangular Connector Locking(2)



Rectangular Connector Seals(17)



Rectangular Power Connectors(243)

Customers Also Bought



TE Part #1-770974-1
16P MINI UMNL R/A HDR ASSY LF



TE Part #1888652-1
2X1 OFFSET STACK JACK



TE Part #2-1445100-4
MICRO MNL HDR ASSY S/ROW LF

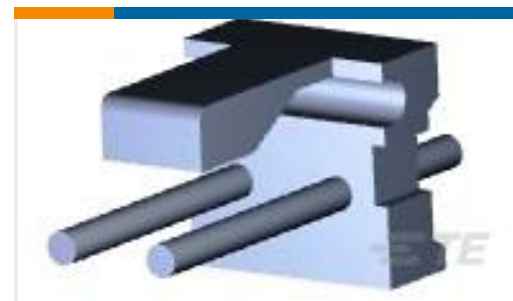

TE Part #3-641120-2
02P MTA156 HDR ASSY FL/ST LF



TE Part #643406-1
05P UMNL PIN HDR ASSY POL 94VO



TE Part #1735284-2
SATA BACKPLANE RECEPTACLE,
VERTICAL, SMT

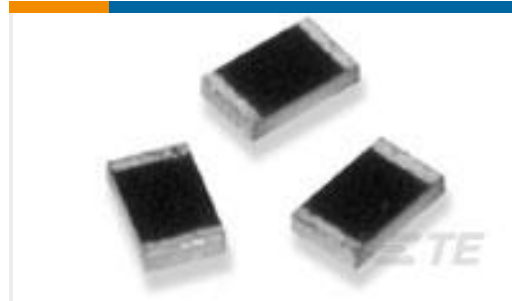

TE Part #8-1879253-2
RP 2B 20R 0.1% 15PPM CUT LENGTH



TE Part #2842102-5
5P,2MM,BRK HDR,SRVT,SMD,0.1AU,
TR W/CAP



TE Part #2176509-1
CJP 400W 1R5 5% Lead

Documents

Product Drawings

06P MINI UMNL R/A HDR ASSY LF

English

CAD Files

3D PDF

3D

Customer View Model

[ENG_CVM_CVM_1-770969-1_E.2d_dxf.zip](#)

English

Customer View Model

[ENG_CVM_CVM_1-770969-1_E.3d_igs.zip](#)

English

Customer View Model

[ENG_CVM_CVM_1-770969-1_E.3d_stp.zip](#)

English

By downloading the CAD file I accept and agree to the [Terms and Conditions](#) of use.

Datasheets & Catalog Pages



[SOFT_SHELL_PIN_AND_SOCKET_CONNECTORS_CATALOG](#)

English

[Product Specifications](#)

[Application Specification](#)

English

[Product Environmental Compliance](#)

[MD_1-770969-1_022520192356_dmtec](#)

English

[MD_1-770969-1_022520192356_dmtec](#)

English

[Instruction Sheets](#)

[Instruction Sheet \(U.S.\)](#)

English

[Agency Approvals](#)

[UL](#)

English