

### DESCRIPTION

The PQC250 series switching power supplies utilize advanced component and circuit technologies to deliver high efficiency and low power dissipation, in both operational and standby operation, in a compact **3.0" x 5.0" x 1.40"** package. Designed for industrial, medical, computing, communications, telecom, consumer, and other OEM applications, and deployable in 1U customer enclosures. All models offer universal AC input capability with active power factor correction (PFC) and compliance to worldwide safety and EMC standards.

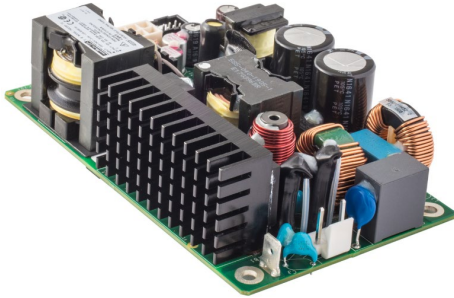

### FEATURES

- Industry leading MTBF
- Certified to IEC 60601 Ed.3 medical (2 x MOPP Pri-Sec; 1 x MOPP Pri-Chassis Ground), AC input models.
- IEC 60950-1 compliant
- IEC 60335-1 Certificate
- Designed to comply with IEC60601-1-2 4<sup>th</sup> Edition EMC Standard Requirements<sup>1</sup>
- 250W Convection, 100Vac to 264Vac +50C operation
- Very low no load standby power; designed to meet ENERGY STAR<sup>®</sup> Program Requirements for Single Voltage External AC-DC Power Supplies
- True zero load operation of the Main (V1) output; no minimum load requirements
- Constant Current overload protection option<sup>3</sup>
- 3" x 5" industry standard footprint
- Optional DC input capability
- High efficiency 94% typical
- Remote sense, main output
- Universal AC input with active PFC
- Less than 1U high
- RoHS compliant
- Active inrush protection
- Compatibility with MVAC250 Series products<sup>2</sup>
- Droop current share, output Terminal block option
- Two-year warranty

<sup>1</sup> When deployed in the End User equipment  
<sup>2</sup> Fan output of MVAC250 series not available on this product series  
<sup>3</sup> Select voltage variants



Available now at <http://www.murata-ps.com/en/3d/acdc.html>

### ORDERING GUIDE (BASIC MODEL NUMBER)

Model Number <sup>3</sup>	Main output (V1)			Aux Output (V2)		Max. Load Capacitance Main output <sup>4</sup>
	Voltage Vdc	Current @ 50°C 250W	Current @ 70°C <sup>1</sup> 200W	Vdc	Current 50°C & 70°C	
PQC250-12yyy	12	20.8A	16.7A	5	0.5A	6000µF
PQC250-18yyy	18	13.8A	11.1A			1,600µF
PQC250-24yyy	24	10.4A	8.3A			1200µF
PQC250-28yyy	28	8.93A	7.1A			1200µF
PQC250-30yyy	30	8.33A	6.6A			1000µF
PQC250-36yyy	36	6.9A	5.6A			1000µF
PQC250-48yyy (PoE Compliant)	48	5.2A	4.2A			750µF
PQC250-54yyy (PoE Compliant)	54	4.6A	3.7A			500µF

PQC-COVER Optional cover kit assembly see [PQC-COVER](#) datasheet for details

<sup>1</sup> Output De-Rating at 70°C is for horizontal orientation with component side up only. Please refer to [ACAN-77](#) for details  
<sup>2</sup> 29V model available, consult with factory for more information  
<sup>3</sup> See Part Number Structure for "yyy" options refer to: [Part Number Options Guide](#)  
<sup>4</sup> Max capacitance limit does not apply to constant current "C" option

### INPUT CHARACTERISTICS

Parameter	Conditions	Min	Nom	Max	Units
Input Voltage AC Operating Range	Single Phase	90	100/240	264	Vac
Input Frequency		47	50/60	63	Hz
Turn-on input voltage	Input rising	75		90	Vac
Turn-off input voltage	Input falling	65		80	Vac
DC input <sup>1, 2</sup>		127		300	
		260		400	
Maximum input current	Vin = 115V <sub>AC</sub> ; Full Load		2.5		Arms
	<sup>2</sup> Vin = 127-300Vdc			2.7	Adc
	<sup>2</sup> Vin = 260-400Vdc			1.5	Adc
Inrush Current	230V <sub>AC</sub> , Cold start, 25°C;		30		Apk
Power Factor	At 115VAC, full load	0.95			W/VA
Hold-up Time	90V <sub>AC</sub> ; Full Load	16			msec
Efficiency @ 230V <sub>AC</sub> for PQC250-48 model.	20% Full Load		88.5		%
	50% Full Load		94		
	100% Full Load		95		
No Load Input Power Consumption	(PS_ON = OFF; Aux (V2) = 0A)			<0.5	W

<sup>1</sup> 260-400Vdc range applies to PQC250-xxH variants only; consult with the sales channel for details and availability.  
<sup>2</sup> Medical certification applies only to AC input models.

### OUTPUT CHARACTERISTICS

Parameter	Conditions	Min	Nom	Max	Units
Line, Load Regulation	Main (V1) Output <sup>1</sup>			±1	%
	Aux (V2) Output			±5	
Minimum Load Capability	Stable Operation	0			A
Output Ripple	Zero to Full Load <sup>2</sup>			1	%

<sup>1</sup> Zero load output voltage may exceed the regulation window however will not cause OVP to engage or PWRONK to change to low state.  
A 500mA min. load current is required to keep output voltage within ±1%.

<sup>2</sup> Ripple and noise are measured with 0.1µF ceramic capacitor and 10µF tantalum capacitor. A short coaxial cable with 50 ohm termination is used.

### AUXILIARY OUTPUT CHARACTERISTICS (ALL MODELS)

Auxiliary Output	Aux Output Voltage	Load Current	Load Capacitance	Line, Load, Cross Regulation	Ripple Voltage & Noise
Aux (V2)	5V	0 to 0.5A	0 to 220µF	± 5%	120mVPP



For full details go to [www.murata-ps.com/rohs](http://www.murata-ps.com/rohs)



Applies to AC Input models

### MAIN OUTPUT CHARACTERISTICS (ALL MODELS EXCEPT WHERE NOTED)

Parameter	Conditions	Typ.	Max.	Units
Transient Response <sup>1</sup>	50% load step, 1A/μsec slew rate and min 0.1A load		± 5	%
Settling Time to 1% of Nominal			500	μsec
Turn On Delay	After application of input power		3	sec
Output Voltage Rise	Monotonic		50	msec
Remote Sense	Compensates for up to 120mV of total lead drop (output and return connections) with remote sense connected. Protected against short circuit and reverse connection.		120	mV

<sup>1</sup> Min. 1 second time between consecutive transients.

### ENVIRONMENTAL CHARACTERISTICS

Parameter	Conditions	Min.	Typ.	Max.	Units
Storage Temperature Range		-40		85	°C
Operating Temperature Range	See power <a href="#">derating curves</a>	-10		70	
	Start up with -20C @ 100V <sub>AC</sub> minimum input *contact Murata for lower operating temperature range	-20		-	
Operating Humidity	Non-condensing	10		95	%
Operating Altitude		-200		5000 <sup>1</sup>	m
MTBF	Telcordia SR-332 Issue 3; M1C3 @ 40°C Telcordia SR-332 Issue 3; M1C3 @ 25°C		2,145K 4,500K		Hours
Shock	30G, non-operating	Complies			
Operational Vibration	Sine Sweep; 5-150Hz, 2G Random Vibration, 5-500Hz, 1.11G	Complies			
Safety – Medical Standards 2 x MOPP (Primary-Secondary)	IEC 60601 1:2005, IEC 60601 1:2005/AMD1:2012 ANSI/AAMI ES60601-1: A1:2012, C1:2009/(R)2012 and A2:2010/(R)2012, CSA CAN/CSA-C22.2 NO. 60601-1:14 EN 60601-1:2006/A1:2013				
Safety – ITE & Consumer Standards	IEC 60950-1:2005, IEC 60950-1:2005/AMD1:2009, IEC 60950-1:2005/AMD2:2013 CAN/CSA-C22.2 No. 60950-1-07, Amendment 2:2014 (MOD) ANSI/UL 60950-1-2014 EN 60950-1:2006+A11+A1+A12+A2 IEC 60335-1:2010, IEC 60335-1:2010 /AMD1:2013 IEC 62368-1:2014 CAN/CSA-C22.2 No. 62368-1:14 UL 62368-1 2nd Ed GB17625.1-2012, GB4943.1-2011, GB/T9254-2008 (Class A) CNS13438 95; CNS14336-1 99; CNS 15663 5 102 (For model PQC250-12 only)				
Fuses	Dual Fuses; Line and Neutral; 6.3A Time Lag; 250V				
Outside Dimensions	3.0" x 5.0" x 1.44" (76.2mm x 127mm x 35.2mm) nominal				
Weight (typ.)	0.352/0.78				kg/lbs.

<sup>1</sup> 3000 M max. altitude for Medical applications

### PROTECTION CHARACTERISTICS

Parameter	Conditions	Min.	Typ.	Max.	Units
Over Voltage Protection	V1 (main output) latching	115		140	%
	V2 (aux output) latching	5.5		7.5	V
Over Current Protection <sup>1</sup>	V1, hiccup mode	120		150	%A <sub>max</sub>
	V1, latch mode	160		Short circuit	
	V2, auto-recovery	110		150	
<a href="#">Over Temperature Protection</a> (Primary and Secondary Heatsink Temperature)	Auto-recovery	125		130	°C
Remote Sense Short Circuit Protection			Complies		
Remote Sense Reverse Connection Protection			Complies		

<sup>1</sup> Overcurrent conditions below 150% result in hiccup. Above 160% will cause the supply to latch off. Also, refer to Constant Current overload section on page 5

<sup>2</sup> In the event of a fault overvoltage or overcurrent fault that causes a "latch" state; it shall be necessary to recycle the incoming AC source. Allow the AC source to be removed for a period of not less than 10s before reapplying.

### ISOLATION CHARACTERISTICS

Parameter	Conditions	Min.	Typ.	Max.	Units
Isolation	Primary to Chassis	1500			V <sub>AC</sub>
	Primary to Secondary (2xMOPP)	4000			
	Secondary to Chassis <sup>1</sup>	1500			
	Output to Output				
	Secondary to chassis <sup>2</sup>	100			V <sub>DC</sub>
Earth Leakage Current (under single fault condition)	264V <sub>AC</sub> , 60Hz, 25°C		300		μA
Earth Leakage Current (under normal conditions)	264V <sub>AC</sub> , 60Hz, 25°C		150		μA

<sup>1</sup> For PQC250-48-yyy and PQC250-54-yyy variants only.

<sup>2</sup> For all other variants

### CURRENT SHARING OPTION – PQC250-XX-DXX

Model Number	Description
PQC250-XX-Dxx Refer to <a href="#">ACAN-78</a> for additional details	<p>Main Output current share is achieved using “the droop method”. Nominal output voltage is achieved at 50% load and output voltage increases/decreases approximately ±3% of nominal voltage. This regulation window does not include the additional tolerance due to line, temperature, long term stability etc.</p> <p>Startup of parallel power supplies is not internally synchronized. If more than 250W combined power is needed, start-up synchronization must be provided by system using a common PS_ON signal. To account for ±10% full load current sharing accuracy and the reduction in full load output voltage due to droop, available output power must be derated by 15% when units are operated in parallel. Current sharing can be achieved with or without remote sense connected to the common load.</p> <p>ORing protection is available on the PQC250-xxDRT models (see Application notes, <a href="#">ACAN-78</a> for additional details); Aux (V2) output can be tied together for redundancy but total combined output power must not exceed 2.5W, external ORing devices are recommended to preserve redundancy.</p>

### EMISSIONS AND IMMUNITY<sup>1</sup>

Characteristic	Standard	Compliance
Input Current Harmonics	IEC/EN 61000-3-2	Class A
Voltage Fluctuation and Flicker	IEC/EN 61000-3-3	Complies
Conducted Emissions	EN 55032	Class B
	FCC Part 15	Class B
Radiated Emissions	CISPR 22 -3 meter	Class B
	FCC 15.109 - 3 meter	Class B
ESD Immunity	IEC/EN 61000-4-2	Level 4, Criterion 2
Radiated Field Immunity	IEC/EN 61000-4-3	Level 3, Criterion A
Electrical Fast Transient Immunity	IEC/EN 61000-4-4	Level 4, Criterion A
Surge Immunity	IEC/EN 61000-4-5	Level 3, Criterion A (Com. Mode: 2kV 12 OHM, Diff. Mode: 1kV, 2 OHM)
Radiated Field Conducted Immunity	IEC/EN 61000-4-6	Level 3, 10V/m, Criterion A
Magnetic Field Immunity	IEC/EN 61000-4-8	Level 3, Criterion A
Voltage dips, interruptions <sup>2</sup>	IEC/EN 61000-4-11	Level 3, Criterion B

<sup>1</sup> Designed to comply with IEC60601-1-2 4<sup>th</sup> Edition EMC Standard Requirements

<sup>2</sup> For AC source interruptions that extend beyond 20ms then the output it shall be necessary to recycle the incoming AC source. Allow the AC source to be removed for a period of not less than 10s before reapplying.

### EMI CONSIDERATIONS

For optimum EMI performance, the power supply should be mounted to a metal plate grounded to all 4 mounting holes of the power supply. To comply with safety standards, this plate must be properly grounded to protective earth (see mechanical dimension notes). Pre-compliance testing has shown the stand-alone power supply to comply with EN55022 class B radiated emissions with a metal enclosure with grounded base plate. See PQC-COVER for details - testing was based on adding a toroid, Fair-Rite#5961004901 with five turns of both of the output leads. Radiated emission results vary with system enclosure and cable routing paths.

### STATUS AND CONTROL SIGNALS

Parameter	Models	Conditions
PS_ON Connector J3 Pin 4	All Models (Except as noted)	This pin must be pulled low (sink current >2mA) to +5V_AUX_RTN (connector J3 Pin 8) to (enable) turn on the main output. The +5V_AUX output is independent of the PS_ON signal, and comes up automatically when the input AC or input DC voltage is applied within their specified operating ranges.
	“C” Option Models	This pin can be left unterminated (or alternatively pulled high to +5V_AUX; Connector J3 Pin 1) to (enable) turn on the main output. The +5V_AUX output is independent of the PS_ON signal, and comes up automatically when the input AC or input DC voltage is applied (within their respective specified operating ranges). If it is desired to turn off the Main Output (during normal operation) then this pin can be pulled “low” (sink current >2mA) to +5V_AUX_RTN.
PWR_OK Connector J3 Pin 2	All Models	Open collector logic goes high 40-100ms after the main output is within regulation; it goes low at least 2msecs before loss of regulation. Internal 10K pull up to +5V_AUX is provided. Applications using the PWR_OK signal should maintain a minimum load of 5W on the main output.

### PART NUMBER STRUCTURE

Part Number Structure	Options
PQC 250 - xx yyy	<p><b>Options<sup>4</sup></b></p> <p>D<sup>1</sup> = Droop</p> <p>DRT = ORing; Droop; Output Terminal Block</p> <p>H = Full range HVDC input<sup>2</sup> Link back to <a href="#">Input Table</a></p> <p>C<sup>3</sup> = Constant Current Output Overload Protection</p>
PQC = “Power, Quality, Convection Cooled”	
	<p><b>Main Output Voltage</b> (12, 18, 24, 28, 30, 36, 48, 54)</p> <p><b>Output Power (Watts)</b></p>

**Examples:** PQC250-24 = Base 24V Model; no options

PQC250-24D = Base model, 24V Model with Droop Current Share option

PQC250-24DRT = Base model, 24V Model with Droop Current Share, ORing isolation and Terminal Block options

PQC250-24CRT = Base inclusive of Constant Current Output Overload Protection characteristic plus ORing plus Terminal Block (no droop)

<sup>1</sup> Not available for 18V model

<sup>2</sup> CCC Certification not included for “H” models and 30V models;

<sup>3</sup> Only available for 24V and 28V Voltage Variants

<sup>4</sup> “yyy” can be any combination of the options as shown or left blank; “C” and “D” options not possible in combination.

PERFORMANCE TYPICAL DATA EXAMPLES

Efficiency 48V Model

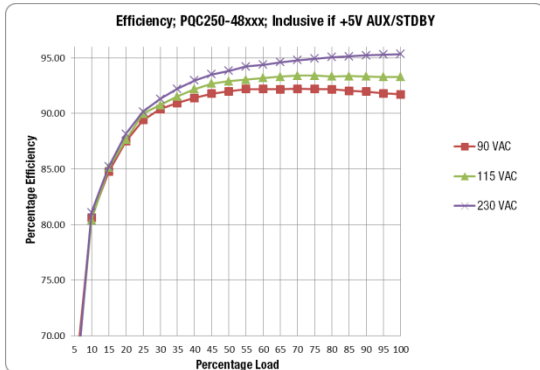

Ripple, 12V Model

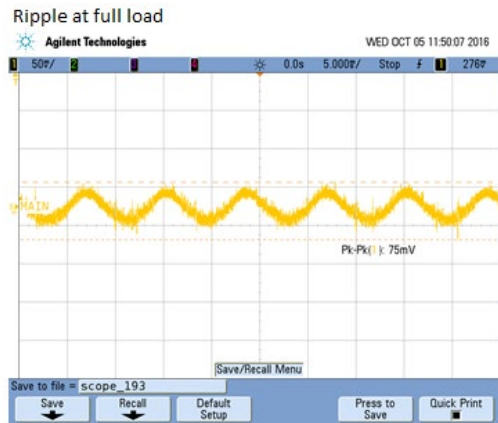

Transient Performance, 12V Model

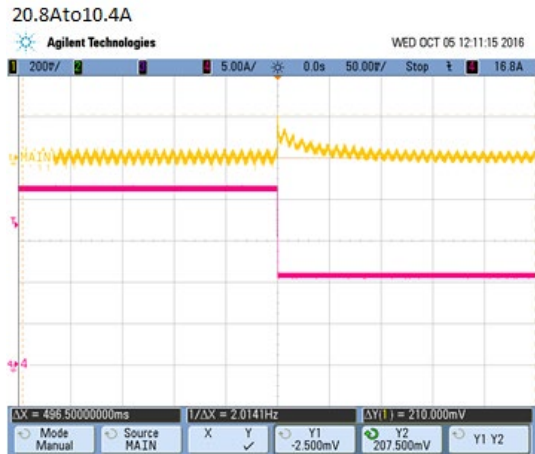

Transient Performance, 12V Model

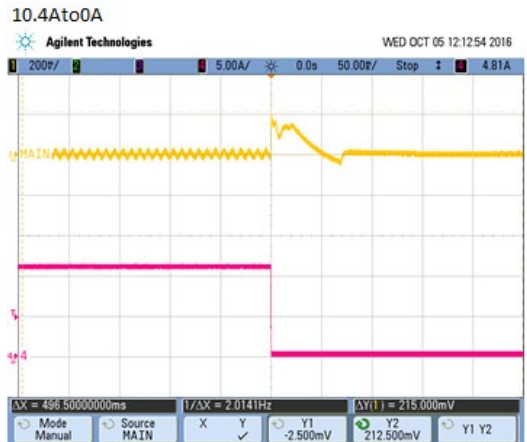

PERFORMANCE DATA

Start Up Performance , 12V Model shown

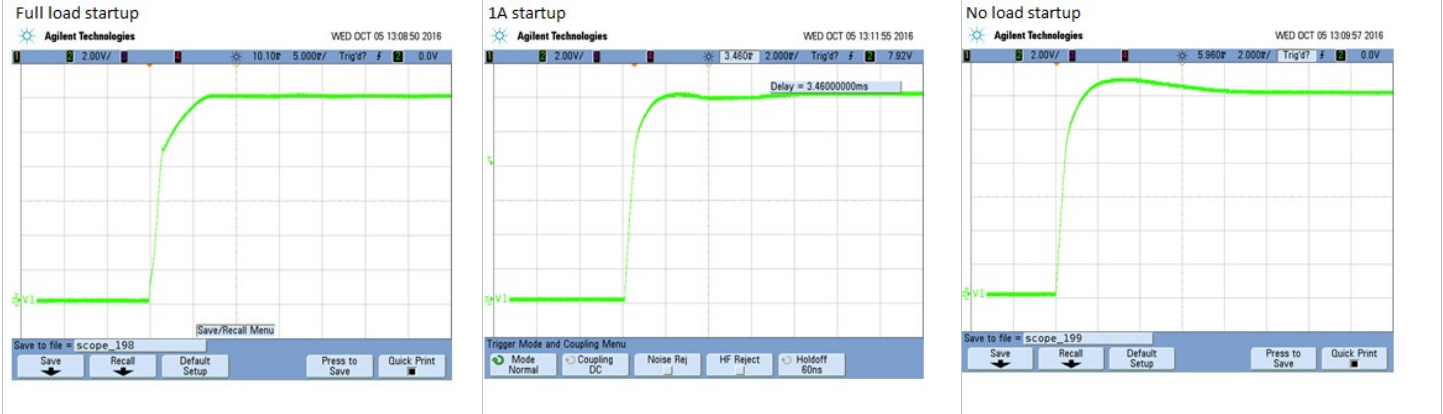

CONSTANT CURRENT OVERLOAD PERFORMANCE DATA; PQC250-xxC VARIANTS

The "C" option variant provides an overload (abnormal) Constant Current (CC) characteristic as shown in the following curves. This option will enable the PQC250 to successfully operate (at initial startup or during normal operation) in applications experiencing (large current) transient loads such as:

- Large capacitive loads
- Incandescent (i.e. halogen) lamps
- Inductive loads (motors and solenoids)
- LED driver sources

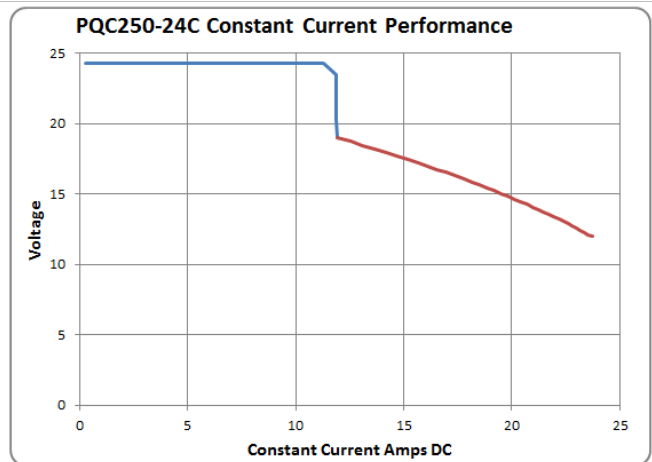
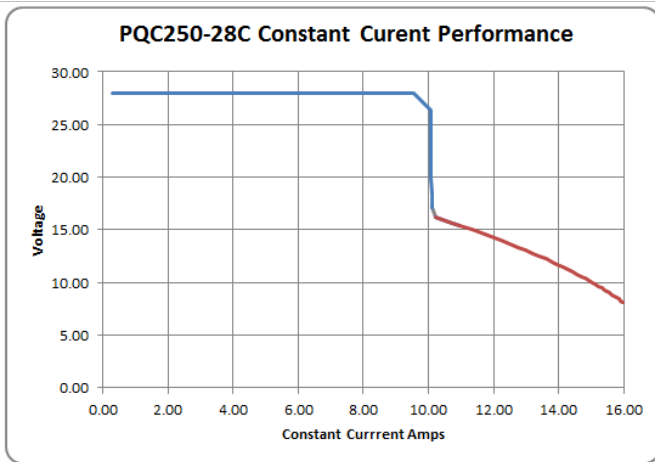

1. Curves generated for the PQC250-xxC variants by subjecting output to an incremental load (constant resistance) equivalent to 1Adc increments between 0A and 50A dc.
2. The resultant curve shows current limited to a constant "brick wall" shown by the blue portion of the curves.
3. If the load current is further incremented the current is still limited but will "tail" and result in the red portion of the curves. End Users should be aware of the potential magnitude of the "current tail" and rate their track/trace and/or interconnection cables accordingly.
4. If the overload (abnormal) current is maintained above maximum load for an extended period then internal over temperature protection may (will) shut down the output to prevent potential thermal overstress of components and maintain safe and reliable operation.

### THERMAL CONSIDERATIONS

System thermal management is critical to the performance and reliability of the PQC250 series power supplies. Performance [derating curves](#) are provided which can be used as a guideline for what can be achieved in a system configuration with controlled airflow at various input voltage conditions.

The product is designed to provide 250W using natural convection cooling when mounted horizontally with un-obstructed convection current airflow flow at room temperature. At elevated temperature the power supply data is taken while it is surrounded by a large vented enclosure to minimize forced cross flows inherent in the elevated temperature test.

The product is capable of operation when mounted in other orientations; operational/derating curves shall be provided to show the effect of such mounting. See [ACAN-77](#) for additional details

#### Capacitor case temperature and Mounting Orientation:

The power supply can operate in any orientation; however, the power supply contains overtemperature protection that will shut off the output as the temperature of the power supply heatsinks approach the limit specified in the [protection table](#). Additionally, life expectancy of the power supply is inversely proportional to the case temperature of electrolytic capacitors [C25](#), [C25A](#), [C711](#) & [C712](#). The designer of the system in which this power supply is deployed should consider this relationship to ensure optimum product life. The following charts illustrate this relationship:

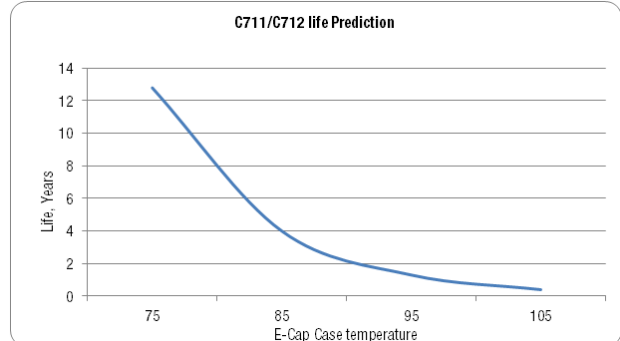
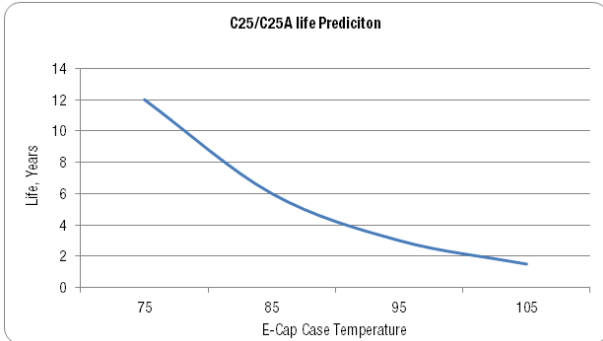

The PQC250 Series will also benefit from the provision of forced cooling airflow (generated by an external host system fan). This will enable operation at potentially higher local surrounding ambient temperatures.

Please refer to [ACAN-78](#) for additional details

Derating Curve vs. Temperature (based on horizontal mounting, PTH components facing up, natural convection)

Derating curves are provided to indicate operation at varying input voltages with respect to temperature. See [ACAN-77](#) for more details

Link [Back to Thermal Considerations](#); [Ordering Guide](#)

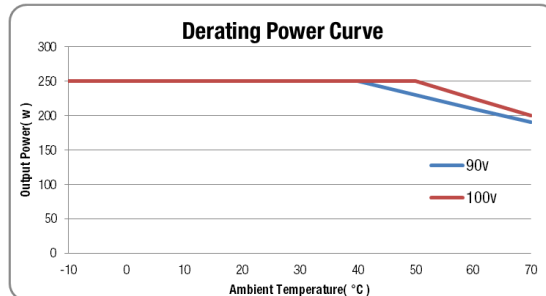

WIRING DIAGRAM FOR OUTPUT

PQC250-xx

Dotted lines show optional remote sense connections, that can be extended to the Point of Load (POL) which can be some physical distance from the power module output connector (J2). The intent is to compensate for any voltage drop in the cables to the to maintain voltage regulation at the POL .

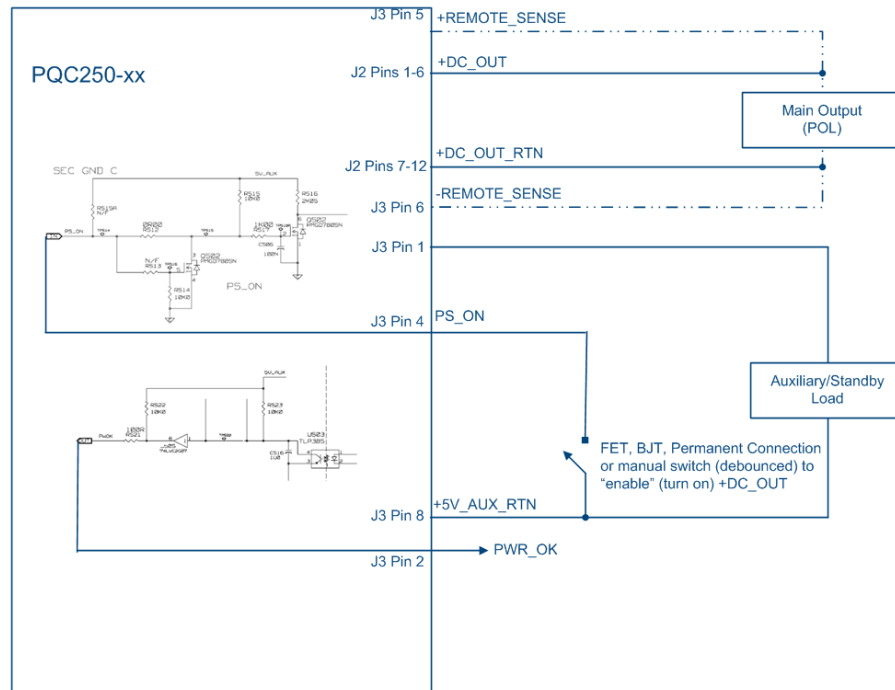

PQC250-xxC

Dotted lines show optional remote sense connections, that can be extended to the Point of Load (POL) which can be some physical distance from the power module output connector (J2). The intent is to compensate for any voltage drop in the cables to the to maintain voltage regulation at the POL .

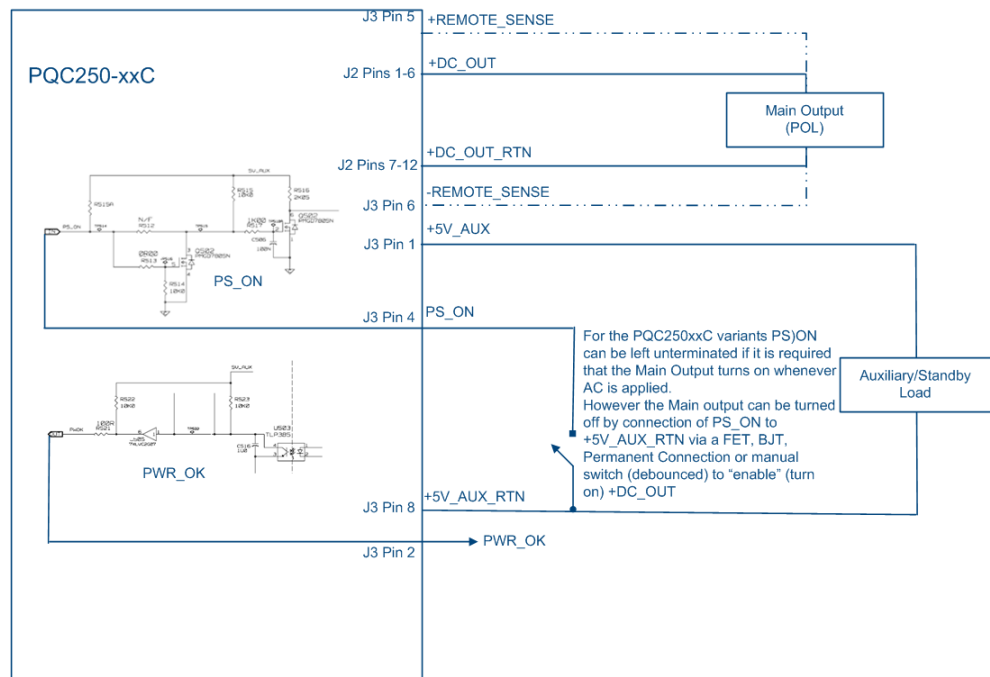

Note: For parallel (current share) operation it is required to connect the sharing power supplies in parallel (+DC out connected together and DC out Return connected together on sharing power supplies. Since each output has an identical "droop" share characteristic then each output will intrinsically share the total load current. See [ACAN-78](#) for more details.

**MECHANICAL DIMENSIONS (Nominal)**

**PQC250-xx and PQC250-xxD MODELS**

[Link Back to Description](#)

[Link Back to Thermal Considerations](#)

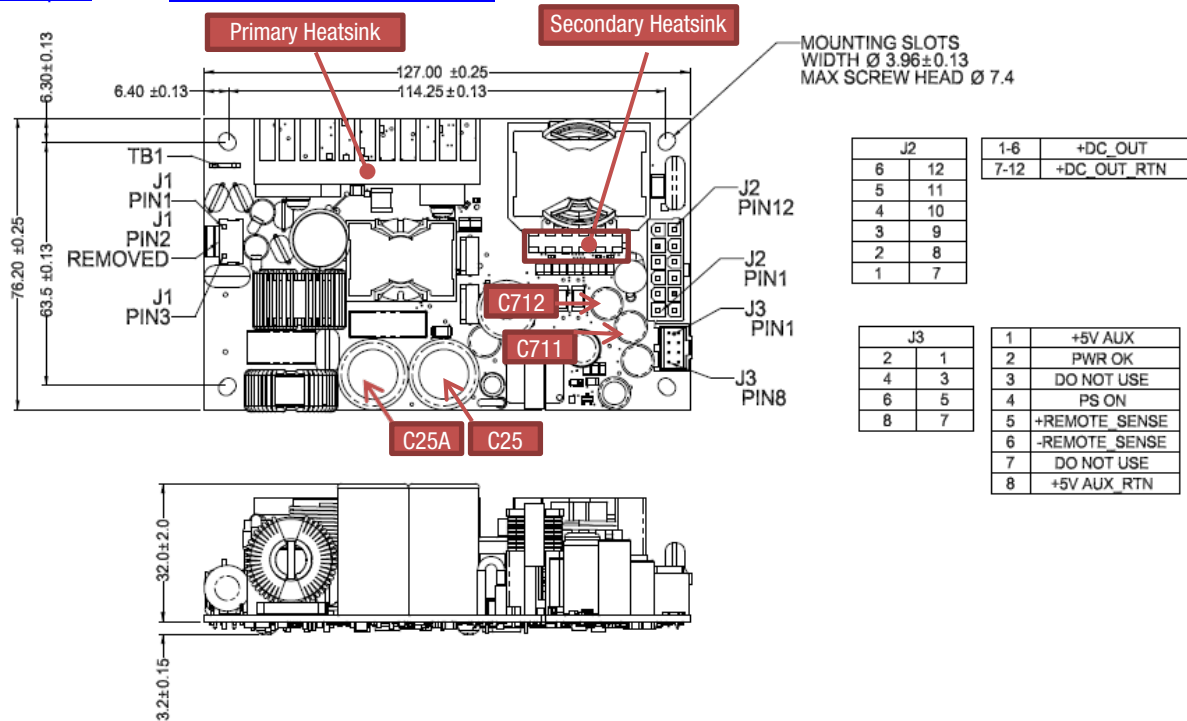

**PQC250-xyRT MODELS**

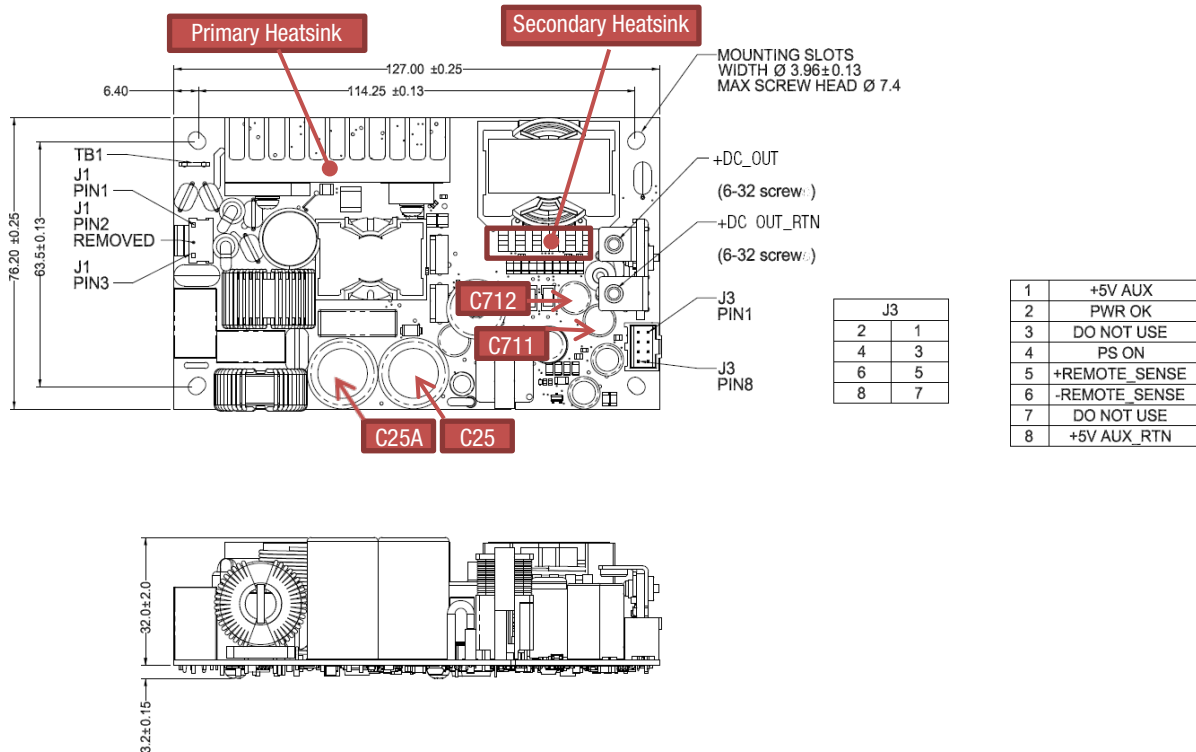



### SAFETY CONSIDERATIONS



1. This power supply is a component level power supply intended for use in Class I or Class II applications. Secondary ground traces need to be suitably isolated from primary ground traces when used in Class II applications.
2. When the power supply is used in Class II equipment, all ground traces and components connected to the primary side are considered primary for spacing and insulation considerations.
3. Protective bonding conductor from the end product protective earthing terminal must be tied to TB1. For optimum EMI performance, while maintaining Class I safety isolation all 4 mounting holes must be tied to the end product protective earthing terminal. To maintain Class II safety isolation mounting holes MTG1 and MTG2 need to be isolated from protective earth and should use standoffs of non-conductive material.
4. This power supply requires mounting standoffs of minimum 6mm in height. If there is risk of chassis deformation or shorter standoff height is required, an appropriate insulator must be used under the power supply with adequate extension beyond the outline of the power supply. In all cases, the applicable safety standards must be applied to ensure proper creepage and clearance requirements are met.
5. The primary heatsink is considered a live primary circuit, and should not be touched. It is recommended that the primary heatsink be kept at least 3.5mm from chassis, and 7mm from secondary circuits. In all cases, the applicable safety standards must be applied to ensure proper creepage and clearance requirements are met.
6. This product is subject to the following operating requirements and the Life and Safety Critical Application Sales Policy: <http://www.murata-ps.com/requirements/>
7. Used only in non-tropical conditions.

### INPUT/OUTPUT CONNECTOR AND SIGNAL SPECIFICATION AND MATING CONNECTORS – PQC250 series

Connector	PIN	Description	Mating Housing	Crimp terminal/pins
Input Connector J1: Molex 26-62-4030	1	AC Neutral	Molex 0009930300	Molex 0008500105 (18-24 AWG) Molex 0008500107 (22-26 AWG)
	3	AC Line		
Output Connector J2: Molex 39-28-1123	1,2,3,4,5,6	+DC_OUT	Molex 0039012125	Molex 0039000038
	7,8,9,10,11,12	+DC_OUT_RTN		
Output Connector J3: Molex 90130-1108	1	+5V_AUX	Molex 0901420008	Molex 0901190109
	2	PWR_OK		
	3	DO NOT USE		
	4	PS_ON		
	5	+Remote Sense		
	6	-Remote Sense		
	7	DO NOT USE		
8	+5V_AUX_RTN			

### APPLICATION NOTES

Document Number	Description	Link to Document
ACAN-77	Thermal deployment notes	<a href="http://power.murata.com/datasheet?/data/apnotes/acan-77.pdf">http://power.murata.com/datasheet?/data/apnotes/acan-77.pdf</a>
ACAN-78	Current Sharing deployment notes	<a href="http://power.murata.com/datasheet?/data/apnotes/acan-78.pdf">http://power.murata.com/datasheet?/data/apnotes/acan-78.pdf</a>
PQC-COVER	cover kit assembly datasheet	<a href="https://power.murata.com/data/acdcsupplies/pqc250-cover.pdf">https://power.murata.com/data/acdcsupplies/pqc250-cover.pdf</a>

Links back to:

- [Thermal Considerations](#)
- [Order Guide](#)
- [Current Sharing Option](#)

This product is subject to the following operating requirements and the Life and Safety Critical Application Sales Policy. Refer to: <http://www.murata-ps.com/requirements/>



Murata Power Solutions, Inc.  
129 Flanders Road  
Westborough, MA 01581  
ISO 9001 and 14001 REGISTERED

Murata Power Solutions, Inc. ("Murata") makes no representation that the use of its products in the circuits described herein, or the use of other technical information contained herein, will not infringe upon existing or future patent rights. The descriptions contained herein do not imply the granting of licenses to make, use, or sell equipment constructed in accordance therewith. Buyer represents and agrees that it has all the necessary expertise to create and implement safeguards that anticipate dangerous consequences of failures, monitor failures and their consequences, lessen the likelihood of failures that might cause harm, and take appropriate remedial actions. Buyer will fully indemnify Murata, its affiliated companies, and its representatives against any damages arising out of the use of any Murata products in safety-critical applications. Specifications are subject to change without notice.

Customer hereby acknowledges and agrees that Murata has not made, and will not make, any representations, warranties, covenants or other statements that would in any way indicate that the Products are suitable for use in connection with medical devices, medical equipment or for any other medical purposes, whether as a stand-alone product, or combined in any way with another good, product, part, hardware or otherwise, and, to the extent permitted by applicable law, Customer hereby expressly assumes any and all liability for any and all such use of the Products.

© 2020 Murata Power Solutions, Inc.