

MOSFET – N-Channel, POWERTRENCH[®], GreenBridge™ Series of High-Efficiency Bridge Rectifiers

100 V, 6 A, 110 mΩ

FDMQ8403

General Description

This quad MOSFET solution provides ten-fold improvement in power dissipation over diode bridge.

Features

- Max $r_{DS(on)}$ = 110 mΩ at $V_{GS} = 10$ V, $I_D = 3$ A
- Max $r_{DS(on)}$ = 175 mΩ at $V_{GS} = 6$ V, $I_D = 2.4$ A
- Substantial Efficiency Benefit in PD Solutions
- This Device is Pb-Free, Halid Free and is RoHS Compliant

Applications

- High-Efficiency Bridge Rectifiers

MOSFET MAXIMUM RATINGS ($T_A = 25^\circ\text{C}$ unless otherwise noted)

Symbol	Rating	Value	Unit
V_{DS}	Drain to Source Voltage	100	V
V_{GS}	Gate to Source Voltage	±20	V
I_D	Drain Current – Continuous (Package Limited) $T_C = 25^\circ\text{C}$ – Continuous (Silicon Limited) $T_C = 25^\circ\text{C}$ – Continuous (Note 1a.) $T_A = 25^\circ\text{C}$ – Pulsed	6	A
		9	
		3.1	
		12	
P_D	Power Dissipation $T_C = 25^\circ\text{C}$	17	W
	Power Dissipation (Note 1a.) $T_A = 25^\circ\text{C}$	1.9	
T_J, T_{STG}	Operating and Storage Junction Temperature Range	–55 to +150	$^\circ\text{C}$

Stresses exceeding those listed in the Maximum Ratings table may damage the device. If any of these limits are exceeded, device functionality should not be assumed, damage may occur and reliability may be affected.

THERMAL CHARACTERISTICS

Symbol	Rating	Value	Unit
$R_{\theta JA}$	Thermal Resistance, Junction to Ambient (Note 1a.)	65	$^\circ\text{C}/\text{W}$
$R_{\theta JA}$	Thermal Resistance, Junction to Ambient (Note 1b.)	135	

V_{DSS}	$R_{DS(ON)}$ MAX	I_D MAX
100 V	110 Ω @ 10 V	6 A

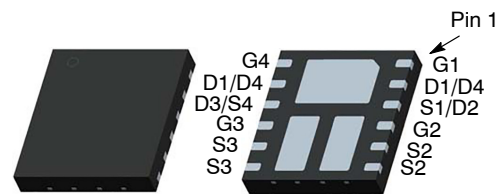

WDFN12 5 x 4.5, 0.8P
(MLP 4.5 x 5)
CASE 511CR

MARKING DIAGRAM

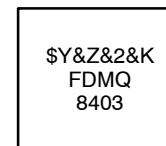

- FDMQ8403 = Specific Device Code
 \$Y = onsemi Logo
 &Z = Assembly plant code
 &2 = Date Code format (Year and Week)
 &K = Lot Run Traceability Code

PIN CONNECTION

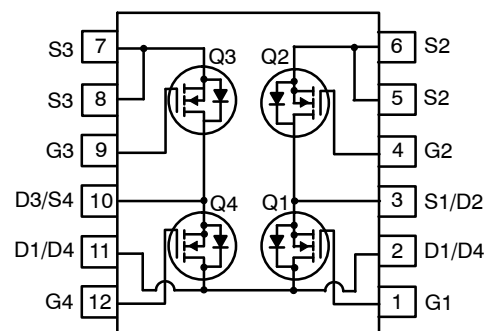

ORDERING INFORMATION

See detailed ordering and shipping information on page 5 of this data sheet.

FDMQ8403

ELECTRICAL CHARACTERISTICS (T_J = 25°C unless otherwise noted)

Symbol	Parameter	Test Condition	Min	Typ	Max	Unit
OFF CHARACTERISTICS						
BV _{DSS}	Drain to Source Breakdown Voltage	V _{GS} = 0 V, I _D = 250 μA	100	–	–	V
$\frac{\Delta BV_{DSS}}{\Delta T_J}$	Breakdown Voltage Temperature Coefficient	I _D = 250 μA, Referenced to 25°C	–	72	–	mV/°C
I _{DSS}	Zero Gate Voltage Drain Current	V _{GS} = 0 V, V _{DS} = 80 V	–	–	1	nA
I _{GSS}	Gate to Source Leakage Current	V _{GS} = ±20 V, V _{DS} = 0 V	–	–	±100	μA

OFF CHARACTERISTICS

V _{GS(th)}	Drain to Source Breakdown Voltage	V _{GS} = V _{DS} , I _D = 250 μA	2	2.8	4	V
$\frac{\Delta V_{GS(th)}}{\Delta T_J}$	Breakdown Voltage Temperature Coefficient	I _D = 250 μA, Referenced to 25°C	–	–8	–	mV/°C
r _{DS(on)}	Static Drain to Source On Resistance	V _{GS} = 10 V, I _D = 3 A	–	85	110	mΩ
		V _{GS} = 6 V, I _D = 2.4 A	–	115	175	
		V _{GS} = 10 V, I _D = 3 A, T _J = 125°C	–	147	191	
g _{FS}	Forward Transconductance	V _{DS} = 10 V, I _D = 3 A	–	6	–	S

DYNAMIC CHARACTERISTICS

C _{iss}	Input Capacitance	V _{DS} = 50 V, V _{GS} = 0 V, f = 1 MHz	–	162	215	pF
C _{oss}	Output Capacitance		–	43	60	pF
C _{rss}	Reverse Transfer Capacitance		–	2.6	5	pF

DYNAMIC CHARACTERISTICS

t _{d(on)}	Turn-On Delay Time	V _{DD} = 50 V, I _D = 3 A, V _{GS} = 10 V, R _{GEN} = 6 Ω	–	4.1	10	ns	
t _r	Rise Time		–	1.2	10	ns	
t _{d(off)}	Turn-Off Delay Time		–	7.2	15	ns	
t _f	Fall Time		–	1.8	10	ns	
Q _g	Total Gate Charge	V _{GS} = 0 V to 10 V	V _{DD} = 50 V, I _D = 3 A	–	3	5	nC
Q _g	Total Gate Charge	V _{GS} = 0 V to 5 V		–	1.7	3	nC
Q _{gs}	Gate to Source Charge	V _{DD} = 50 V, I _D = 3 A	–	0.9	–	nC	
Q _{gd}	Gate to Drain "Miller" Charge		–	0.8	–	nC	

DRAIN-SOURCE DIODE CHARACTERISTICS

V _{SD}	Source to Drain Diode Forward Voltage	V _{GS} = 0 V, I _S = 3 A (Note 2)	–	0.86	1.3	V
t _{rr}	Reverse Recovery Time	I _F = 3 A, di/dt = 100 A/μs	–	33	53	ns
Q _{rr}	Reverse Recovery Charge		–	23	37	nC

Product parametric performance is indicated in the Electrical Characteristics for the listed test conditions, unless otherwise noted. Product performance may not be indicated by the Electrical Characteristics if operated under different conditions.

- R_{θJA} is determined with the device mounted on a 1in² pad 2 oz copper pad on a 1.5 x 1.5 in. board of FR-4 material. R_{θJC} is guaranteed by design while R_{θCA} is determined by the user's board design.



a. 65°C/W when mounted on a 1 in² pad of 2 oz copper, the board designed Q1 + Q3 or Q2 + Q4.

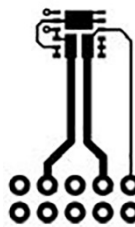

b. 135°C/W when mounted on a minimum pad of 2 oz copper, the board designed Q1 + Q3 or Q2 + Q4.

- Pulse Test: Pulse Width < 300 μs, Duty cycle < 2.0%.

TYPICAL CHARACTERISTICS ($T_J = 25^\circ\text{C}$ unless otherwise noted.)

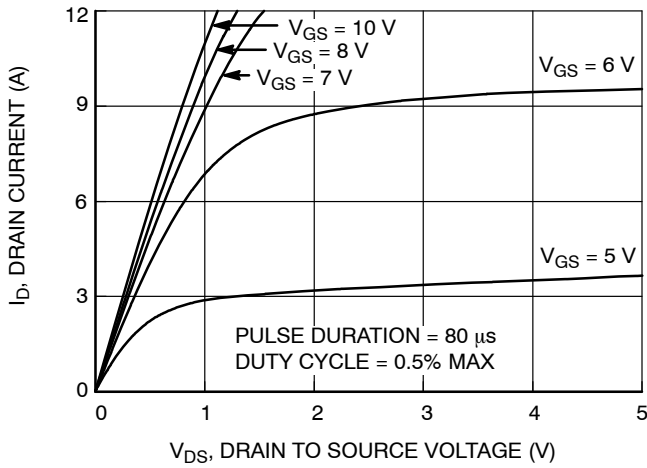

Figure 1. On Region Characteristics

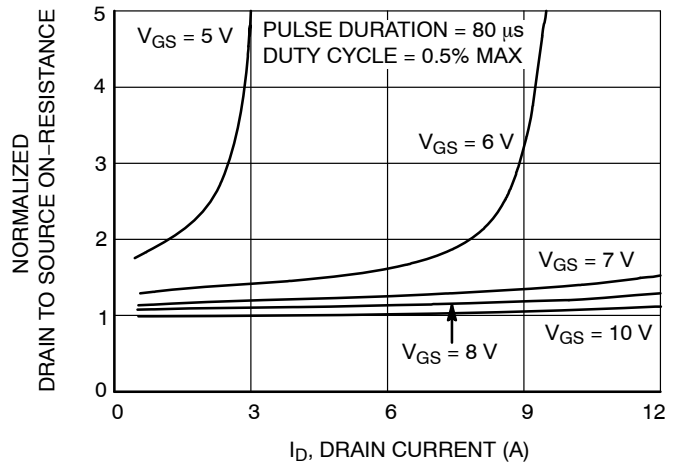

Figure 2. Normalized On-Resistance vs. Drain Current and Gate Voltage

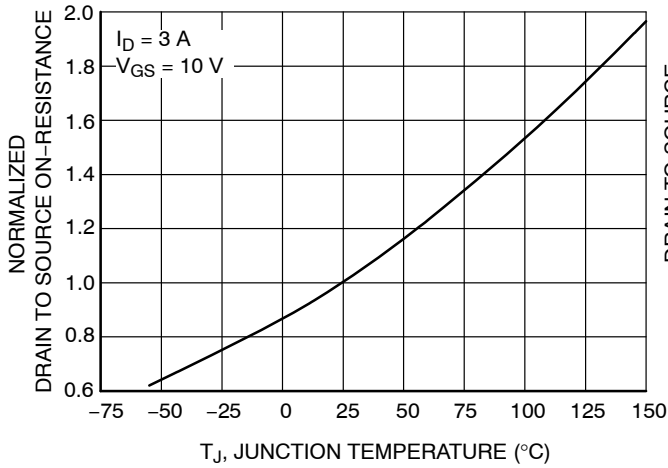

Figure 3. Normalized On Resistance vs. Junction Temperature

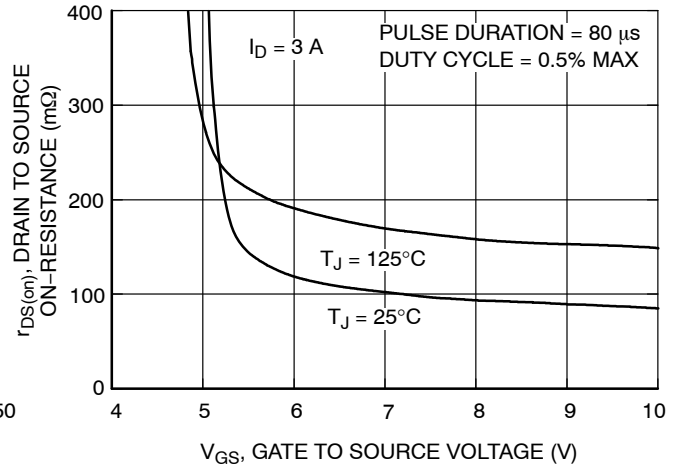

Figure 4. On-Resistance vs. Gate to Source Voltage

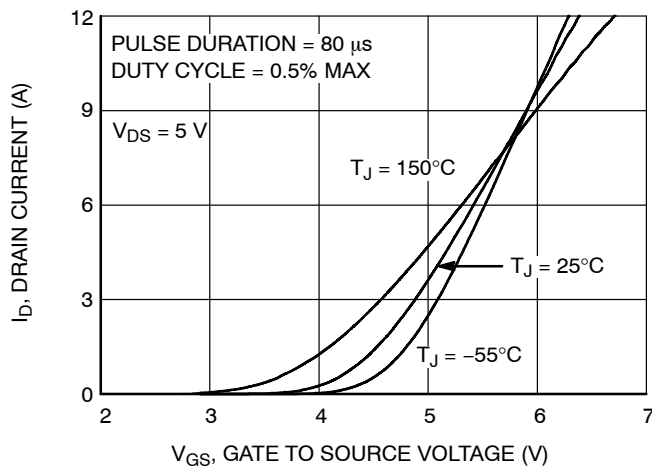

Figure 5. Transfer Characteristics

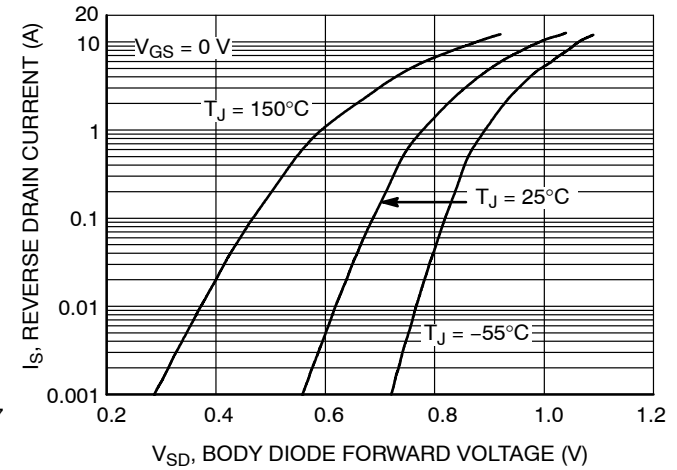

Figure 6. Source to Drain Diode Forward Voltage vs. Source Current

TYPICAL CHARACTERISTICS ($T_J = 25^\circ\text{C}$ unless otherwise noted) (continued)

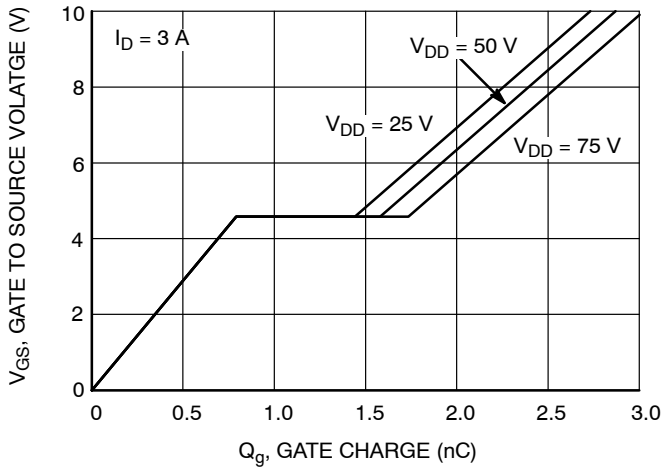

Figure 7. Gate Charge Characteristics

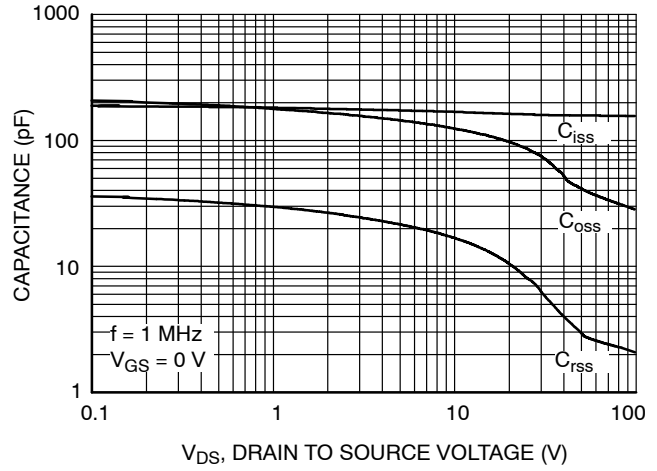

Figure 8. Capacitance vs. Drain to Source Voltage

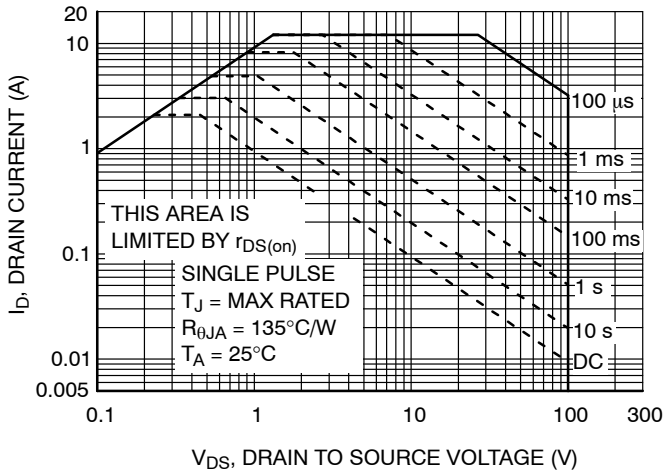

Figure 9. Forward Bias Safe Operating Area

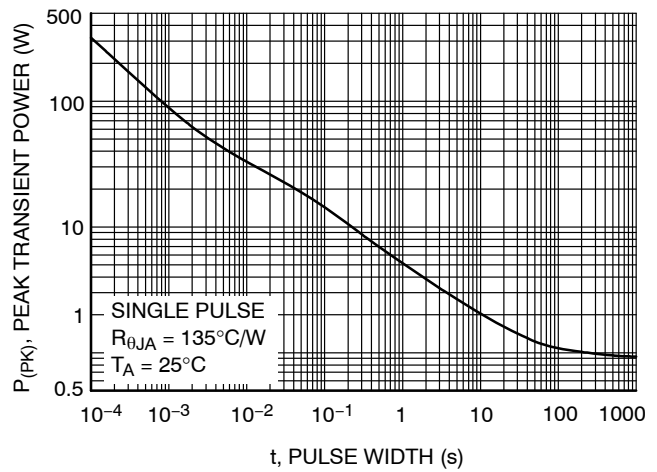

Figure 10. Single Pulse Maximum Power Dissipation

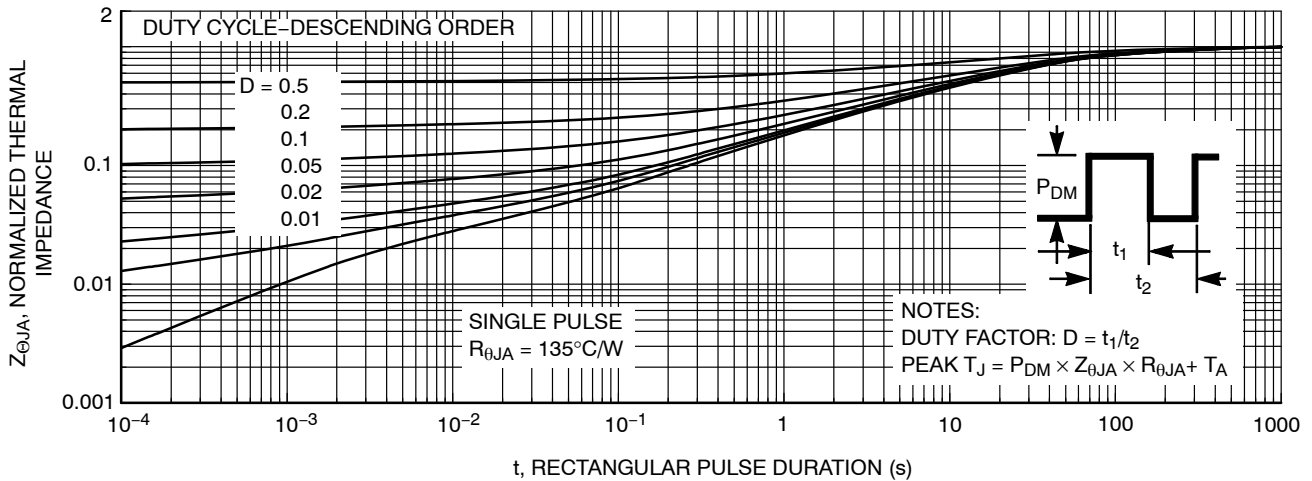

Figure 11. Junction-to-Ambient Transient Thermal Response Curve

FDMQ8403

ORDERING INFORMATION

Device Marking	Device	Package	Reel Size	Tape Width	Shipping [†]
FDMQ8403	FDMQ8403	WDFN12 (Pb-Free)	13"	12 mm	3000 / Tape & Reel

†For information on tape and reel specifications, including part orientation and tape sizes, please refer to our Tape and Reel Packaging Specifications Brochure, [BRD8011/D](#).

GreenBridge is a trademark of Semiconductor Components Industries, LLC dba "onsemi" or its affiliates and/or subsidiaries in the United States and/or other countries.

POWERTRENCH is a registered trademark of Semiconductor Components Industries, LLC dba "onsemi" or its affiliates and/or subsidiaries in the United States and/or other countries.



WDFN12 5x4.5, 0.8P
CASE 511CR
ISSUE A

DATE 21 MAR 2017

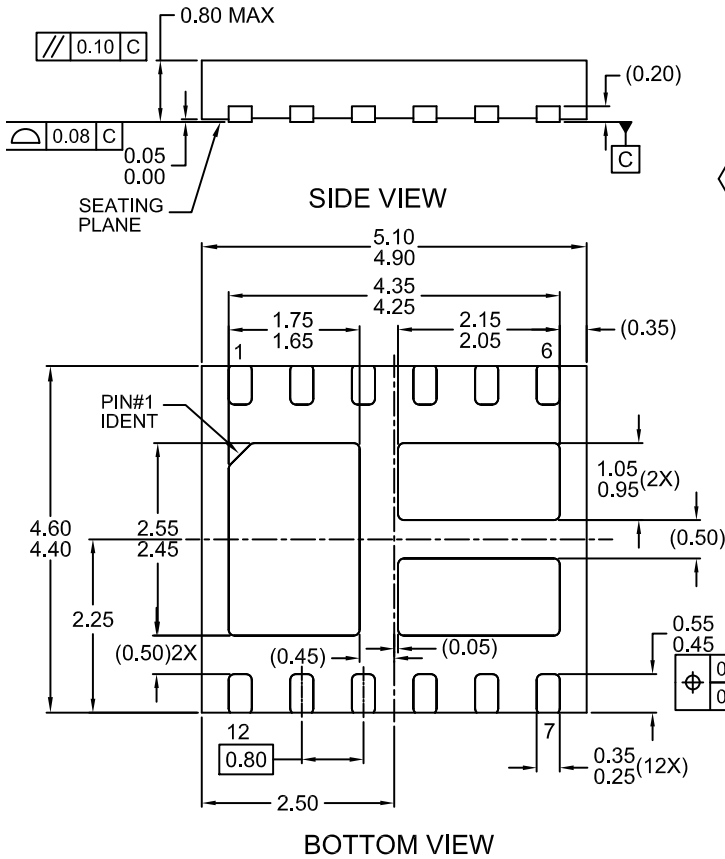
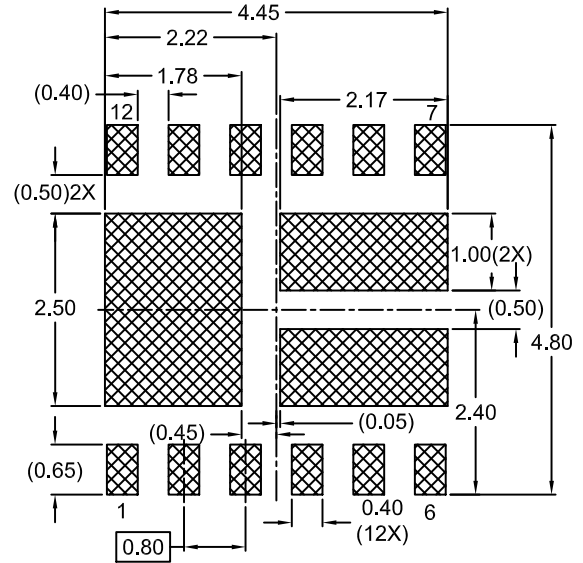
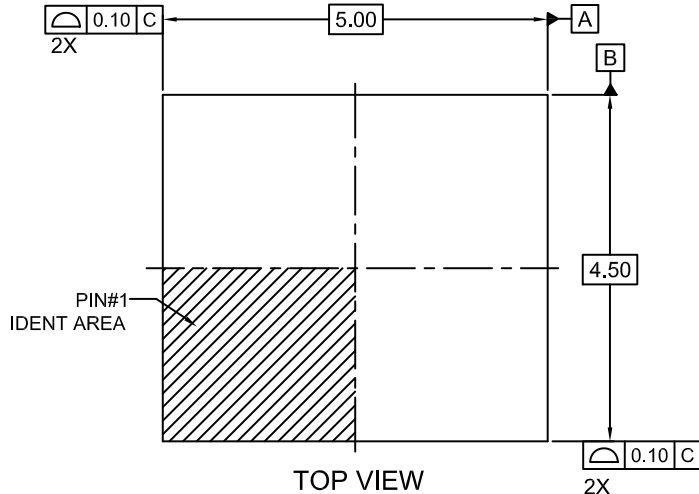

RECOMMENDED LAND PATTERN

- NOTES:
- A. THIS MKT. DWG. DOES NOT FULLY CONFORM TO JEDEC MO-229 REGISTRATION
 - B. DIMENSIONS ARE IN MILLIMETERS.
 - C. DIMENSIONS AND TOLERANCES PER ASME Y14.5M, 1994.

DOCUMENT NUMBER:	98AON13606G	Electronic versions are uncontrolled except when accessed directly from the Document Repository. Printed versions are uncontrolled except when stamped "CONTROLLED COPY" in red.
DESCRIPTION:	WDFN12 5X4.5, 0.8P	PAGE 1 OF 1

ON Semiconductor and ON are trademarks of Semiconductor Components Industries, LLC dba ON Semiconductor or its subsidiaries in the United States and/or other countries. ON Semiconductor reserves the right to make changes without further notice to any products herein. ON Semiconductor makes no warranty, representation or guarantee regarding the suitability of its products for any particular purpose, nor does ON Semiconductor assume any liability arising out of the application or use of any product or circuit, and specifically disclaims any and all liability, including without limitation special, consequential or incidental damages. ON Semiconductor does not convey any license under its patent rights nor the rights of others.

onsemi, **Onsemi**, and other names, marks, and brands are registered and/or common law trademarks of Semiconductor Components Industries, LLC dba "**onsemi**" or its affiliates and/or subsidiaries in the United States and/or other countries. **onsemi** owns the rights to a number of patents, trademarks, copyrights, trade secrets, and other intellectual property. A listing of **onsemi**'s product/patent coverage may be accessed at www.onsemi.com/site/pdf/Patent-Marking.pdf. **onsemi** reserves the right to make changes at any time to any products or information herein, without notice. The information herein is provided "as-is" and **onsemi** makes no warranty, representation or guarantee regarding the accuracy of the information, product features, availability, functionality, or suitability of its products for any particular purpose, nor does **onsemi** assume any liability arising out of the application or use of any product or circuit, and specifically disclaims any and all liability, including without limitation special, consequential or incidental damages. Buyer is responsible for its products and applications using **onsemi** products, including compliance with all laws, regulations and safety requirements or standards, regardless of any support or applications information provided by **onsemi**. "Typical" parameters which may be provided in **onsemi** data sheets and/or specifications can and do vary in different applications and actual performance may vary over time. All operating parameters, including "Typicals" must be validated for each customer application by customer's technical experts. **onsemi** does not convey any license under any of its intellectual property rights nor the rights of others. **onsemi** products are not designed, intended, or authorized for use as a critical component in life support systems or any FDA Class 3 medical devices or medical devices with a same or similar classification in a foreign jurisdiction or any devices intended for implantation in the human body. Should Buyer purchase or use **onsemi** products for any such unintended or unauthorized application, Buyer shall indemnify and hold **onsemi** and its officers, employees, subsidiaries, affiliates, and distributors harmless against all claims, costs, damages, and expenses, and reasonable attorney fees arising out of, directly or indirectly, any claim of personal injury or death associated with such unintended or unauthorized use, even if such claim alleges that **onsemi** was negligent regarding the design or manufacture of the part. **onsemi** is an Equal Opportunity/Affirmative Action Employer. This literature is subject to all applicable copyright laws and is not for resale in any manner.

PUBLICATION ORDERING INFORMATION

LITERATURE FULFILLMENT:

Email Requests to: orderlit@onsemi.com

onsemi Website: www.onsemi.com

TECHNICAL SUPPORT

North American Technical Support:

Voice Mail: 1 800-282-9855 Toll Free USA/Canada

Phone: 011 421 33 790 2910

Europe, Middle East and Africa Technical Support:

Phone: 00421 33 790 2910

For additional information, please contact your local Sales Representative