

## Two-Line ESD Protection in SOT-23

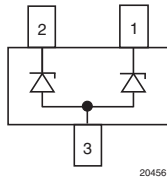

20456

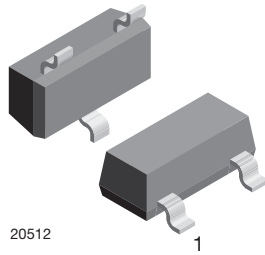

20512

1

### MARKING (example only)

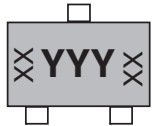

20357

YYY = type code (see table below)

XX = date code

### FEATURES

- Two-line ESD protection device
- ESD immunity acc. IEC 61000-4-2  
± 30 kV contact discharge  
± 30 kV air discharge
- ESD capability according to AEC-Q101:  
human body model: class H3B: > 8 kV
- Space saving SOT-23 package
- e3 - Sn
- AEC-Q101 qualified available
- Material categorization: for definitions of compliance please see [www.vishay.com/doc?99912](http://www.vishay.com/doc?99912)



### DESIGN SUPPORT TOOLS AVAILABLE



| ORDERING INFORMATION  |                                |                                 |       |            |   |   |                         |
|-----------------------|--------------------------------|---------------------------------|-------|------------|---|---|-------------------------|
| PART NUMBER (EXAMPLE) | ENVIRONMENTAL AND QUALITY CODE |                                 |       |            | PACKAGING CODE                            |   | ORDERING CODE (EXAMPLE) |
|                       | AEC-Q101 QUALIFIED             | RoHS-COMPLIANT + LEAD (Pb)-FREE |       | TIN PLATED | 3K PER 7" REEL (8 mm TAPE), 15K/BOX = MOQ | 10K PER 13" REEL (8 mm TAPE), 10K/BOX = MOQ |                         |
|                       |                                | STANDARD                        | GREEN |            |   |   |                         |
| GSOT05C-              |                                | E                               |       | 3          | -08                                       |   | GSOT05C-E3-08           |
| GSOT05C-              |                                |                                 | G     | 3          | -08                                       |   | GSOT05C-G3-08           |
| GSOT05C-              | H                              | E                               |       | 3          | -08                                       |   | GSOT05C-HE3-08          |
| GSOT05C-              | H                              |                                 | G     | 3          | -08                                       |   | GSOT05C-HG3-08          |
| GSOT05C-              |                                | E                               |       | 3          |   | -18   | GSOT05C-E3-18           |
| GSOT05C-              |                                |                                 | G     | 3          |   | -18   | GSOT05C-G3-18           |
| GSOT05C-              | H                              | E                               |       | 3          |   | -18   | GSOT05C-HE3-18          |
| GSOT05C-              | H                              |                                 | G     | 3          |   | -18   | GSOT05C-HG3-18          |

| PACKAGE DATA |              |           |                      |        |                                      |                                   |                              |
|--------------|--------------|-----------|----------------------|--------|--------------------------------------|-----------------------------------|------------------------------|
| DEVICE NAME  | PACKAGE NAME | TYPE CODE | ENVIRONMENTAL STATUS | WEIGHT | MOLDING COMPOUND FLAMMABILITY RATING | MOISTURE SENSITIVITY LEVEL        | SOLDERING CONDITIONS         |
| GSOT03C      | SOT-23       | 03C       | Standard             | 8.8 mg | UL 94 V-0                            | MSL level 1 (according J-STD-020) | Peak temperature max. 260 °C |
|              |              | C1G       | Green                | 8.1 mg |                                      |                                   |                              |
| GSOT04C      | SOT-23       | 04C       | Standard             | 8.8 mg | UL 94 V-0                            | MSL level 1 (according J-STD-020) | Peak temperature max. 260 °C |
|              |              | C8G       | Green                | 8.1 mg |                                      |                                   |                              |
| GSOT05C      | SOT-23       | 05C       | Standard             | 8.8 mg | UL 94 V-0                            | MSL level 1 (according J-STD-020) | Peak temperature max. 260 °C |
|              |              | C2G       | Green                | 8.1 mg |                                      |                                   |                              |
| GSOT08C      | SOT-23       | 08C       | Standard             | 8.8 mg | UL 94 V-0                            | MSL level 1 (according J-STD-020) | Peak temperature max. 260 °C |
|              |              | C3G       | Green                | 8.1 mg |                                      |                                   |                              |
| GSOT12C      | SOT-23       | 12C       | Standard             | 8.8 mg | UL 94 V-0                            | MSL level 1 (according J-STD-020) | Peak temperature max. 260 °C |
|              |              | C4G       | Green                | 8.1 mg |                                      |                                   |                              |
| GSOT15C      | SOT-23       | 15C       | Standard             | 8.8 mg | UL 94 V-0                            | MSL level 1 (according J-STD-020) | Peak temperature max. 260 °C |
|              |              | C5G       | Green                | 8.1 mg |                                      |                                   |                              |
| GSOT24C      | SOT-23       | 24C       | Standard             | 8.8 mg | UL 94 V-0                            | MSL level 1 (according J-STD-020) | Peak temperature max. 260 °C |
|              |              | C6G       | Green                | 8.1 mg |                                      |                                   |                              |
| GSOT36C      | SOT-23       | 36C       | Standard             | 8.8 mg | UL 94 V-0                            | MSL level 1 (according J-STD-020) | Peak temperature max. 260 °C |
|              |              | C7G       | Green                | 8.1 mg |                                      |                                   |                              |



| ABSOLUTE MAXIMUM RATINGS GSOT03C |   |           |             |             |
|----------------------------------|---|-----------|-------------|-------------|
| PARAMETER                        | TEST CONDITIONS   | SYMBOL    | VALUE       | UNIT        |
| Peak pulse current               | Pin 1 to 3 or pin 2 to 3<br>acc. IEC 61000-4-5, $t_p = 8/20 \mu s$ ; single shot                      | $I_{PPM}$ | 30          | A           |
|                                  | Pin 1 to 2 or pin 2 to 1; pin 3 not connected<br>acc. IEC 61000-4-5, $t_p = 8/20 \mu s$ ; single shot |           | 30          | A           |
| Peak pulse power                 | Pin 1 to 3 or pin 2 to 3<br>acc. IEC 61000-4-5, $t_p = 8/20 \mu s$ ; single shot                      | $P_{PP}$  | 369         | W           |
|                                  | Pin 1 to 2 or pin 2 to 1; pin 3 not connected<br>acc. IEC 61000-4-5, $t_p = 8/20 \mu s$ ; single shot |           | 504         | W           |
| ESD immunity                     | Contact discharge acc. IEC 61000-4-2; 10 pulses   | $V_{ESD}$ | $\pm 30$    | kV          |
|                                  | Air discharge acc. IEC 61000-4-2; 10 pulses   |           | $\pm 30$    | kV          |
| Operating temperature            | Junction temperature  | $T_J$     | -55 to +150 | $^{\circ}C$ |
| Storage temperature              |   | $T_{STG}$ | -55 to +150 | $^{\circ}C$ |

| ABSOLUTE MAXIMUM RATINGS GSOT04C |   |           |             |             |
|----------------------------------|---|-----------|-------------|-------------|
| PARAMETER                        | TEST CONDITIONS   | SYMBOL    | VALUE       | UNIT        |
| Peak pulse current               | Pin 1 to 3 or pin 2 to 3<br>acc. IEC 61000-4-5, $t_p = 8/20 \mu s$ ; single shot                      | $I_{PPM}$ | 30          | A           |
|                                  | Pin 1 to 2 or pin 2 to 1; pin 3 not connected<br>acc. IEC 61000-4-5, $t_p = 8/20 \mu s$ ; single shot |           | 30          | A           |
| Peak pulse power                 | Pin 1 to 3 or pin 2 to 3<br>acc. IEC 61000-4-5, $t_p = 8/20 \mu s$ ; single shot                      | $P_{PP}$  | 429         | W           |
|                                  | Pin 1 to 2 or pin 2 to 1; pin 3 not connected<br>acc. IEC 61000-4-5, $t_p = 8/20 \mu s$ ; single shot |           | 564         | W           |
| ESD immunity                     | Contact discharge acc. IEC 61000-4-2; 10 pulses   | $V_{ESD}$ | $\pm 30$    | kV          |
|                                  | Air discharge acc. IEC 61000-4-2; 10 pulses   |           | $\pm 30$    | kV          |
| Operating temperature            | Junction temperature  | $T_J$     | -55 to +150 | $^{\circ}C$ |
| Storage temperature              |   | $T_{STG}$ | -55 to +150 | $^{\circ}C$ |

| ABSOLUTE MAXIMUM RATINGS GSOT05C |   |           |             |             |
|----------------------------------|---|-----------|-------------|-------------|
| PARAMETER                        | TEST CONDITIONS   | SYMBOL    | VALUE       | UNIT        |
| Peak pulse current               | Pin 1 to 3 or pin 2 to 3<br>acc. IEC 61000-4-5, $t_p = 8/20 \mu s$ ; single shot                      | $I_{PPM}$ | 30          | A           |
|                                  | Pin 1 to 2 or pin 2 to 1; pin 3 not connected<br>acc. IEC 61000-4-5, $t_p = 8/20 \mu s$ ; single shot |           | 30          | A           |
| Peak pulse power                 | Pin 1 to 3 or pin 2 to 3<br>acc. IEC 61000-4-5, $t_p = 8/20 \mu s$ ; single shot                      | $P_{PP}$  | 480         | W           |
|                                  | Pin 1 to 2 or pin 2 to 1; pin 3 not connected<br>acc. IEC 61000-4-5, $t_p = 8/20 \mu s$ ; single shot |           | 612         | W           |
| ESD immunity                     | Contact discharge acc. IEC 61000-4-2; 10 pulses   | $V_{ESD}$ | $\pm 30$    | kV          |
|                                  | Air discharge acc. IEC 61000-4-2; 10 pulses   |           | $\pm 30$    | kV          |
| Operating temperature            | Junction temperature  | $T_J$     | -55 to +150 | $^{\circ}C$ |
| Storage temperature              |   | $T_{STG}$ | -55 to +150 | $^{\circ}C$ |



| <b>ABSOLUTE MAXIMUM RATINGS GSOT08C</b> |   |           |             |                    |
|---|---|-----------|-------------|--------------------|
| PARAMETER                               | TEST CONDITIONS   | SYMBOL    | VALUE       | UNIT               |
| Peak pulse current                      | Pin 1 to 3 or pin 2 to 3<br>acc. IEC 61000-4-5, $t_p = 8/20 \mu\text{s}$ ; single shot                      | $I_{PPM}$ | 18          | A                  |
|   | Pin 1 to 2 or pin 2 to 1; pin 3 not connected<br>acc. IEC 61000-4-5, $t_p = 8/20 \mu\text{s}$ ; single shot |           | 18          | A                  |
| Peak pulse power                        | Pin 1 to 3 or pin 2 to 3<br>acc. IEC 61000-4-5, $t_p = 8/20 \mu\text{s}$ ; single shot                      | $P_{PP}$  | 345         | W                  |
|   | Pin 1 to 2 or pin 2 to 1; pin 3 not connected<br>acc. IEC 61000-4-5, $t_p = 8/20 \mu\text{s}$ ; single shot |           | 400         | W                  |
| ESD immunity                            | Contact discharge acc. IEC 61000-4-2; 10 pulses   | $V_{ESD}$ | $\pm 30$    | kV                 |
|   | Air discharge acc. IEC 61000-4-2; 10 pulses   |           | $\pm 30$    | kV                 |
| Operating temperature                   | Junction temperature  | $T_J$     | -55 to +150 | $^{\circ}\text{C}$ |
| Storage temperature                     |   | $T_{STG}$ | -55 to +150 | $^{\circ}\text{C}$ |

| <b>ABSOLUTE MAXIMUM RATINGS GSOT12C</b> |   |           |             |                    |
|---|---|-----------|-------------|--------------------|
| PARAMETER                               | TEST CONDITIONS   | SYMBOL    | VALUE       | UNIT               |
| Peak pulse current                      | Pin 1 to 3 or pin 2 to 3<br>acc. IEC 61000-4-5, $t_p = 8/20 \mu\text{s}$ ; single shot                      | $I_{PPM}$ | 12          | A                  |
|   | Pin 1 to 2 or pin 2 to 1; pin 3 not connected<br>acc. IEC 61000-4-5, $t_p = 8/20 \mu\text{s}$ ; single shot |           | 12          | A                  |
| Peak pulse power                        | Pin 1 to 3 or pin 2 to 3<br>acc. IEC 61000-4-5, $t_p = 8/20 \mu\text{s}$ ; single shot                      | $P_{PP}$  | 312         | W                  |
|   | Pin 1 to 2 or pin 2 to 1; pin 3 not connected<br>acc. IEC 61000-4-5, $t_p = 8/20 \mu\text{s}$ ; single shot |           | 337         | W                  |
| ESD immunity                            | Contact discharge acc. IEC 61000-4-2; 10 pulses   | $V_{ESD}$ | $\pm 30$    | kV                 |
|   | Air discharge acc. IEC 61000-4-2; 10 pulses   |           | $\pm 30$    | kV                 |
| Operating temperature                   | Junction temperature  | $T_J$     | -55 to +150 | $^{\circ}\text{C}$ |
| Storage temperature                     |   | $T_{STG}$ | -55 to +150 | $^{\circ}\text{C}$ |

| <b>ABSOLUTE MAXIMUM RATINGS GSOT15C</b> |   |           |             |                    |
|---|---|-----------|-------------|--------------------|
| PARAMETER                               | TEST CONDITIONS   | SYMBOL    | VALUE       | UNIT               |
| Peak pulse current                      | Pin 1 to 3 or pin 2 to 3<br>acc. IEC 61000-4-5, $t_p = 8/20 \mu\text{s}$ ; single shot                      | $I_{PPM}$ | 8           | A                  |
|   | Pin 1 to 2 or pin 2 to 1; pin 3 not connected<br>acc. IEC 61000-4-5, $t_p = 8/20 \mu\text{s}$ ; single shot |           | 8           | A                  |
| Peak pulse power                        | Pin 1 to 3 or pin 2 to 3<br>acc. IEC 61000-4-5, $t_p = 8/20 \mu\text{s}$ ; single shot                      | $P_{PP}$  | 345         | W                  |
|   | Pin 1 to 2 or pin 2 to 1; pin 3 not connected<br>acc. IEC 61000-4-5, $t_p = 8/20 \mu\text{s}$ ; single shot |           | 400         | W                  |
| ESD immunity                            | Contact discharge acc. IEC 61000-4-2; 10 pulses   | $V_{ESD}$ | $\pm 30$    | kV                 |
|   | Air discharge acc. IEC 61000-4-2; 10 pulses   |           | $\pm 30$    | kV                 |
| Operating temperature                   | Junction temperature  | $T_J$     | -55 to +150 | $^{\circ}\text{C}$ |
| Storage temperature                     |   | $T_{STG}$ | -55 to +150 | $^{\circ}\text{C}$ |



| ABSOLUTE MAXIMUM RATINGS GSOT24C |   |           |             |             |
|----------------------------------|---|-----------|-------------|-------------|
| PARAMETER                        | TEST CONDITIONS   | SYMBOL    | VALUE       | UNIT        |
| Peak pulse current               | Pin 1 to 3 or pin 2 to 3<br>acc. IEC 61000-4-5, $t_p = 8/20 \mu s$ ; single shot                      | $I_{PPM}$ | 5           | A           |
|                                  | Pin 1 to 2 or pin 2 to 1; pin 3 not connected<br>acc. IEC 61000-4-5, $t_p = 8/20 \mu s$ ; single shot |           | 5           | A           |
| Peak pulse power                 | Pin 1 to 3 or pin 2 to 3<br>acc. IEC 61000-4-5, $t_p = 8/20 \mu s$ ; single shot                      | $P_{PP}$  | 235         | W           |
|                                  | Pin 1 to 2 or pin 2 to 1; pin 3 not connected<br>acc. IEC 61000-4-5, $t_p = 8/20 \mu s$ ; single shot |           | 240         | W           |
| ESD immunity                     | Contact discharge acc. IEC 61000-4-2; 10 pulses   | $V_{ESD}$ | $\pm 30$    | kV          |
|                                  | Air discharge acc. IEC 61000-4-2; 10 pulses   |           | $\pm 30$    | kV          |
| Operating temperature            | Junction temperature  | $T_J$     | -55 to +150 | $^{\circ}C$ |
| Storage temperature              |   | $T_{STG}$ | -55 to +150 | $^{\circ}C$ |

| ABSOLUTE MAXIMUM RATINGS GSOT36C |   |           |             |             |
|----------------------------------|---|-----------|-------------|-------------|
| PARAMETER                        | TEST CONDITIONS   | SYMBOL    | VALUE       | UNIT        |
| Peak pulse current               | Pin 1 to 3 or pin 2 to 3<br>acc. IEC 61000-4-5, $t_p = 8/20 \mu s$ ; single shot                      | $I_{PPM}$ | 3.5         | A           |
|                                  | Pin 1 to 2 or pin 2 to 1; pin 3 not connected<br>acc. IEC 61000-4-5, $t_p = 8/20 \mu s$ ; single shot |           | 3.5         | A           |
| Peak pulse power                 | Pin 1 to 3 or pin 2 to 3<br>acc. IEC 61000-4-5, $t_p = 8/20 \mu s$ ; single shot                      | $P_{PP}$  | 248         | W           |
|                                  | Pin 1 to 2 or pin 2 to 1; pin 3 not connected<br>acc. IEC 61000-4-5, $t_p = 8/20 \mu s$ ; single shot |           | 252         | W           |
| ESD immunity                     | Contact discharge acc. IEC 61000-4-2; 10 pulses   | $V_{ESD}$ | $\pm 30$    | kV          |
|                                  | Air discharge acc. IEC 61000-4-2; 10 pulses   |           | $\pm 30$    | kV          |
| Operating temperature            | Junction temperature  | $T_J$     | -55 to +150 | $^{\circ}C$ |
| Storage temperature              |   | $T_{STG}$ | -55 to +150 | $^{\circ}C$ |

### BiAs-MODE (2-line Bidirectional Asymmetrical protection mode)

With the GSOTxxC two signal- or data-lines (L1, L2) can be protected against voltage transients. With pin 3 connected to ground and pin 1 and pin 2 connected to a signal- or data-line which has to be protected. As long as the voltage level on the data- or signal-line is between 0 V (ground level) and the specified Maximum Reverse Working Voltage ( $V_{RWM}$ ) the protection diode between pin 2 and pin 3 and between pin 1 and pin 3 offers a high isolation to the ground line. The protection device behaves like an open switch.

As soon as any positive transient voltage signal exceeds the breakdown voltage level of the protection diode, the diode becomes conductive and shorts the transient current to ground. Now the protection device behaves like a closed switch. The Clamping Voltage ( $V_C$ ) is defined by the breakdown voltage ( $V_{BR}$ ) level plus the voltage drop at the series impedance (resistance and inductance) of the protection diode.

Any negative transient signal will be clamped accordingly. The negative transient current is flowing in the forward direction through the protection diode. The low Forward Voltage ( $V_F$ ) clamps the negative transient close to the ground level.

Due to the different clamping levels in forward and reverse direction the GSOTxxC clamping behavior is Bidirectional and Asymmetrical (BiAs).



20358

If a higher surge current or peak pulse current ( $I_{PP}$ ) is needed, both protection diodes in the GSOTxxC can also be used in parallel in order to “double” the performance.

This offers:

- double surge power = double peak pulse current ( $2 \times I_{PPM}$ )
- half of the line inductance = reduced clamping voltage
- half of the line resistance = reduced clamping voltage
- double line capacitance ( $2 \times C_D$ )
- double reverse leakage current ( $2 \times I_R$ )

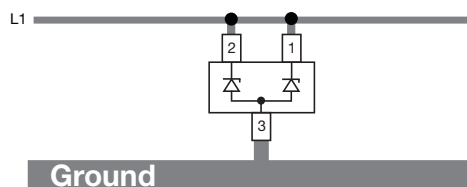

20359

| ELECTRICAL CHARACTERISTICS GSOT03C ( $T_{amb} = 25^\circ\text{C}$ unless otherwise specified) |   |               |      |      |      |               |
|---|---|---------------|------|------|------|---------------|
| between pin 1 to pin 3 or pin 2 to pin 3  |   |               |      |      |      |               |
| PARAMETER   | TEST CONDITIONS/REMARKS                     | SYMBOL        | MIN. | TYP. | MAX. | UNIT          |
| Protection paths  | Number of lines which can be protected      | $N_{channel}$ | -    | -    | 2    | lines         |
| Reverse stand-off voltage   | Max. reverse working voltage                | $V_{RWM}$     | -    | -    | 3.3  | V             |
| Reverse voltage   | at $I_R = 100 \mu\text{A}$                  | $V_R$         | 3.3  | -    | -    | V             |
| Reverse current   | at $V_R = 3.3 \text{ V}$                    | $I_R$         | -    | -    | 100  | $\mu\text{A}$ |
| Reverse breakdown voltage   | at $I_R = 1 \text{ mA}$                     | $V_{BR}$      | 4.0  | 4.6  | 5.5  | V             |
| Reverse clamping voltage  | at $I_{PP} = 1 \text{ A}$                   | $V_C$         | -    | 5.7  | 7.5  | V             |
|   | at $I_{PP} = I_{PPM} = 30 \text{ A}$        |               | -    | 10   | 12.3 | V             |
| Forward clamping voltage  | at $I_{PP} = 1 \text{ A}$                   | $V_F$         | -    | 1    | 1.2  | V             |
|   | at $I_{PP} = I_{PPM} = 30 \text{ A}$        |               | -    | 4.5  | -    | V             |
| Capacitance   | at $V_R = 0 \text{ V}; f = 1 \text{ MHz}$   | $C_D$         | -    | 420  | 600  | pF            |
|   | at $V_R = 1.6 \text{ V}; f = 1 \text{ MHz}$ |               | -    | 260  | -    | pF            |



| <b>ELECTRICAL CHARACTERISTICS GSOT04C</b> ( $T_{amb} = 25\text{ }^{\circ}\text{C}$ unless otherwise specified)<br>between pin 1 to pin 3 or pin 2 to pin 3 |  |               |      |      |      |               |
|--|--|---------------|------|------|------|---------------|
| PARAMETER  | TEST CONDITIONS/REMARKS                    | SYMBOL        | MIN. | TYP. | MAX. | UNIT          |
| Protection paths   | Number of lines which can be protected     | $N_{channel}$ | -    | -    | 2    | lines         |
| Reverse stand-off voltage  | Max. reverse working voltage               | $V_{RWM}$     | -    | -    | 4    | V             |
| Reverse voltage  | at $I_R = 20\text{ }\mu\text{A}$           | $V_R$         | 4    | -    | -    | V             |
| Reverse current  | at $V_R = 4\text{ V}$                      | $I_R$         | -    | -    | 20   | $\mu\text{A}$ |
| Reverse breakdown voltage  | at $I_R = 1\text{ mA}$                     | $V_{BR}$      | 5    | 6.1  | 7    | V             |
| Reverse clamping voltage   | at $I_{PP} = 1\text{ A}$                   | $V_C$         | -    | 7.5  | 9    | V             |
|  | at $I_{PP} = I_{PPM} = 30\text{ A}$        |               | -    | 11.2 | 14.3 | V             |
| Forward clamping voltage   | at $I_{PP} = 1\text{ A}$                   | $V_F$         | -    | 1    | 1.2  | V             |
|  | at $I_{PP} = I_{PPM} = 30\text{ A}$        |               | -    | 4.5  | -    | V             |
| Capacitance  | at $V_R = 0\text{ V}$ ; $f = 1\text{ MHz}$ | $C_D$         | -    | 310  | 450  | pF            |
|  | at $V_R = 2\text{ V}$ ; $f = 1\text{ MHz}$ |               | -    | 200  | -    | pF            |

| <b>ELECTRICAL CHARACTERISTICS GSOT05C</b> ( $T_{amb} = 25\text{ }^{\circ}\text{C}$ unless otherwise specified)<br>between pin 1 to pin 3 or pin 2 to pin 3 |  |               |      |      |      |               |
|--|--|---------------|------|------|------|---------------|
| PARAMETER  | TEST CONDITIONS/REMARKS                      | SYMBOL        | MIN. | TYP. | MAX. | UNIT          |
| Protection paths   | Number of lines which can be protected       | $N_{channel}$ | -    | -    | 2    | lines         |
| Reverse stand-off voltage  | Max. reverse working voltage                 | $V_{RWM}$     | -    | -    | 5    | V             |
| Reverse voltage  | at $I_R = 10\text{ }\mu\text{A}$             | $V_R$         | 5    | -    | -    | V             |
| Reverse current  | at $V_R = 5\text{ V}$                        | $I_R$         | -    | -    | 10   | $\mu\text{A}$ |
| Reverse breakdown voltage  | at $I_R = 1\text{ mA}$                       | $V_{BR}$      | 6    | 6.8  | 8    | V             |
| Reverse clamping voltage   | at $I_{PP} = 1\text{ A}$                     | $V_C$         | -    | 7    | 8.7  | V             |
|  | at $I_{PP} = I_{PPM} = 30\text{ A}$          |               | -    | 12   | 16   | V             |
| Forward clamping voltage   | at $I_{PP} = 1\text{ A}$                     | $V_F$         | -    | 1    | 1.2  | V             |
|  | at $I_{PP} = I_{PPM} = 30\text{ A}$          |               | -    | 4.5  | -    | V             |
| Capacitance  | at $V_R = 0\text{ V}$ ; $f = 1\text{ MHz}$   | $C_D$         | -    | 260  | 350  | pF            |
|  | at $V_R = 2.5\text{ V}$ ; $f = 1\text{ MHz}$ |               | -    | 150  | -    | pF            |

| <b>ELECTRICAL CHARACTERISTICS GSOT08C</b> ( $T_{amb} = 25\text{ }^{\circ}\text{C}$ unless otherwise specified)<br>between pin 1 to pin 3 or pin 2 to pin 3 |  |               |      |      |      |               |
|--|--|---------------|------|------|------|---------------|
| PARAMETER  | TEST CONDITIONS/REMARKS                    | SYMBOL        | MIN. | TYP. | MAX. | UNIT          |
| Protection paths   | Number of lines which can be protected     | $N_{channel}$ | -    | -    | 2    | lines         |
| Reverse stand-off voltage  | Max. reverse working voltage               | $V_{RWM}$     | -    | -    | 8    | V             |
| Reverse voltage  | at $I_R = 5\text{ }\mu\text{A}$            | $V_R$         | 8    | -    | -    | V             |
| Reverse current  | at $V_R = 8\text{ V}$                      | $I_R$         | -    | -    | 5    | $\mu\text{A}$ |
| Reverse breakdown voltage  | at $I_R = 1\text{ mA}$                     | $V_{BR}$      | 9    | 10   | 11   | V             |
| Reverse clamping voltage   | at $I_{PP} = 1\text{ A}$                   | $V_C$         | -    | 10.7 | 13   | V             |
|  | at $I_{PP} = I_{PPM} = 18\text{ A}$        |               | -    | 15.2 | 19.2 | V             |
| Forward clamping voltage   | at $I_{PP} = 1\text{ A}$                   | $V_F$         | -    | 1    | 1.2  | V             |
|  | at $I_{PP} = I_{PPM} = 18\text{ A}$        |               | -    | 3    | -    | V             |
| Capacitance  | at $V_R = 0\text{ V}$ ; $f = 1\text{ MHz}$ | $C_D$         | -    | 160  | 250  | pF            |
|  | at $V_R = 4\text{ V}$ ; $f = 1\text{ MHz}$ |               | -    | 80   | -    | pF            |



| <b>ELECTRICAL CHARACTERISTICS GSOT12C</b> ( $T_{amb} = 25\text{ }^{\circ}\text{C}$ unless otherwise specified)<br>between pin 1 to pin 3 or pin 2 to pin 3 |  |               |      |      |      |               |
|--|--|---------------|------|------|------|---------------|
| PARAMETER  | TEST CONDITIONS/REMARKS                    | SYMBOL        | MIN. | TYP. | MAX. | UNIT          |
| Protection paths   | Number of lines which can be protected     | $N_{channel}$ | -    | -    | 2    | lines         |
| Reverse stand-off voltage  | Max. reverse working voltage               | $V_{RWM}$     | -    | -    | 12   | V             |
| Reverse voltage  | at $I_R = 1\text{ }\mu\text{A}$            | $V_R$         | 12   | -    | -    | V             |
| Reverse current  | at $V_R = 12\text{ V}$                     | $I_R$         | -    | -    | 1    | $\mu\text{A}$ |
| Reverse breakdown voltage  | at $I_R = 1\text{ mA}$                     | $V_{BR}$      | 13.5 | 15   | 16.5 | V             |
| Reverse clamping voltage   | at $I_{PP} = 1\text{ A}$                   | $V_C$         | -    | 15.4 | 18.7 | V             |
|  | at $I_{PP} = I_{PPM} = 12\text{ A}$        |               | -    | 21.2 | 26   | V             |
| Forward clamping voltage   | at $I_{PP} = 1\text{ A}$                   | $V_F$         | -    | 1    | 1.2  | V             |
|  | at $I_{PP} = I_{PPM} = 12\text{ A}$        |               | -    | 2.2  | -    | V             |
| Capacitance  | at $V_R = 0\text{ V}$ ; $f = 1\text{ MHz}$ | $C_D$         | -    | 115  | 150  | pF            |
|  | at $V_R = 6\text{ V}$ ; $f = 1\text{ MHz}$ |               | -    | 50   | -    | pF            |

| <b>ELECTRICAL CHARACTERISTICS GSOT15C</b> ( $T_{amb} = 25\text{ }^{\circ}\text{C}$ unless otherwise specified)<br>between pin 1 to pin 3 or pin 2 to pin 3 |  |               |      |      |      |               |
|--|--|---------------|------|------|------|---------------|
| PARAMETER  | TEST CONDITIONS/REMARKS                      | SYMBOL        | MIN. | TYP. | MAX. | UNIT          |
| Protection paths   | Number of lines which can be protected       | $N_{channel}$ | -    | -    | 2    | lines         |
| Reverse stand-off voltage  | Max. reverse working voltage                 | $V_{RWM}$     | -    | -    | 15   | V             |
| Reverse voltage  | at $I_R = 1\text{ }\mu\text{A}$              | $V_R$         | 15   | -    | -    | V             |
| Reverse current  | at $V_R = 15\text{ V}$                       | $I_R$         | -    | -    | 1    | $\mu\text{A}$ |
| Reverse breakdown voltage  | at $I_R = 1\text{ mA}$                       | $V_{BR}$      | 16.5 | 18   | 20   | V             |
| Reverse clamping voltage   | at $I_{PP} = 1\text{ A}$                     | $V_C$         | -    | 19.4 | 23.5 | V             |
|  | at $I_{PP} = I_{PPM} = 8\text{ A}$           |               | -    | 24.8 | 28.8 | V             |
| Forward clamping voltage   | at $I_{PP} = 1\text{ A}$                     | $V_F$         | -    | 1    | 1.2  | V             |
|  | at $I_{PP} = I_{PPM} = 8\text{ A}$           |               | -    | 1.8  | -    | V             |
| Capacitance  | at $V_R = 0\text{ V}$ ; $f = 1\text{ MHz}$   | $C_D$         | -    | 90   | 120  | pF            |
|  | at $V_R = 7.5\text{ V}$ ; $f = 1\text{ MHz}$ |               | -    | 35   | -    | pF            |

| <b>ELECTRICAL CHARACTERISTICS GSOT24C</b> ( $T_{amb} = 25\text{ }^{\circ}\text{C}$ unless otherwise specified)<br>between pin 1 to pin 3 or pin 2 to pin 3 |   |               |      |      |      |               |
|--|---|---------------|------|------|------|---------------|
| PARAMETER  | TEST CONDITIONS/REMARKS                     | SYMBOL        | MIN. | TYP. | MAX. | UNIT          |
| Protection paths   | Number of lines which can be protected      | $N_{channel}$ | -    | -    | 2    | lines         |
| Reverse stand-off voltage  | Max. reverse working voltage                | $V_{RWM}$     | -    | -    | 24   | V             |
| Reverse voltage  | at $I_R = 1\text{ }\mu\text{A}$             | $V_R$         | 24   | -    | -    | V             |
| Reverse current  | at $V_R = 24\text{ V}$                      | $I_R$         | -    | -    | 1    | $\mu\text{A}$ |
| Reverse breakdown voltage  | at $I_R = 1\text{ mA}$                      | $V_{BR}$      | 27   | 30   | 33   | V             |
| Reverse clamping voltage   | at $I_{PP} = 1\text{ A}$                    | $V_C$         | -    | 34   | 41   | V             |
|  | at $I_{PP} = I_{PPM} = 5\text{ A}$          |               | -    | 41   | 47   | V             |
| Forward clamping voltage   | at $I_{PP} = 1\text{ A}$                    | $V_F$         | -    | 1    | 1.2  | V             |
|  | at $I_{PP} = I_{PPM} = 5\text{ A}$          |               | -    | 1.4  | -    | V             |
| Capacitance  | at $V_R = 0\text{ V}$ ; $f = 1\text{ MHz}$  | $C_D$         | -    | 65   | 80   | pF            |
|  | at $V_R = 12\text{ V}$ ; $f = 1\text{ MHz}$ |               | -    | 20   | -    | pF            |

| <b>ELECTRICAL CHARACTERISTICS GSOT36C</b> ( $T_{amb} = 25\text{ }^{\circ}\text{C}$ unless otherwise specified)<br>between pin 1 to pin 3 or pin 2 to pin 3 |   |               |      |      |      |               |
|--|---|---------------|------|------|------|---------------|
| PARAMETER  | TEST CONDITIONS/REMARKS                     | SYMBOL        | MIN. | TYP. | MAX. | UNIT          |
| Protection paths   | Number of lines which can be protected      | $N_{channel}$ | -    | -    | 2    | lines         |
| Reverse stand-off voltage  | Max. reverse working voltage                | $V_{RWM}$     | -    | -    | 36   | V             |
| Reverse voltage  | at $I_R = 1\text{ }\mu\text{A}$             | $V_R$         | 36   | -    | -    | V             |
| Reverse current  | at $V_R = 36\text{ V}$                      | $I_R$         | -    | -    | 1    | $\mu\text{A}$ |
| Reverse breakdown voltage  | at $I_R = 1\text{ mA}$                      | $V_{BR}$      | 39   | 43   | 47   | V             |
| Reverse clamping voltage   | at $I_{PP} = 1\text{ A}$                    | $V_C$         | -    | 49   | 60   | V             |
|  | at $I_{PP} = I_{PPM} = 3.5\text{ A}$        |               | -    | 59   | 71   | V             |
| Forward clamping voltage   | at $I_{PP} = 1\text{ A}$                    | $V_F$         | -    | 1    | 1.2  | V             |
|  | at $I_{PP} = I_{PPM} = 3.5\text{ A}$        |               | -    | 1.3  | -    | V             |
| Capacitance  | at $V_R = 0\text{ V}$ ; $f = 1\text{ MHz}$  | $C_D$         | -    | 52   | 65   | pF            |
|  | at $V_R = 18\text{ V}$ ; $f = 1\text{ MHz}$ |               | -    | 12   | -    | pF            |

**BiSy-MODE** (1-line bidirectional symmetrical protection mode)

If a bipolar symmetrical protection device is needed the GSOTxxC can also be used as a single line protection device. Therefore pin 1 has to be connected to the signal- or data-line (L1) and pin 2 to ground (or vice versa). Pin 3 must not be connected. Positive and negative voltage transients will be clamped in the same way. The clamping current through the GSOTxxC passes one diode in forward direction and the other one in reverse direction. The clamping voltage ( $V_C$ ) is defined by the breakthrough voltage ( $V_{BR}$ ) level of one diode plus the forward voltage of the other diode plus the voltage drop at the series impedances (resistances and inductances) of the protection device.

Due to the same clamping levels in positive and negative direction the GSOTxxC voltage clamping behaviour is bidirectional and symmetrical (BiSy).

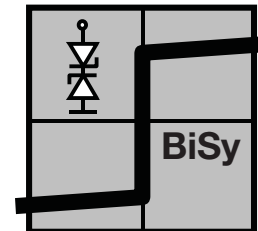

20361

| <b>ELECTRICAL CHARACTERISTICS GSOT03C</b> ( $T_{amb} = 25\text{ }^{\circ}\text{C}$ unless otherwise specified)<br>between pin 1 to pin 2 or pin 2 to pin1; pin 3 not connected |  |               |      |      |      |               |
|--|--|---------------|------|------|------|---------------|
| PARAMETER  | TEST CONDITIONS/REMARKS                      | SYMBOL        | MIN. | TYP. | MAX. | UNIT          |
| Protection paths   | Number of lines which can be protected       | $N_{channel}$ | -    | -    | 1    | lines         |
| Reverse stand-off voltage  | Max. reverse working voltage                 | $V_{RWM}$     | -    | -    | 3.8  | V             |
| Reverse voltage  | at $I_R = 100\text{ }\mu\text{A}$            | $V_R$         | 3.8  | -    | -    | V             |
| Reverse current  | at $V_R = 3.8\text{ V}$                      | $I_R$         | -    | -    | 100  | $\mu\text{A}$ |
| Reverse breakdown voltage  | at $I_R = 1\text{ mA}$                       | $V_{BR}$      | 4.5  | 5.3  | 6.2  | V             |
| Reverse clamping voltage   | at $I_{PP} = 1\text{ A}$                     | $V_C$         | -    | 7    | 8.4  | V             |
|  | at $I_{PP} = I_{PPM} = 30\text{ A}$          |               | -    | 14   | 16.8 | V             |
| Capacitance  | at $V_R = 0\text{ V}$ ; $f = 1\text{ MHz}$   | $C_D$         | -    | 210  | 300  | pF            |
|  | at $V_R = 1.6\text{ V}$ ; $f = 1\text{ MHz}$ |               | -    | 190  | -    | pF            |





| <b>ELECTRICAL CHARACTERISTICS GSOT04C</b> ( $T_{amb} = 25\text{ }^{\circ}\text{C}$ unless otherwise specified)<br>between pin 1 to pin 2 or pin 2 to pin1; pin 3 not connected |  |               |      |      |      |               |
|--|--|---------------|------|------|------|---------------|
| PARAMETER  | TEST CONDITIONS/REMARKS                    | SYMBOL        | MIN. | TYP. | MAX. | UNIT          |
| Protection paths   | Number of lines which can be protected     | $N_{channel}$ | -    | -    | 1    | lines         |
| Reverse stand-off voltage  | Max. reverse working voltage               | $V_{RWM}$     | -    | -    | 4.5  | V             |
| Reverse voltage  | at $I_R = 20\text{ }\mu\text{A}$           | $V_R$         | 4.5  | -    | -    | V             |
| Reverse current  | at $V_R = 4.5\text{ V}$                    | $I_R$         | -    | -    | 20   | $\mu\text{A}$ |
| Reverse breakdown voltage  | at $I_R = 1\text{ mA}$                     | $V_{BR}$      | 5.5  | 6.8  | 7.7  | V             |
| Reverse clamping voltage   | at $I_{PP} = 1\text{ A}$                   | $V_C$         | -    | 7.5  | 9    | V             |
|  | at $I_{PP} = I_{PPM} = 30\text{ A}$        |               | -    | 15.7 | 18.8 | V             |
| Capacitance  | at $V_R = 0\text{ V}$ ; $f = 1\text{ MHz}$ | $C_D$         | -    | 155  | 225  | pF            |
|  | at $V_R = 2\text{ V}$ ; $f = 1\text{ MHz}$ |               | -    | 135  | -    | pF            |

| <b>ELECTRICAL CHARACTERISTICS GSOT05C</b> ( $T_{amb} = 25\text{ }^{\circ}\text{C}$ unless otherwise specified)<br>between pin 1 to pin 2 or pin 2 to pin1; pin 3 not connected |  |               |      |      |      |               |
|--|--|---------------|------|------|------|---------------|
| PARAMETER  | TEST CONDITIONS/REMARKS                    | SYMBOL        | MIN. | TYP. | MAX. | UNIT          |
| Protection paths   | Number of lines which can be protected     | $N_{channel}$ | -    | -    | 1    | lines         |
| Reverse stand-off voltage  | Max. reverse working voltage               | $V_{RWM}$     | -    | -    | 5.5  | V             |
| Reverse voltage  | at $I_R = 10\text{ }\mu\text{A}$           | $V_R$         | 5.5  | -    | -    | V             |
| Reverse current  | at $V_R = 5.5\text{ V}$                    | $I_R$         | -    | -    | 10   | $\mu\text{A}$ |
| Reverse breakdown voltage  | at $I_R = 1\text{ mA}$                     | $V_{BR}$      | 6.5  | 7.5  | 8.7  | V             |
| Reverse clamping voltage   | at $I_{PP} = 1\text{ A}$                   | $V_C$         | -    | 8.1  | 9.7  | V             |
|  | at $I_{PP} = I_{PPM} = 30\text{ A}$        |               | -    | 17   | 20.4 | V             |
| Capacitance  | at $V_R = 0\text{ V}$ ; $f = 1\text{ MHz}$ | $C_D$         | -    | 130  | 175  | pF            |
|  | at $V_R = 4\text{ V}$ ; $f = 1\text{ MHz}$ |               | -    | 100  | -    | pF            |

| <b>ELECTRICAL CHARACTERISTICS GSOT08C</b> ( $T_{amb} = 25\text{ }^{\circ}\text{C}$ unless otherwise specified)<br>between pin 1 to pin 2 or pin 2 to pin1; pin 3 not connected |  |               |      |      |      |               |
|--|--|---------------|------|------|------|---------------|
| PARAMETER  | TEST CONDITIONS/REMARKS                    | SYMBOL        | MIN. | TYP. | MAX. | UNIT          |
| Protection paths   | Number of lines which can be protected     | $N_{channel}$ | -    | -    | 1    | lines         |
| Reverse stand-off voltage  | Max. reverse working voltage               | $V_{RWM}$     | -    | -    | 8.5  | V             |
| Reverse voltage  | at $I_R = 5\text{ }\mu\text{A}$            | $V_R$         | 8.5  | -    | -    | V             |
| Reverse current  | at $V_R = 8.5\text{ V}$                    | $I_R$         | -    | -    | 5    | $\mu\text{A}$ |
| Reverse breakdown voltage  | at $I_R = 1\text{ mA}$                     | $V_{BR}$      | 9.5  | 10.7 | 11.7 | V             |
| Reverse clamping voltage   | at $I_{PP} = 1\text{ A}$                   | $V_C$         | -    | 11.7 | 14   | V             |
|  | at $I_{PP} = I_{PPM} = 18\text{ A}$        |               | -    | 18.5 | 22.2 | V             |
| Capacitance  | at $V_R = 0\text{ V}$ ; $f = 1\text{ MHz}$ | $C_D$         | -    | 80   | 125  | pF            |
|  | at $V_R = 4\text{ V}$ ; $f = 1\text{ MHz}$ |               | -    | 60   | -    | pF            |

| <b>ELECTRICAL CHARACTERISTICS GSOT12C</b> ( $T_{amb} = 25\text{ }^{\circ}\text{C}$ unless otherwise specified)<br>between pin 1 to pin 2 or pin 2 to pin1; pin 3 not connected |  |               |      |      |      |               |
|--|--|---------------|------|------|------|---------------|
| PARAMETER  | TEST CONDITIONS/REMARKS                      | SYMBOL        | MIN. | TYP. | MAX. | UNIT          |
| Protection paths   | Number of lines which can be protected       | $N_{channel}$ | -    | -    | 1    | lines         |
| Reverse stand-off voltage  | Max. reverse working voltage                 | $V_{RWM}$     | -    | -    | 12.5 | V             |
| Reverse voltage  | at $I_R = 1\text{ }\mu\text{A}$              | $V_R$         | 12.5 | -    | -    | V             |
| Reverse current  | at $V_R = 12.5\text{ V}$                     | $I_R$         | -    | -    | 1    | $\mu\text{A}$ |
| Reverse breakdown voltage  | at $I_R = 1\text{ mA}$                       | $V_{BR}$      | 13.5 | 15.7 | 16.5 | V             |
| Reverse clamping voltage   | at $I_{PP} = 1\text{ A}$                     | $V_C$         | -    | 16.4 | 19.7 | V             |
|  | at $I_{PP} = I_{PPM} = 12\text{ A}$          |               | -    | 23.4 | 28.1 | V             |
| Capacitance  | at $V_R = 0\text{ V}$ ; $f = 1\text{ MHz}$   | $C_D$         | -    | 58   | 75   | pF            |
|  | at $V_R = 7.5\text{ V}$ ; $f = 1\text{ MHz}$ |               | -    | 36   | -    | pF            |



| <b>ELECTRICAL CHARACTERISTICS GSOT15C</b> ( $T_{amb} = 25\text{ }^{\circ}\text{C}$ unless otherwise specified)<br>between pin 1 to pin 2 or pin 2 to pin1; pin 3 not connected |  |               |      |      |      |               |
|--|--|---------------|------|------|------|---------------|
| PARAMETER  | TEST CONDITIONS/REMARKS                      | SYMBOL        | MIN. | TYP. | MAX. | UNIT          |
| Protection paths   | Number of lines which can be protected       | $N_{channel}$ | -    | -    | 1    | lines         |
| Reverse stand-off voltage  | Max. reverse working voltage                 | $V_{RWM}$     | -    | -    | 15.5 | V             |
| Reverse voltage  | at $I_R = 1\text{ }\mu\text{A}$              | $V_R$         | 15.5 | -    | -    | V             |
| Reverse current  | at $V_R = 15.5\text{ V}$                     | $I_R$         | -    | -    | 1    | $\mu\text{A}$ |
| Reverse breakdown voltage  | at $I_R = 1\text{ mA}$                       | $V_{BR}$      | 17   | 18.7 | 20.7 | V             |
| Reverse clamping voltage   | at $I_{PP} = 1\text{ A}$                     | $V_C$         | -    | 20.4 | 24.5 | V             |
|  | at $I_{PP} = I_{PPM} = 8\text{ A}$           |               | -    | 26.6 | 30.6 | V             |
| Capacitance  | at $V_R = 0\text{ V}$ ; $f = 1\text{ MHz}$   | $C_D$         | -    | 45   | 60   | pF            |
|  | at $V_R = 7.5\text{ V}$ ; $f = 1\text{ MHz}$ |               | -    | 25   | -    | pF            |

| <b>ELECTRICAL CHARACTERISTICS GSOT24C</b> ( $T_{amb} = 25\text{ }^{\circ}\text{C}$ unless otherwise specified)<br>between pin 1 to pin 2 or pin 2 to pin1; pin 3 not connected |   |               |      |      |      |               |
|--|---|---------------|------|------|------|---------------|
| PARAMETER  | TEST CONDITIONS/REMARKS                     | SYMBOL        | MIN. | TYP. | MAX. | UNIT          |
| Protection paths   | Number of lines which can be protected      | $N_{channel}$ | -    | -    | 1    | lines         |
| Reverse stand-off voltage  | Max. reverse working voltage                | $V_{RWM}$     | -    | -    | 24.5 | V             |
| Reverse voltage  | at $I_R = 1\text{ }\mu\text{A}$             | $V_R$         | 24.5 | -    | -    | V             |
| Reverse current  | at $V_R = 24.5\text{ V}$                    | $I_R$         | -    | -    | 1    | $\mu\text{A}$ |
| Reverse breakdown voltage  | at $I_R = 1\text{ mA}$                      | $V_{BR}$      | 27.5 | 30.7 | 33.7 | V             |
| Reverse clamping voltage   | at $I_{PP} = 1\text{ A}$                    | $V_C$         | -    | 34   | 41   | V             |
|  | at $I_{PP} = I_{PPM} = 5\text{ A}$          |               | -    | 40   | 48   | V             |
| Capacitance  | at $V_R = 0\text{ V}$ ; $f = 1\text{ MHz}$  | $C_D$         | -    | 33   | 40   | pF            |
|  | at $V_R = 12\text{ V}$ ; $f = 1\text{ MHz}$ |               | -    | 18   | -    | pF            |

| <b>ELECTRICAL CHARACTERISTICS GSOT36C</b> ( $T_{amb} = 25\text{ }^{\circ}\text{C}$ unless otherwise specified)<br>between pin 1 to pin 2 or pin 2 to pin1; pin 3 not connected |   |               |      |      |      |               |
|--|---|---------------|------|------|------|---------------|
| PARAMETER  | TEST CONDITIONS/REMARKS                     | SYMBOL        | MIN. | TYP. | MAX. | UNIT          |
| Protection paths   | Number of lines which can be protected      | $N_{channel}$ | -    | -    | 1    | lines         |
| Reverse stand-off voltage  | Max. reverse working voltage                | $V_{RWM}$     | -    | -    | 36.5 | V             |
| Reverse voltage  | at $I_R = 1\text{ }\mu\text{A}$             | $V_R$         | 36.5 | -    | -    | V             |
| Reverse current  | at $V_R = 36.5\text{ V}$                    | $I_R$         | -    | -    | 1    | $\mu\text{A}$ |
| Reverse breakdown voltage  | at $I_R = 1\text{ mA}$                      | $V_{BR}$      | 39.5 | 43.7 | 47.7 | V             |
| Reverse clamping voltage   | at $I_{PP} = 1\text{ A}$                    | $V_C$         | -    | 50   | 60   | V             |
|  | at $I_{PP} = I_{PPM} = 3.5\text{ A}$        |               | -    | 60   | 72   | V             |
| Capacitance  | at $V_R = 0\text{ V}$ ; $f = 1\text{ MHz}$  | $C_D$         | -    | 26   | 33   | pF            |
|  | at $V_R = 18\text{ V}$ ; $f = 1\text{ MHz}$ |               | -    | 10   | -    | pF            |

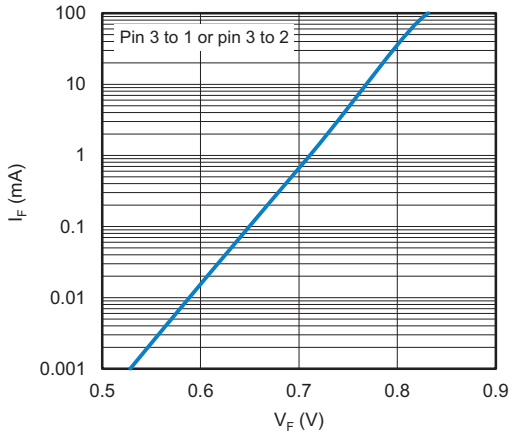

Fig. 1 - Typical Forward Current  $I_F$  vs. Forward Voltage  $V_F$

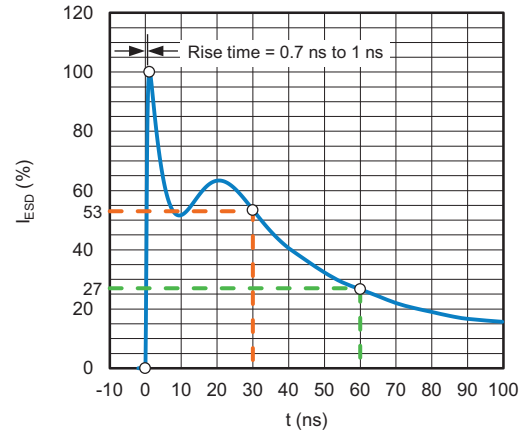

Fig. 4 - ESD Discharge Current Waveform According to IEC 61000-4-2 (330  $\Omega$  / 150 pF)

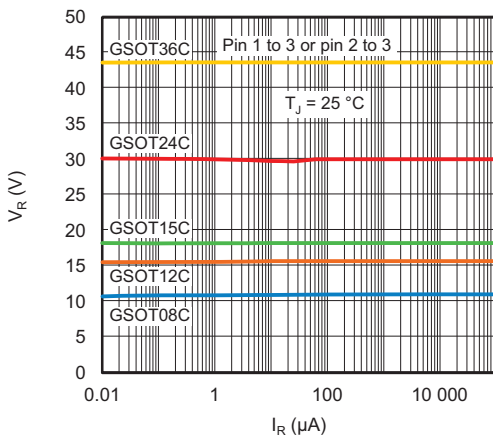

Fig. 2 - Typical Reverse Voltage  $V_R$  vs. Reverse Current  $I_R$

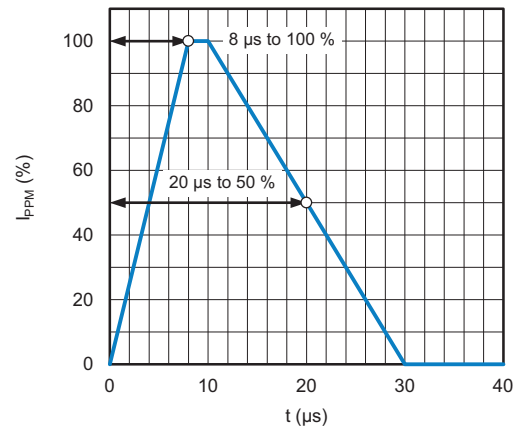

Fig. 5 - 8/20  $\mu$ s Peak Pulse Current Waveform According to IEC 61000-4-5

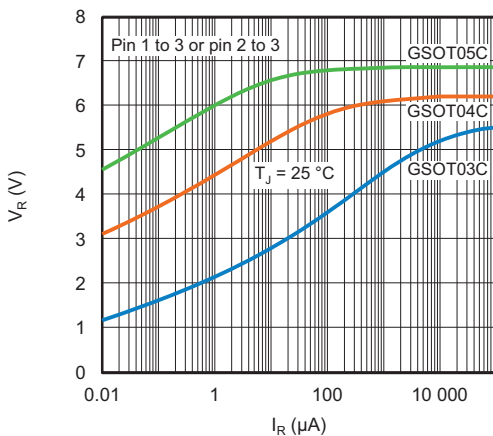

Fig. 3 - Typical Reverse Voltage  $V_R$  vs. Reverse Current  $I_R$

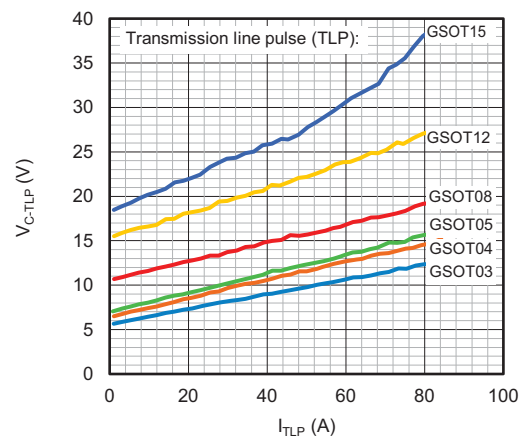

Fig. 6 - Typical Clamping Voltage vs. Peak Pulse Current

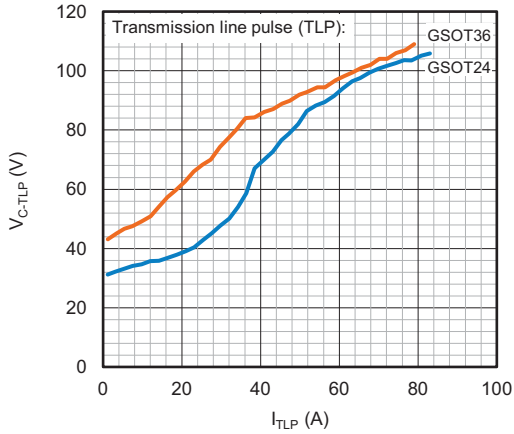

Fig. 7 - Typical Clamping Voltage vs. Peak Pulse Current

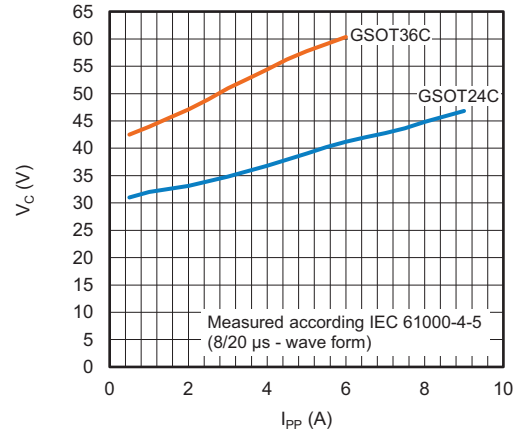

Fig. 9 - Typical Peak Clamping Voltage vs. Peak Pulse Current

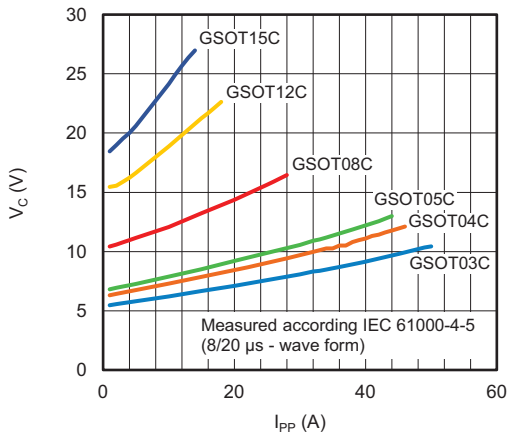

Fig. 8 - Typical Peak Clamping Voltage vs. Peak Pulse Current

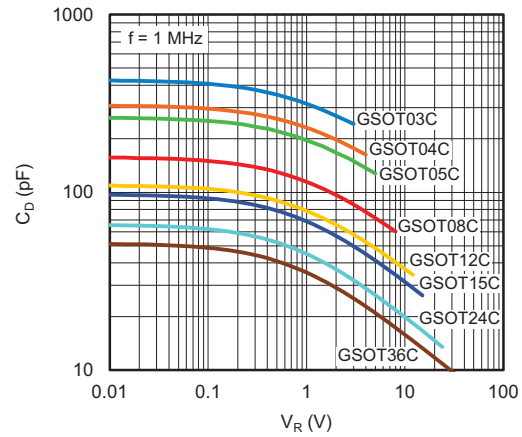
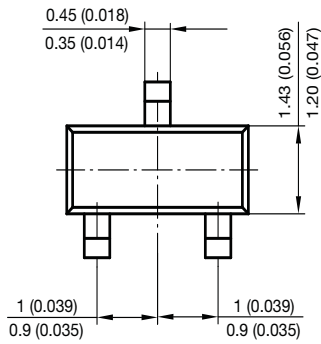
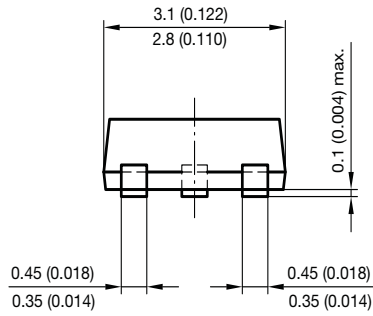

Fig. 10 - Typical Capacitance vs. Reverse Voltage



### PACKAGE DIMENSIONS in millimeters (inches): SOT-23



Foot print recommendation:

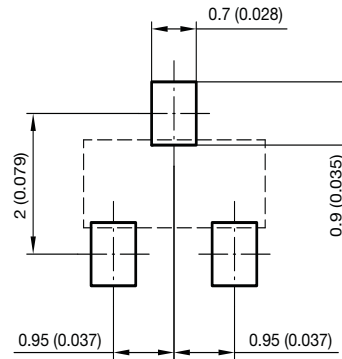

Document no.: 6.541-5014.01-4  
 Rev. 8 - Date: 23. Sep. 2009  
 17418

Orientation in carrier tape  
 SOT-23  
 S8-V-3929.01-006 (4)  
 04.02.2010  
 22607





## Disclaimer

ALL PRODUCT, PRODUCT SPECIFICATIONS AND DATA ARE SUBJECT TO CHANGE WITHOUT NOTICE TO IMPROVE RELIABILITY, FUNCTION OR DESIGN OR OTHERWISE.

Vishay Intertechnology, Inc., its affiliates, agents, and employees, and all persons acting on its or their behalf (collectively, "Vishay"), disclaim any and all liability for any errors, inaccuracies or incompleteness contained in any datasheet or in any other disclosure relating to any product.

Vishay makes no warranty, representation or guarantee regarding the suitability of the products for any particular purpose or the continuing production of any product. To the maximum extent permitted by applicable law, Vishay disclaims (i) any and all liability arising out of the application or use of any product, (ii) any and all liability, including without limitation special, consequential or incidental damages, and (iii) any and all implied warranties, including warranties of fitness for particular purpose, non-infringement and merchantability.

Statements regarding the suitability of products for certain types of applications are based on Vishay's knowledge of typical requirements that are often placed on Vishay products in generic applications. Such statements are not binding statements about the suitability of products for a particular application. It is the customer's responsibility to validate that a particular product with the properties described in the product specification is suitable for use in a particular application. Parameters provided in datasheets and / or specifications may vary in different applications and performance may vary over time. All operating parameters, including typical parameters, must be validated for each customer application by the customer's technical experts. Product specifications do not expand or otherwise modify Vishay's terms and conditions of purchase, including but not limited to the warranty expressed therein.

Hyperlinks included in this datasheet may direct users to third-party websites. These links are provided as a convenience and for informational purposes only. Inclusion of these hyperlinks does not constitute an endorsement or an approval by Vishay of any of the products, services or opinions of the corporation, organization or individual associated with the third-party website. Vishay disclaims any and all liability and bears no responsibility for the accuracy, legality or content of the third-party website or for that of subsequent links.

Except as expressly indicated in writing, Vishay products are not designed for use in medical, life-saving, or life-sustaining applications or for any other application in which the failure of the Vishay product could result in personal injury or death. Customers using or selling Vishay products not expressly indicated for use in such applications do so at their own risk. Please contact authorized Vishay personnel to obtain written terms and conditions regarding products designed for such applications.

No license, express or implied, by estoppel or otherwise, to any intellectual property rights is granted by this document or by any conduct of Vishay. Product names and markings noted herein may be trademarks of their respective owners.