

Product Description

Qorvo's TGA2625-CP is a packaged high-power X-Band amplifier fabricated on Qorvo's QGaN25 0.25 μm GaN on SiC process. Operating from 10 to 11 GHz, the TGA2625-CP achieves 42.5 dBm saturated output power, a power-added efficiency of $> 40\%$, and power gain of 28 dB.

The TGA2625-CP is packaged in a 10-lead 15x15 mm bolt-down package with a Cu base for superior thermal management. It can support a range of bias voltages and performs well under CW and pulsed conditions. Both RF ports are internally DC blocked and matched to 50 ohms allowing for simple system integration.

The TGA2625-CP is ideally suited for both commercial and defense applications.

Lead free and RoHS compliant.

Evaluation Boards are available upon request.

Functional Block Diagram

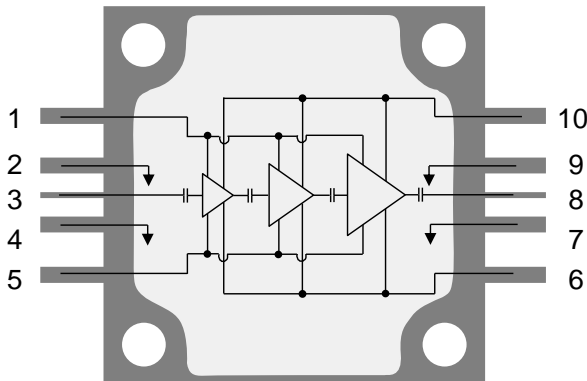

Product Features

- Frequency Range: 10 – 11 GHz
- Pout: 42.5 dBm (at $P_{IN} = 15$ dBm)
- PAE: $> 40\%$
- Power Gain: 28 dB (at $P_{IN} = 15$ dBm)
- Bias: $V_D = 28$ V, $I_{DQ} = 365$ mA, $V_G = -2.6$ V typical, pulsed ($PW = 100$ μs , $DC = 10\%$)
- Package Dimensions: 15.2 x 15.2 x 3.5 mm
- Package base is pure Cu offering superior thermal management

Applications

- Radar
- Communications

Ordering Information

Part No.	Description
TGA2625-CP	10 – 11 GHz 20 W GaN Power Amplifier

Absolute Maximum Ratings

Parameter	Value / Range
Drain Voltage (V_D)	40 V
Gate Voltage Range (V_G)	-8 to 0 V
Drain Current (I_D)	3 A
Gate Current (I_G)	-6 to 14 ⁽¹⁾ mA
Power Dissipation (P_{DISS}), 85 °C	53 W
Input Power, CW, 50 Ω , (P_{IN})	21 dBm
Input Power, CW, VSWR 6:1, $V_D = 28$ V, 85 °C, (P_{IN})	21 dBm
Mounting Temperature (30 Seconds)	260 °C
Storage Temperature	-55 to 150 °C

Operation of this device outside the parameter ranges given above may cause permanent damage. These are stress ratings only, and functional operation of the device at these conditions is not implied.

(1) Max rating for IG is at Channel Temperature (TCH) of 200 °C.

Recommended Operating Conditions

Parameter	Value / Range
Drain Voltage (V_D) pulsed: PW = 100 μ s, DC = 10 %	28 V
Drain Current (I_{DQ})	365 mA
Drain Current Under RF Drive (I_{D_DRIVE})	See plots p. 6
Gate Voltage (V_G)	-2.6 V (Typ.)
Gate Current Under RF Drive (I_{G_DRIVE})	See plots p. 6
Temperature (T_{BASE})	-40 to 85 °C

Electrical specifications are measured at specified test conditions. Specifications are not guaranteed over all recommended operating conditions.

Electrical Specifications

Parameter	Min	Typ	Max	Units
Operational Frequency Range	10		11	GHz
Small Signal Gain		36		dB
Input Return Loss		13.5		dB
Output Return Loss		10		dB
Output Power (at $P_{IN} = 15$ dBm)		42.5		dBm
Power Added Efficiency (at $P_{IN} = 15$ dBm)		40		%
Power Gain (at $P_{IN} = 15$ dBm)		28		dB
Output Power Temperature Coefficient (25 °C to 85 °C only)		Pulsed CW		dBm/°C
		-0.003 -0.01		
Recommended Operating Voltage	25	28	32	V

Test conditions unless otherwise noted: 25 °C, $V_D = 28$ V (PW = 100 μ s, DC = 10 %), $I_{DQ} = 365$ mA, $V_G = -2.6$ V typical.

Thermal and Reliability Information

Parameter	Test Conditions	Value	Units
Thermal Resistance (θ_{JC}) ⁽¹⁾	CW, $V_D = 28$ V, $I_{DQ} = 365$ mA,	2.25	$^{\circ}\text{C}/\text{W}$
Channel Temperature (T_{CH}) (under RF drive)	$T_{BASE} = 85^{\circ}\text{C}$, Freq = 10.5 GHz, $P_{IN} = 15$ dBm, $P_{OUT} = 42.4$ dBm $P_{DISS} = 24$ W, $I_{D_Drive} = 1.46$ A	139	$^{\circ}\text{C}$
Thermal Resistance (θ_{JC}) ⁽¹⁾	$V_D = 28$ V, $I_{DQ} = 365$ mA,	1.57	$^{\circ}\text{C}/\text{W}$
Channel Temperature (T_{CH}) (under RF drive)	(Pulsed: PW = 100 μs , DC = 10 %), $T_{BASE} = 85^{\circ}\text{C}$, Freq = 10.5 GHz, $P_{IN} = 15$ dBm, $P_{OUT} = 42.8$ dBm, $P_{DISS} = 26$ W, $I_{D_Drive} = 1.61$ A	126	$^{\circ}\text{C}$

Notes:

1. Thermal resistance measured to back of package.
2. Refer to the following document: [GaN Device Channel Temperature, Thermal Resistance, and Reliability Estimates](#)

Power Dissipation

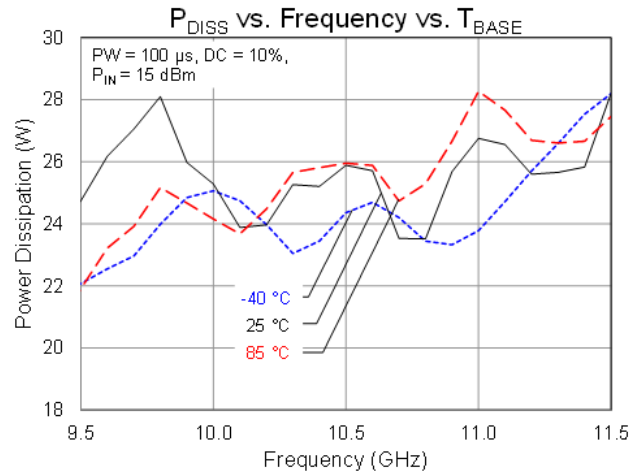
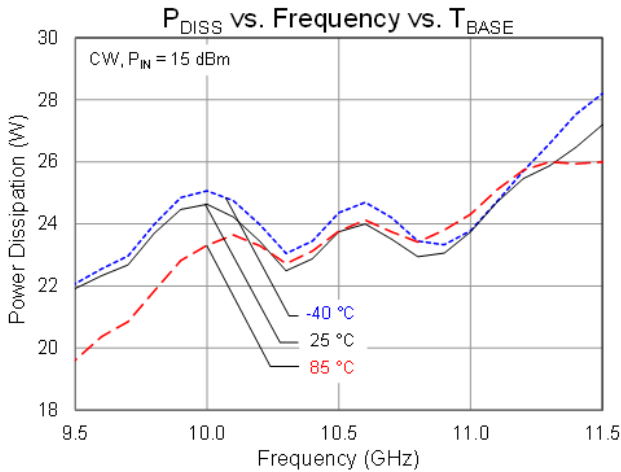

Typical Performance – Large Signal

Conditions unless otherwise specified: $V_D = 28\text{ V}$, $I_{DQ} = 365\text{ mA}$, $V_G = -2.6\text{ V}$ typical.

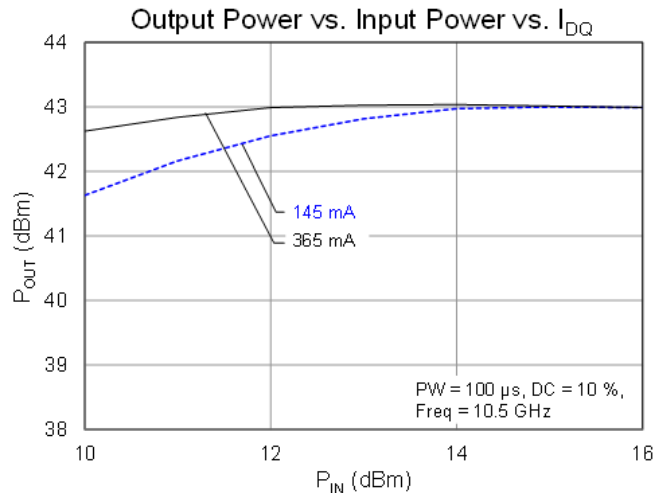
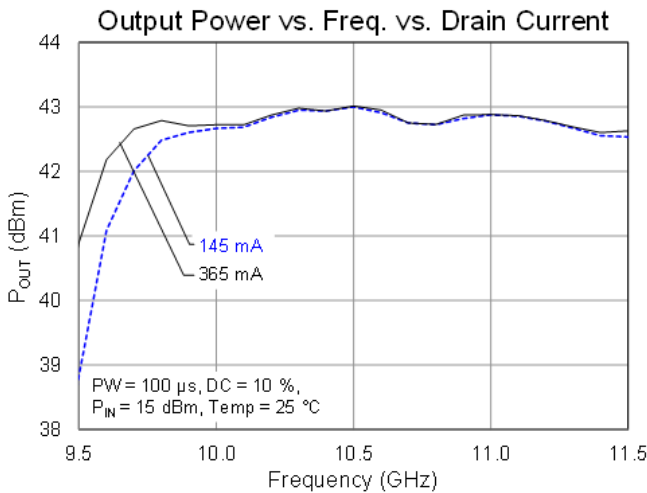
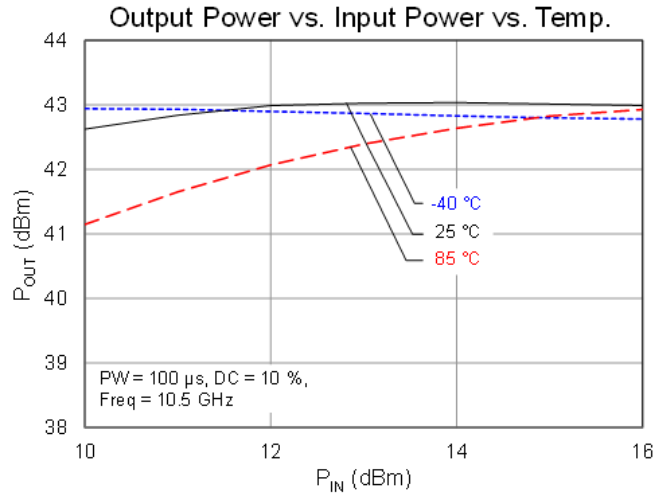
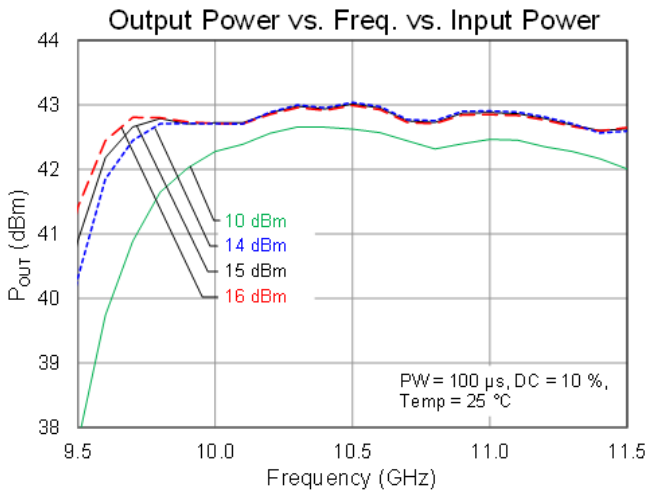
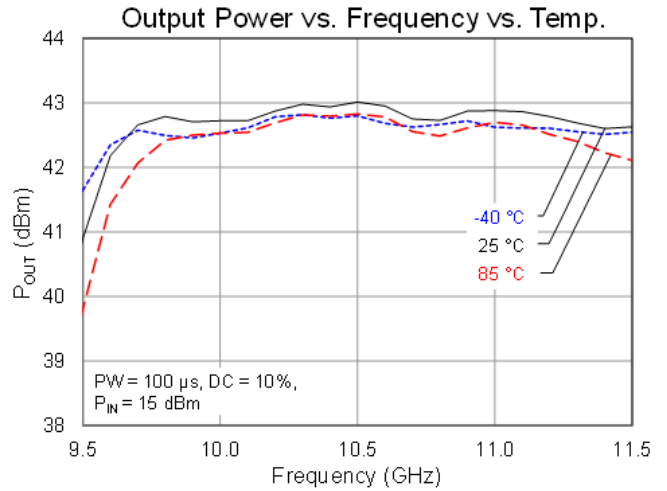
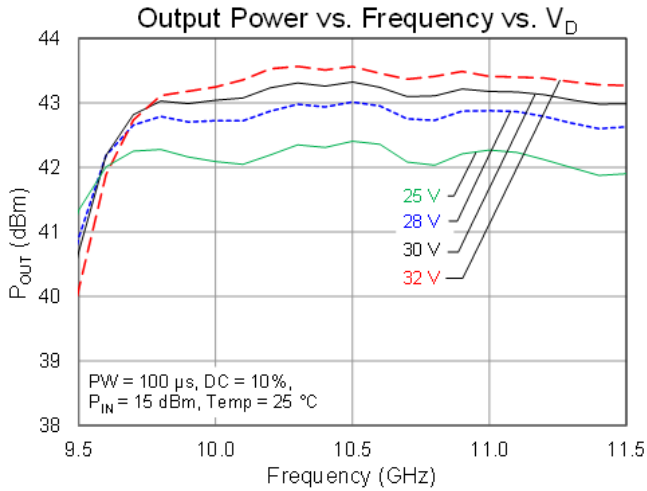

Typical Performance – Large Signal (Pulsed)

Conditions unless otherwise specified: $V_D = 28\text{ V}$, $I_{DQ} = 365\text{ mA}$, $V_G = -2.6\text{ V}$ typical.

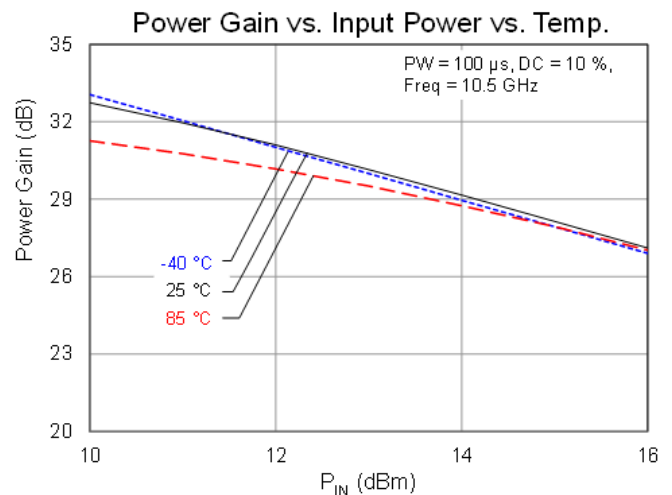
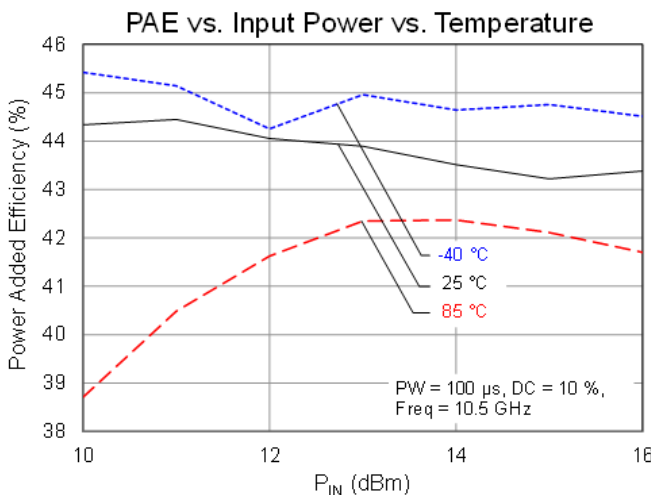
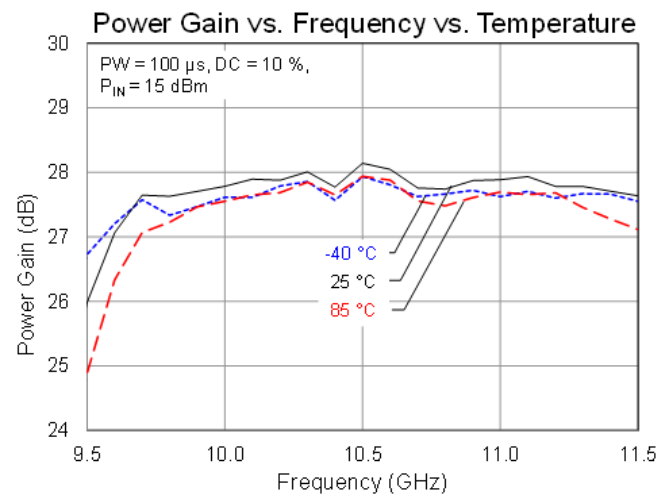
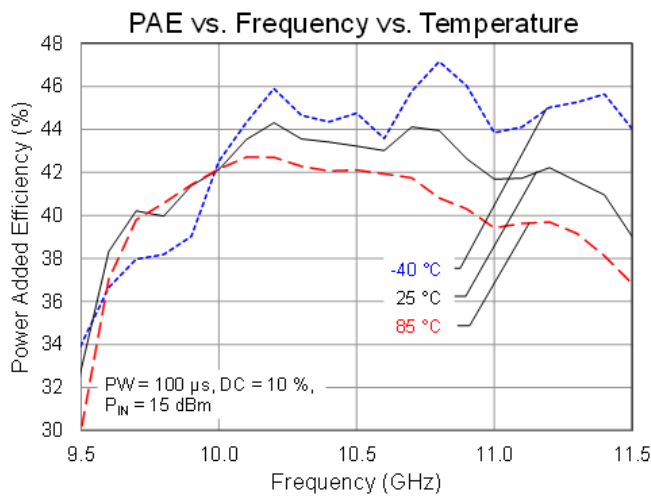
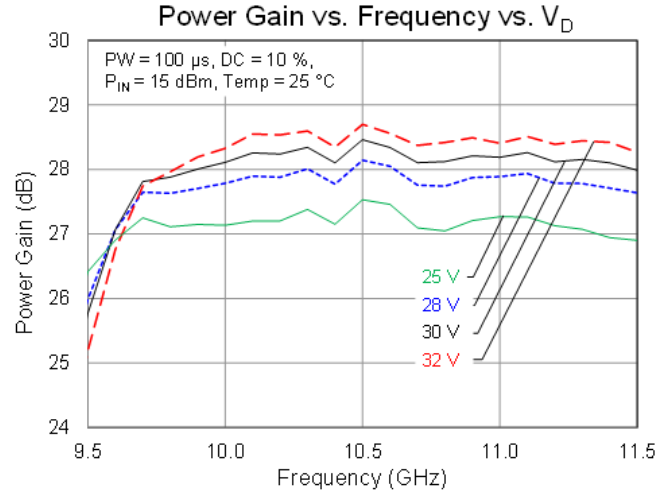
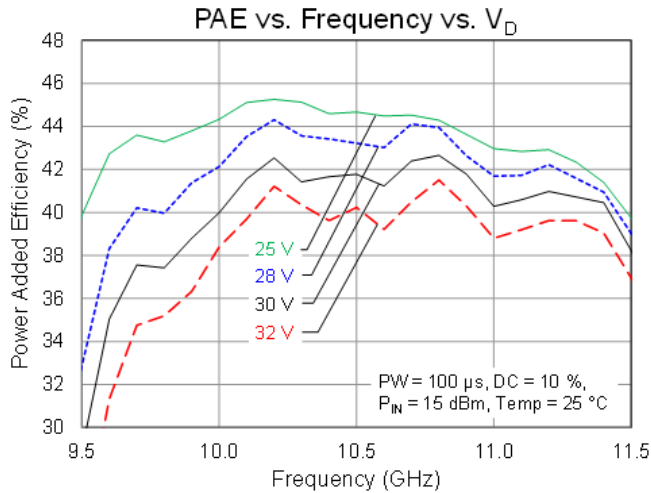

Typical Performance – Large Signal (Pulsed)

Conditions unless otherwise specified: $V_D = 28\text{ V}$, $I_{DQ} = 365\text{ mA}$, $V_G = -2.6\text{ V}$ typical.

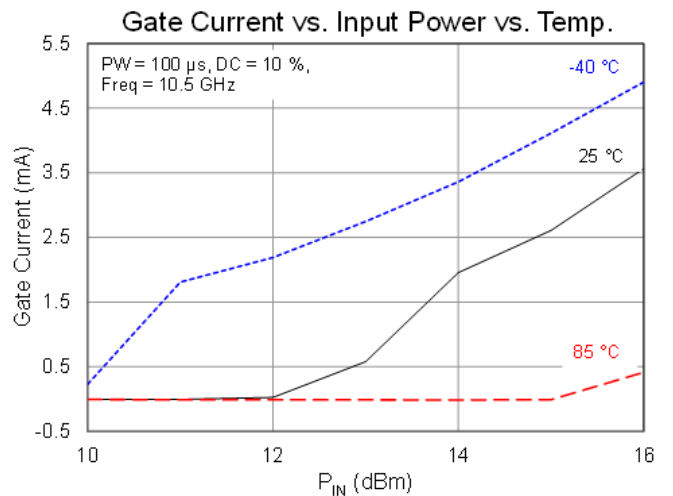
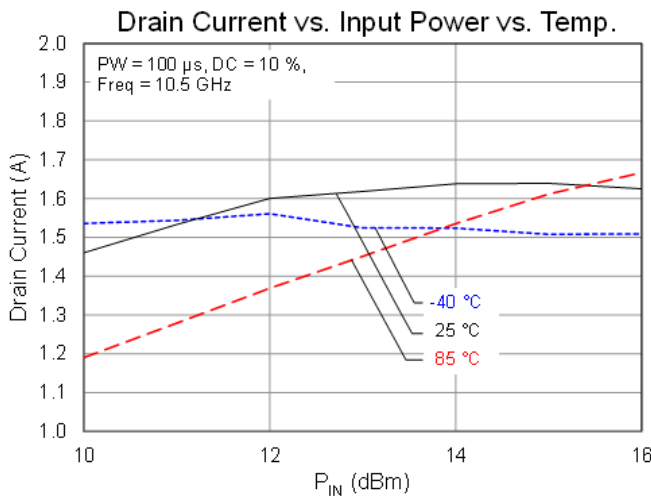
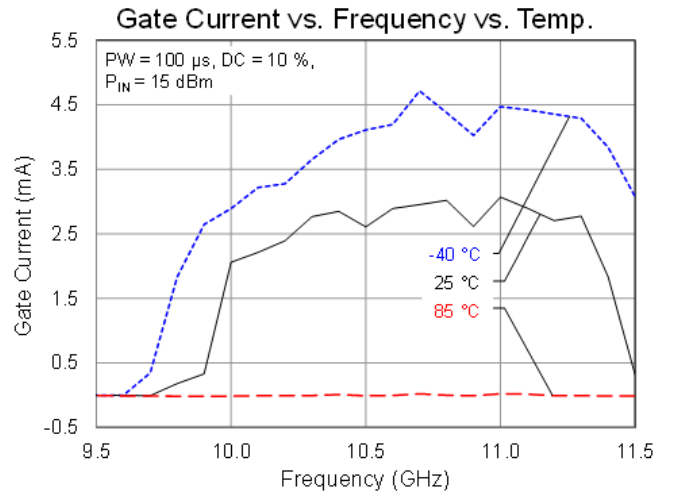
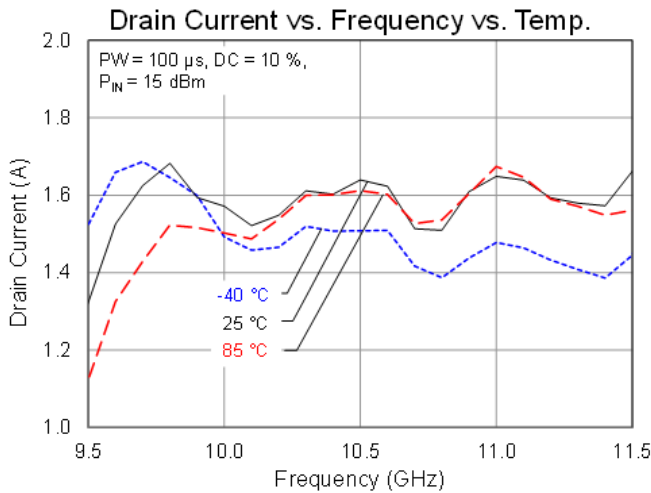
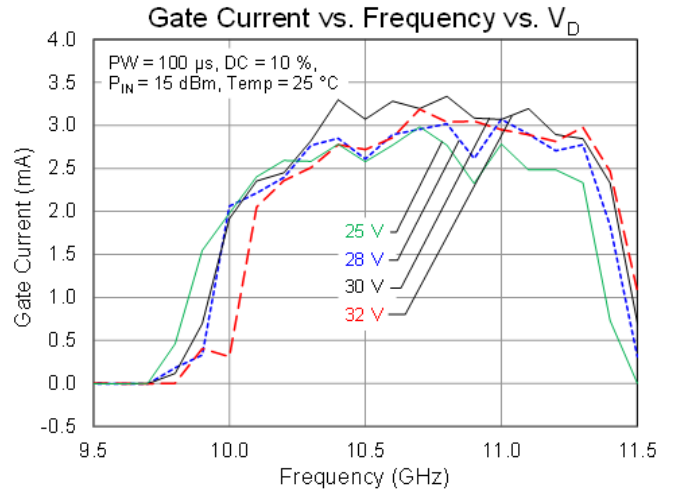
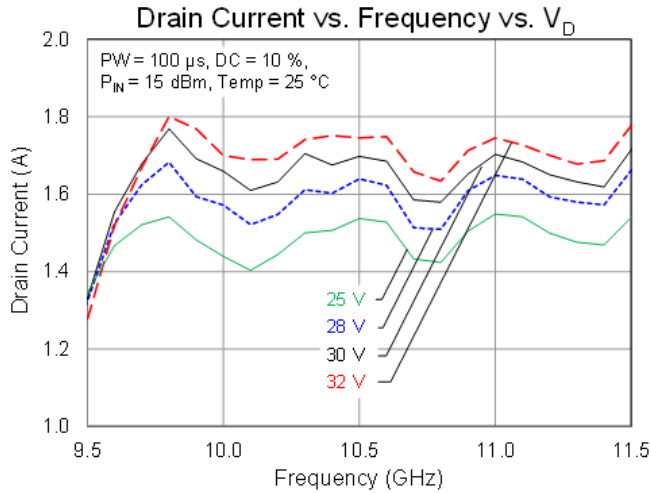

Performance Plots – Large Signal (CW)

Conditions unless otherwise specified: $V_D = 28\text{ V}$, $I_{DQ} = 365\text{ mA}$, $V_G = -2.6\text{ V}$ typical.

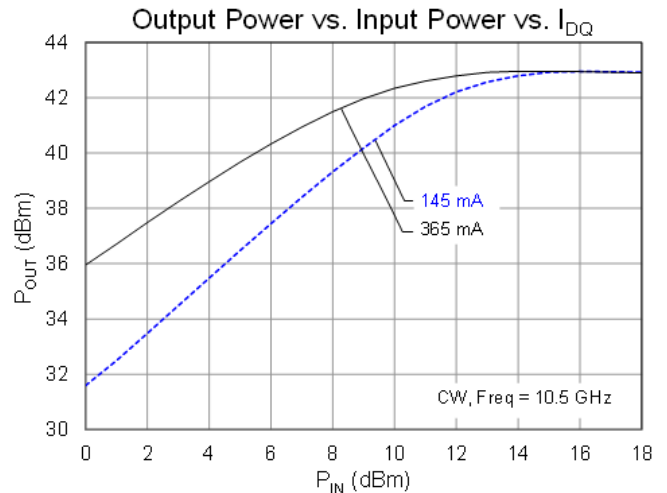
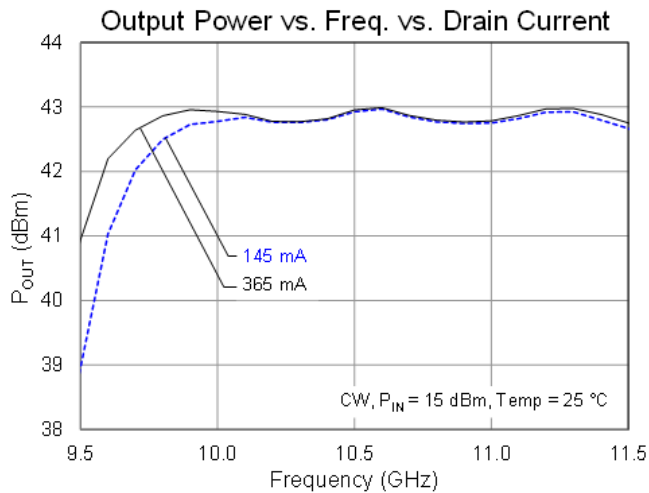
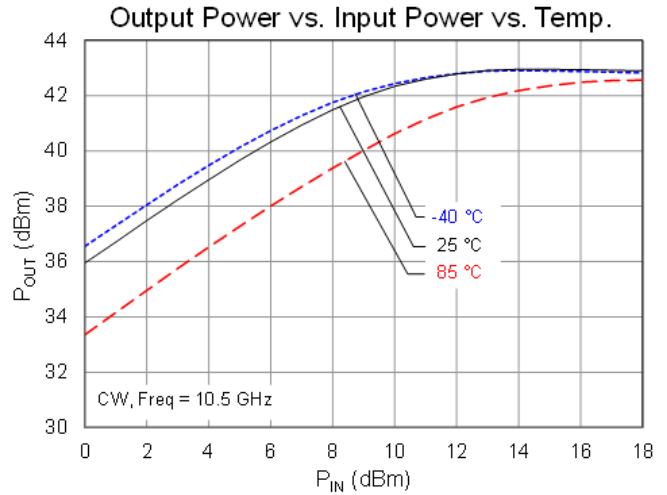
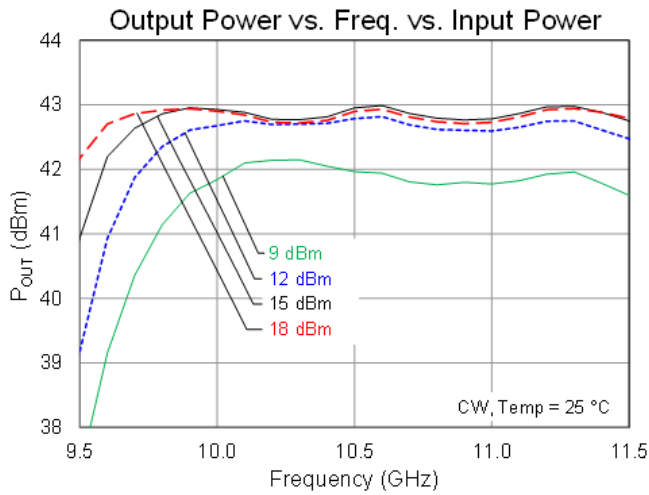
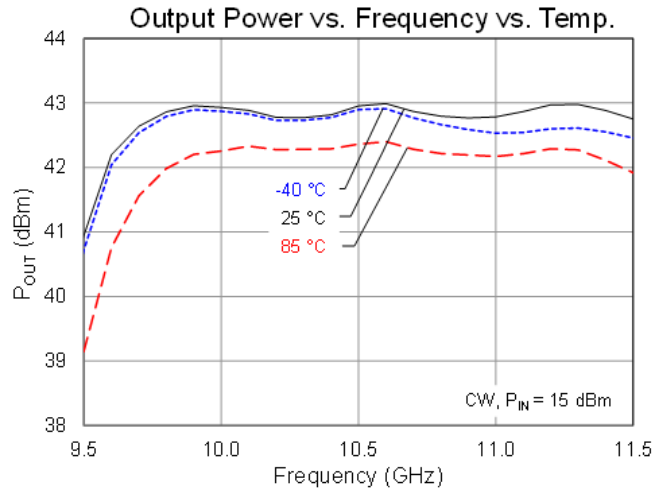
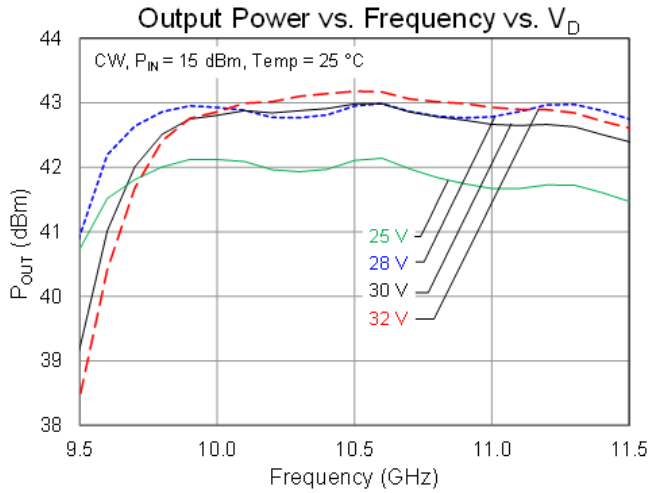

Performance Plots – Large Signal (CW)

Conditions unless otherwise specified: $V_D = 28\text{ V}$, $I_{DQ} = 365\text{ mA}$, $V_G = -2.6\text{ V}$ typical.

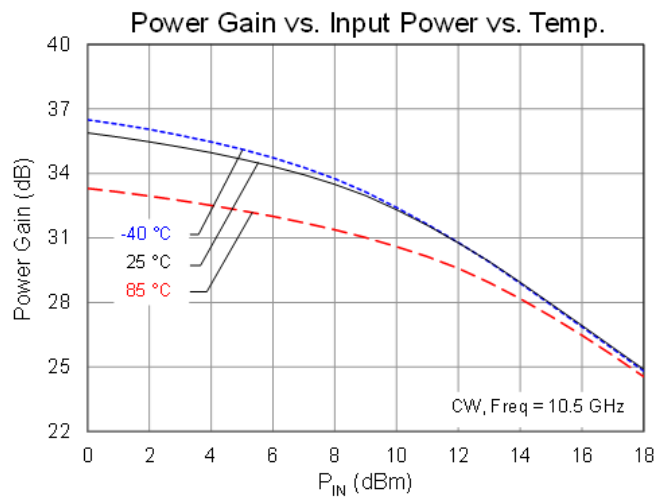
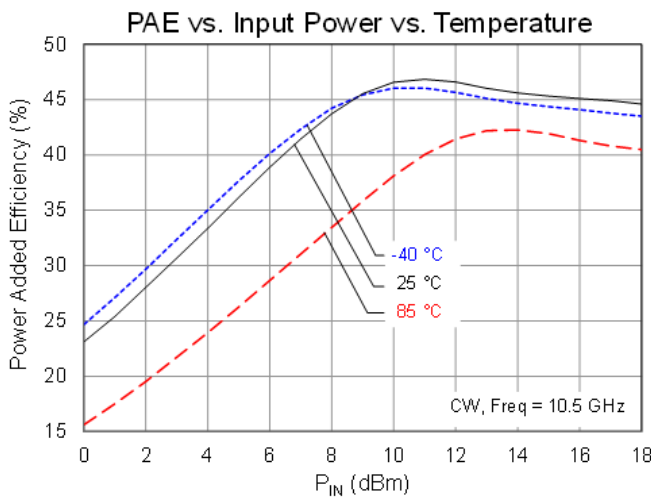
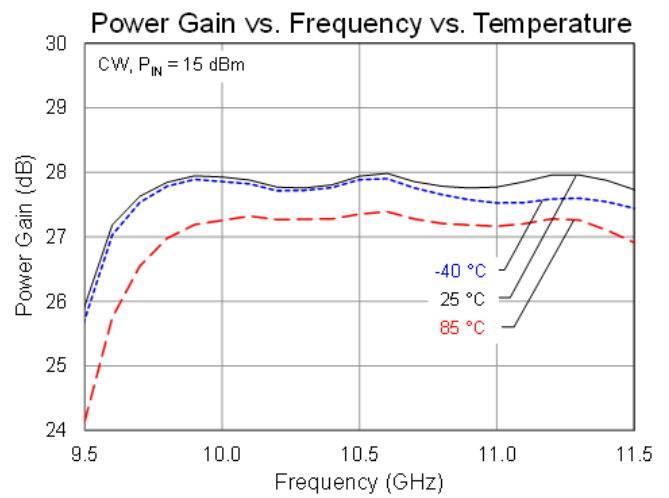
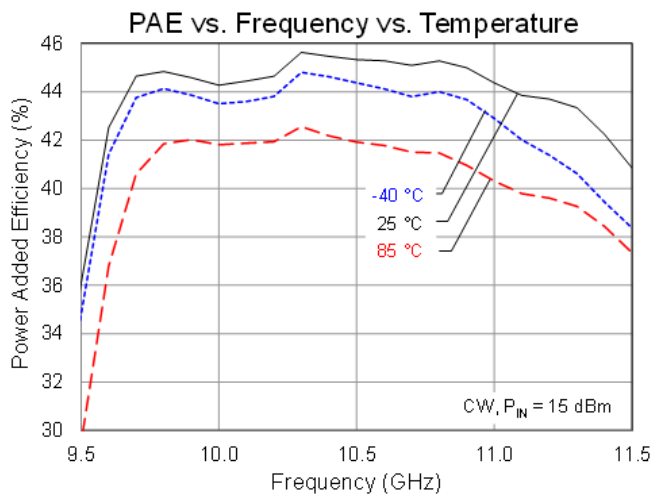
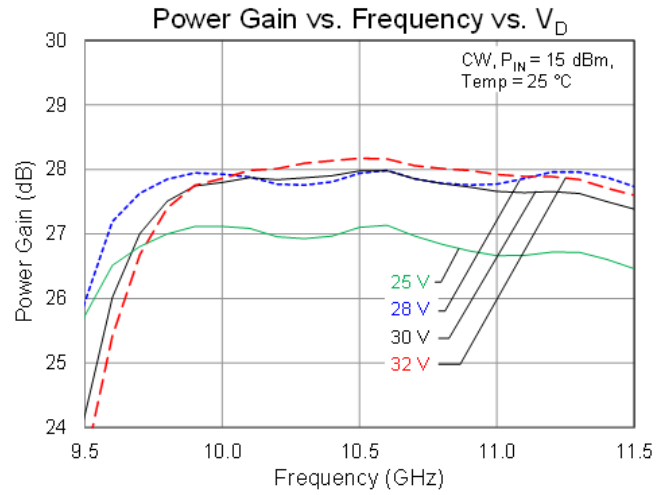
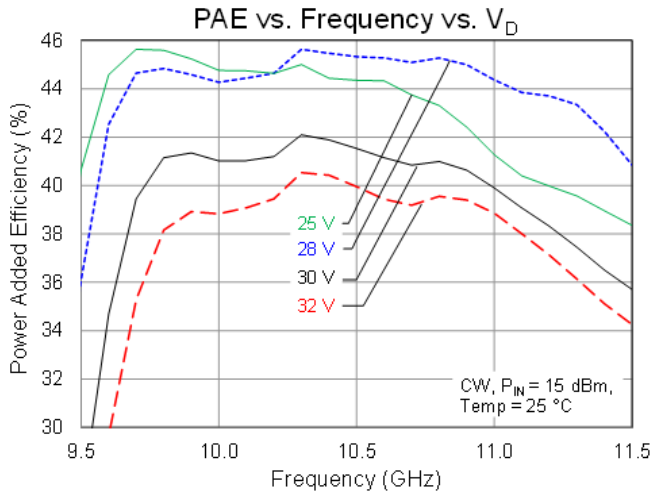

Performance Plots – Large Signal (CW)

Conditions unless otherwise specified: $V_D = 28\text{ V}$, $I_{DQ} = 365\text{ mA}$, $V_G = -2.6\text{ V}$ typical.

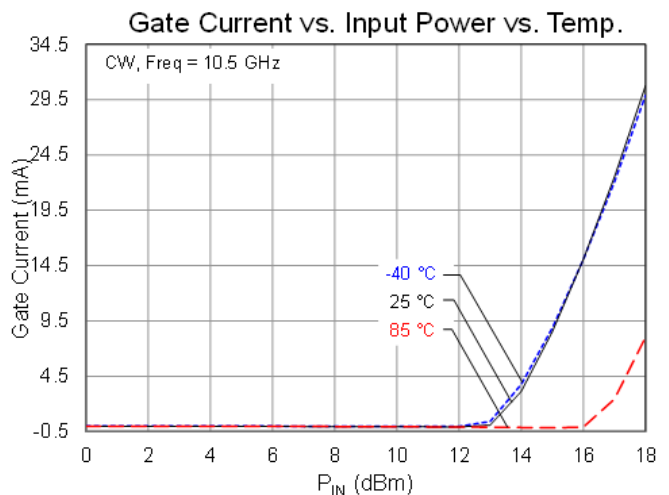
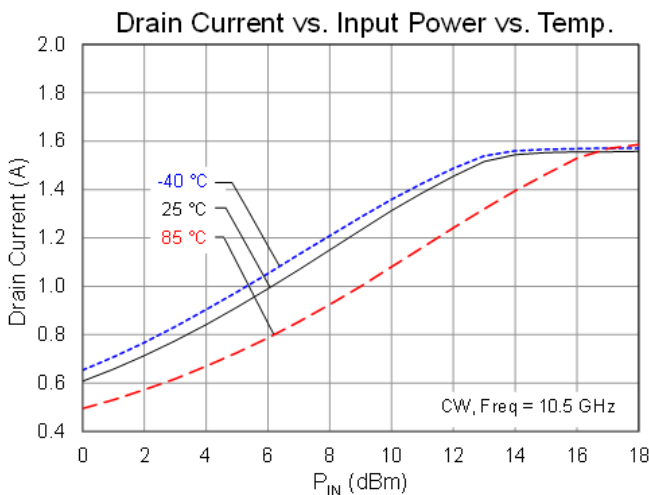
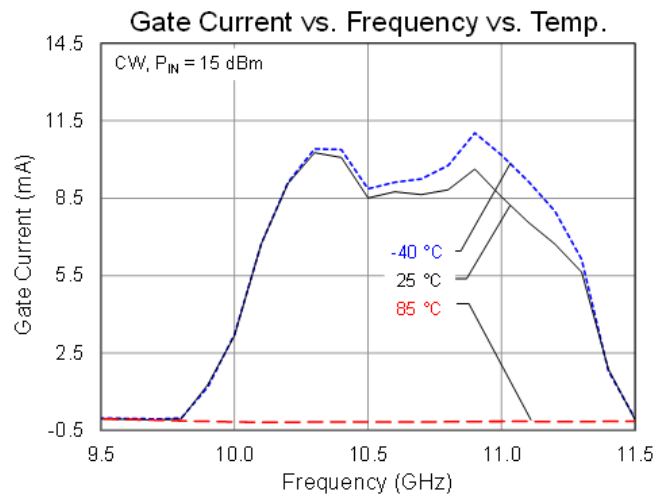
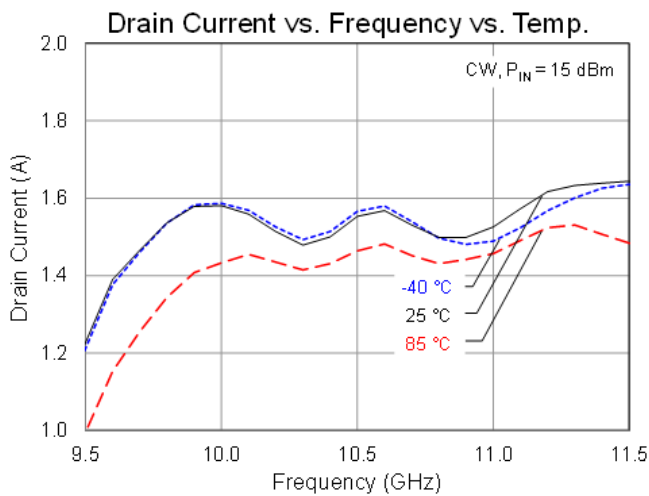
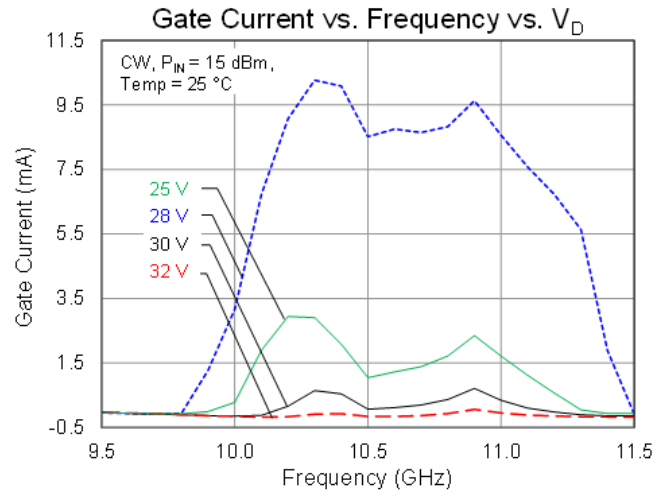
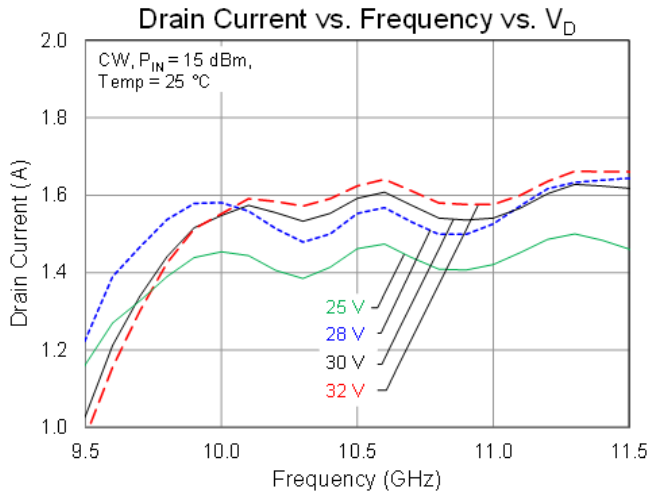

Typical Performance – Linearity

Conditions unless otherwise specified: $V_D = 28\text{ V}$, $I_{DQ} = 365\text{ mA}$, $V_G = -2.6\text{ V}$ typical.

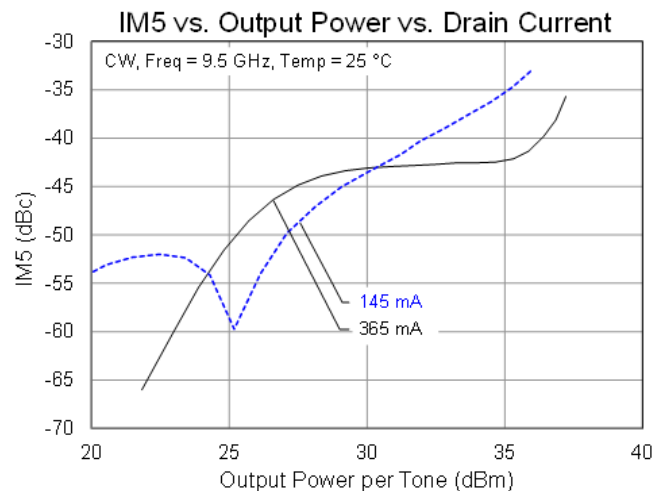
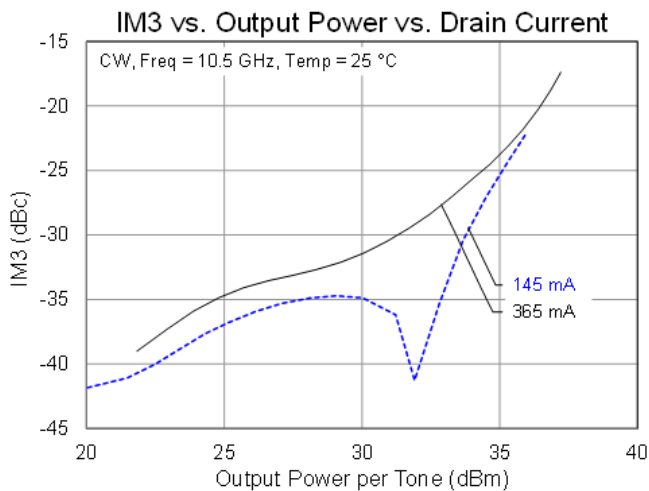
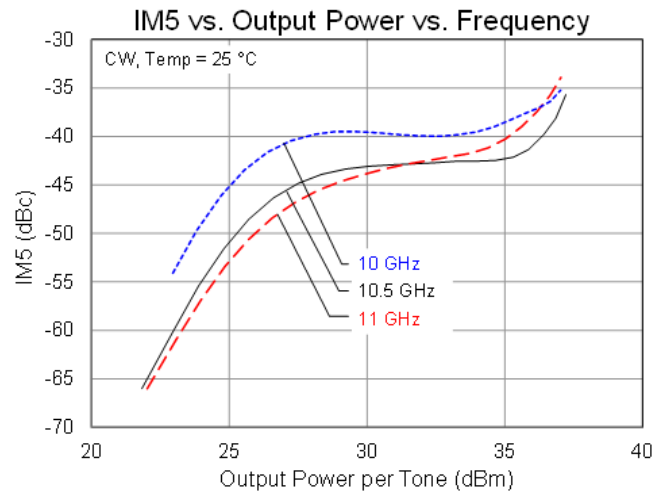
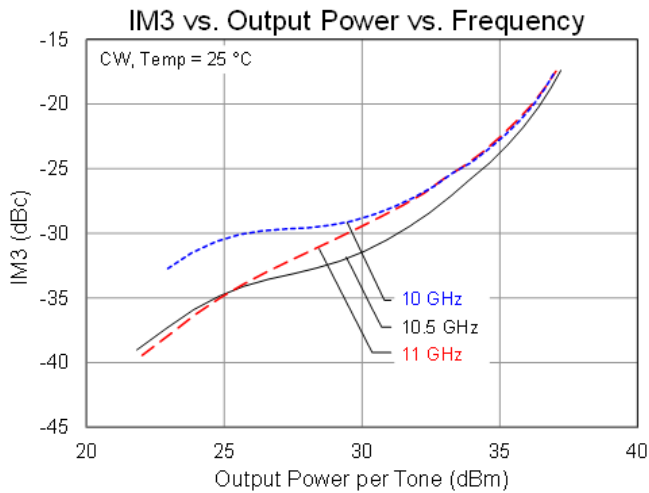
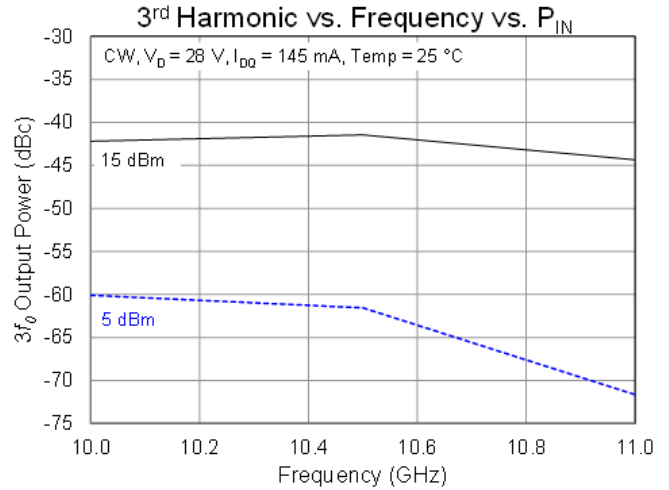
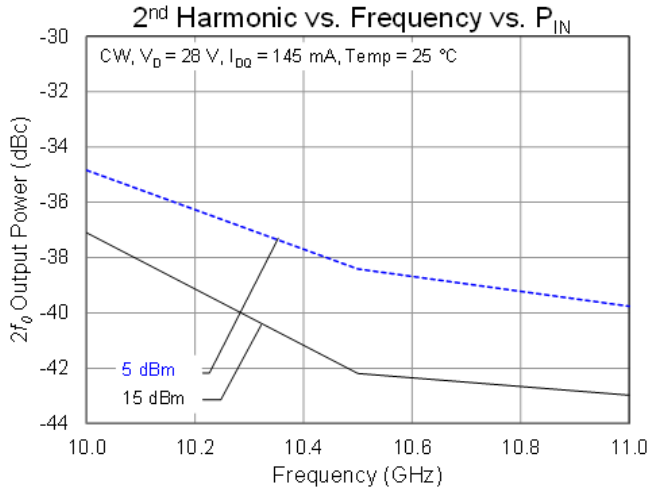

Typical Performance – Small Signal

Conditions unless otherwise specified: $V_D = 28\text{ V}$, $I_{DQ} = 365\text{ mA}$, $V_G = -2.6\text{ V}$ typical.

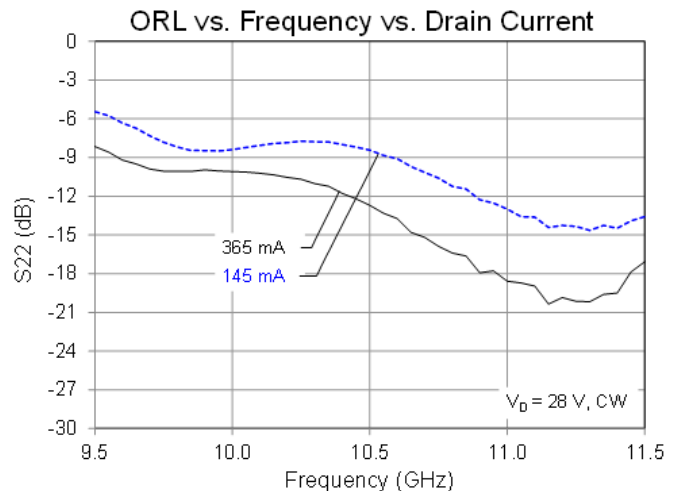
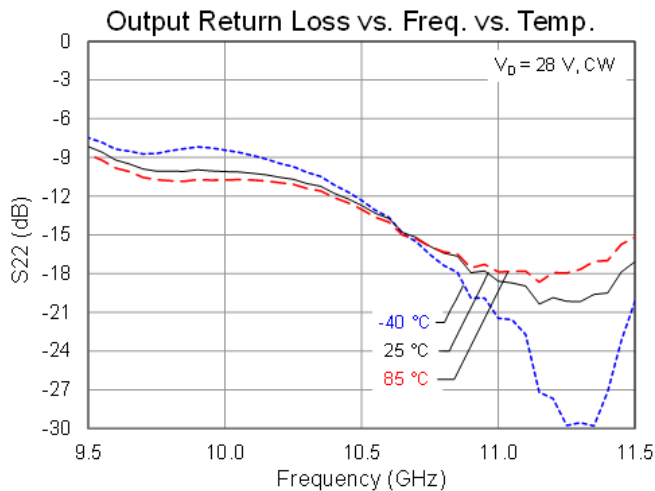
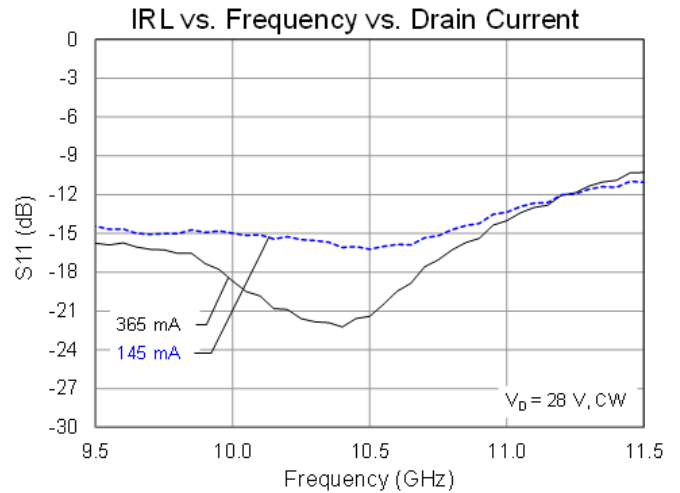
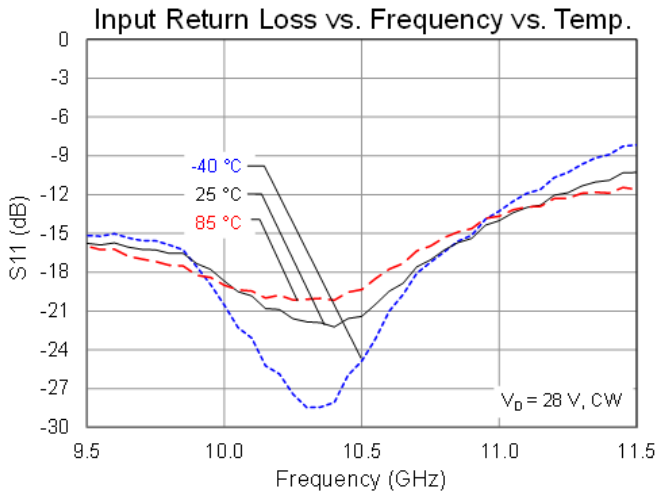
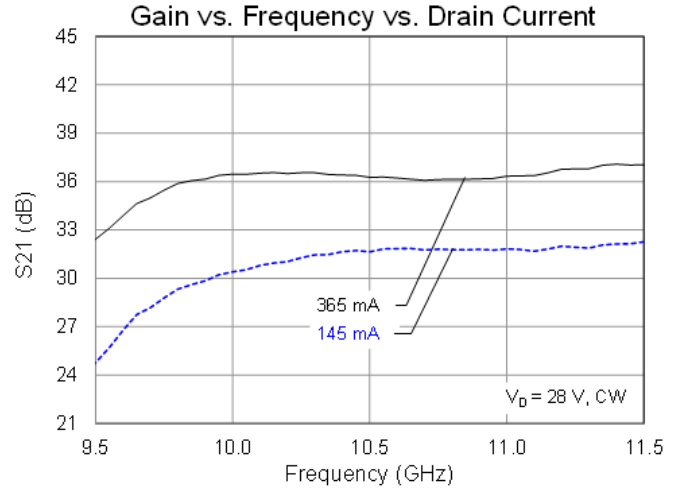
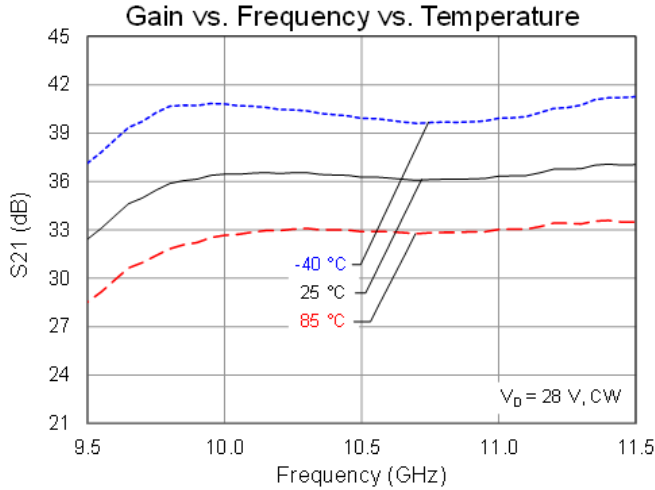

Applications Information and Pin Layout

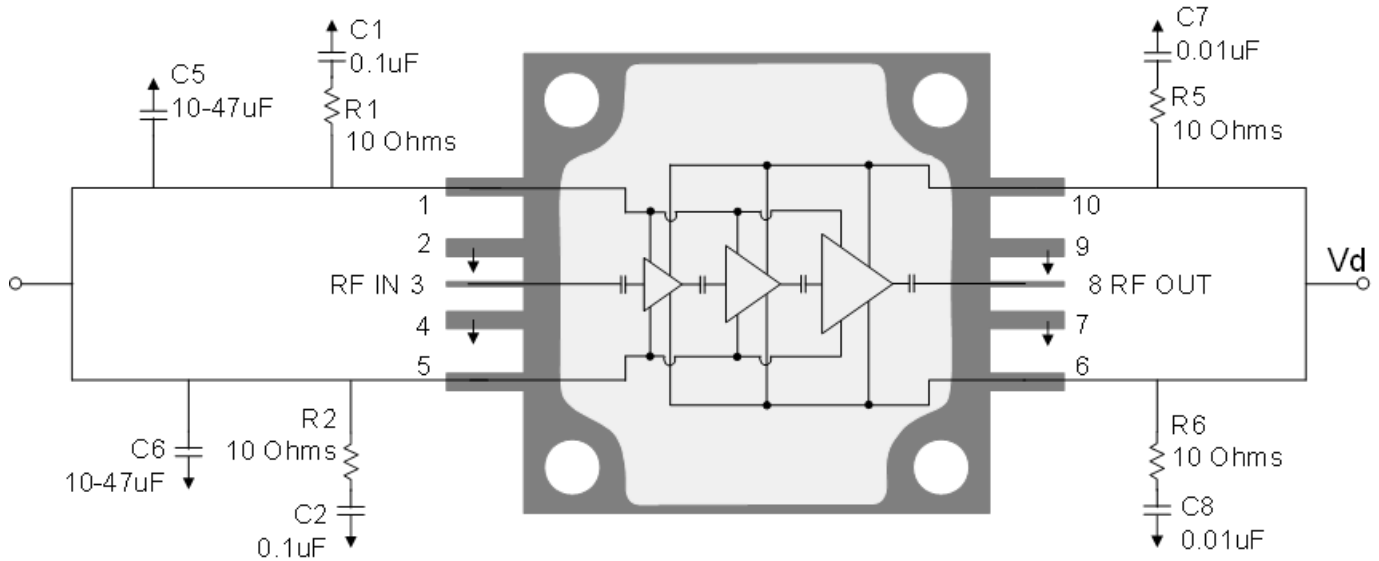

Bias Up Procedure

1. Set I_D limit to 3 A, I_G limit to 14 mA
2. Apply -5 V to V_G
3. Apply $+28$ V to V_D ; ensure I_{DQ} is approx. 0 mA
4. Adjust V_G until $I_{DQ} = 365$ mA ($V_G \sim -2.6$ V Typ.).
5. Turn on RF supply

Bias Down Procedure

1. Turn off RF supply
2. Reduce V_G to -5 V; ensure I_{DQ} is approx. 0 mA
3. Set V_D to 0 V
4. Turn off V_D supply
5. Turn off V_G supply

Pin Description

Pad No.	Symbol	Description
1, 5	V_G	Gate Voltage; Bias network is required; must be biased from both sides; see recommended Application Information above.
3	RF_{IN}	Output; matched to 50Ω ; DC blocked
2, 4, 7, 9	GND	Must be grounded on the PCB.
6, 10	V_D	Drain voltage; Bias network is required; must be biased from both sides; see recommended Application Information above.
8	RF_{OUT}	Input; matched to 50Ω ; DC blocked

Evaluation Board (EVB)

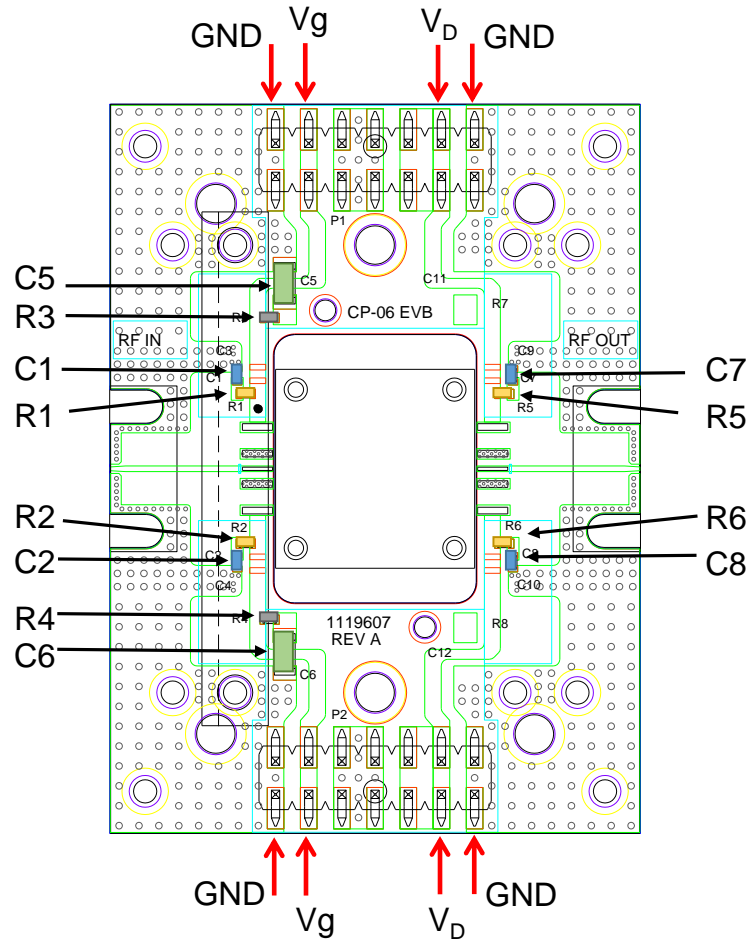

NOTES:

- (1) Both Top and Bottom Vd and Vg must be biased.

Bill of Materials

Reference Des.	Value	Description	Manuf.	Part Number
C1, C2	0.1 uF	Cap, 0402, 50 V, 10%, X7R	Various	
C5, C6	10-47 uF	Cap, 1206, 50 V, 20%, X5R (10v is OK)	Various	
C7, C8	0.01 uF	Cap, 0402, 50V, 10%, X7R	Various	
R1, R2, R5, R6	10 Ohms	Res, 0402, 50V, 5%	Various	
R3, R4	0 Ohms	Res, 0402, jumper required for the above EVB design	Various	

Assembly Notes

1. Carefully clean the PC board and package leads with alcohol. Allow it to dry fully.
2. To improve the thermal and RF performance, Qorvo recommends attaching a heat sink to the bottom of the PCB and apply thermal compound (Arctic Silver 5 recommended) or 4 mil indium shim between the heat sink and the package.
3. (The following is for *information only*. There are many variables in a second level assembly that Qorvo does not control, so Qorvo does not recommend an absolute torque value.) Use screws to attach the component to the heat sink. A suggested torque value is 16 in-oz. for a 0-80 screw. Start with screws finger tight, then torque to 8 in-oz., then torque to final value. Use the following tightening pattern:

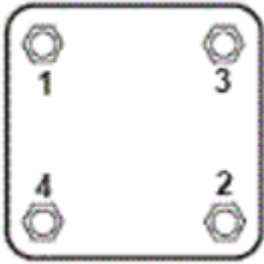

4. Apply no-flux solder to each pin of the TGA2625-CP. The component leads should be manually soldered, and the package cannot be subjected to conventional reflow processes. The use of no-clean solder to avoid washing after soldering is recommended.

Mechanical Information

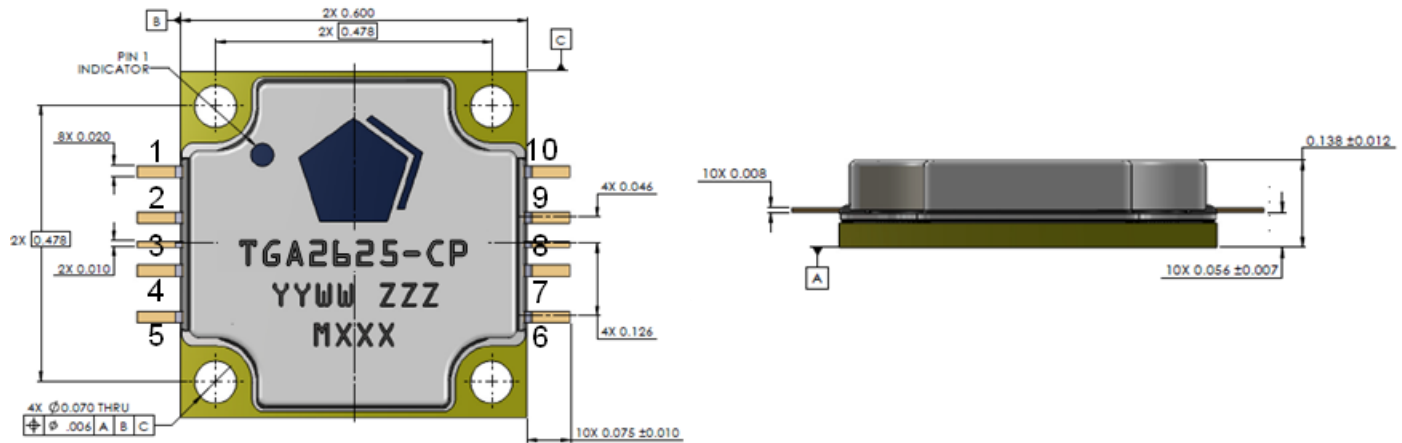

Units: inches

Tolerances: unless specified

x.xx = ± 0.01

x.xxx = ± 0.005

Materials:

Base: Copper

Lid: Plastic

All metalized features are gold plated

Part is epoxy sealed

Marking:

2625: Part number

YY: Part Assembly year

WW: Part Assembly week

ZZZ: Serial Number

MXXX: Batch ID

Handling Precautions

Parameter	Rating	Standard
ESD – Human Body Model (HBM)	1B	ESDA / JEDEC JS-001-2014
ESD – Charged Device Model (CDM)	C0B	ESDA / JEDEC JS-002-2014
MSL – Moisture Sensitivity Level	N/A	



Caution!
ESD-Sensitive Device

Solderability

The component leads should be manually soldered, and the package cannot be subjected to conventional reflow processes. Soldering of the component leads is compatible with the latest version of J-STD-020, lead-free solder, 260 °C. The use of no-clean solder to avoid washing after soldering is recommended.

RoHS Compliance

This product is compliant with the 2011/65/EU RoHS directive (Restrictions on the Use of Certain Hazardous Substances in Electrical and Electronic Equipment), as amended by Directive 2015/863/EU. This product also has the following attributes:

- Lead Free
- Halogen Free (Chlorine, Bromine)
- Antimony Free
- TBBP-A (C₁₅H₁₂Br₄O₂) Free
- PFOS Free
- SVHC Free

Contact Information

For the latest specifications, additional product information, worldwide sales and distribution locations:

Web: www.qorvo.com
Tel: 1-844-890-8163
Email: customer.support@qorvo.com

Important Notice

The information contained herein is believed to be reliable; however, Qorvo makes no warranties regarding the information contained herein and assumes no responsibility or liability whatsoever for the use of the information contained herein. All information contained herein is subject to change without notice. Customers should obtain and verify the latest relevant information before placing orders for Qorvo products. The information contained herein or any use of such information does not grant, explicitly or implicitly, to any party any patent rights, licenses, or any other intellectual property rights, whether with regard to such information itself or anything described by such information. **THIS INFORMATION DOES NOT CONSTITUTE A WARRANTY WITH RESPECT TO THE PRODUCTS DESCRIBED HEREIN, AND QORVO HEREBY DISCLAIMS ANY AND ALL WARRANTIES WITH RESPECT TO SUCH PRODUCTS WHETHER EXPRESS OR IMPLIED BY LAW, COURSE OF DEALING, COURSE OF PERFORMANCE, USAGE OF TRADE OR OTHERWISE, INCLUDING THE IMPLIED WARRANTIES OF MERCHANTABILITY AND FITNESS FOR A PARTICULAR PURPOSE.**

Without limiting the generality of the foregoing, Qorvo products are not warranted or authorized for use as critical components in medical, life-saving, or life-sustaining applications, or other applications where a failure would reasonably be expected to cause severe personal injury or death.

Copyright 2018 © Qorvo, Inc. | Qorvo is a registered trademark of Qorvo, Inc.

Mouser Electronics

Authorized Distributor

Click to View Pricing, Inventory, Delivery & Lifecycle Information:

[Qorvo:](#)

[TGA2625-CP](#)