

HLMP-D150, HLMP-D155, HLMP-K150, and HLMP-K155

T-1^{3/4} (5 mm), T-1 (3 mm), Low Current, AllnGaP Deep Red LED Lamps

Description

The Broadcom[®] HLMP-D150, HLMP-D155, HLMP-K150, and HLMP-K155 solid-state LED lamps use AllnGaP material technology. This LED material has outstanding light output efficiency at very low drive currents. The color is deep red at the dominant wavelength of 640 nm. These lamps are ideally suited for use in applications where high light output is required with minimum power output.

Features

- Minimum luminous intensity specified at 1 mA
- High light output at low currents
- Wide viewing angle
- Outstanding material efficiency
- Low power/low forward voltage
- CMOS/MOS compatible
- TTL compatible
- Deep red color

Applications

- Low power circuits
- Battery powered equipment
- Telecommunication indicators

Package Dimensions

Package Outline A

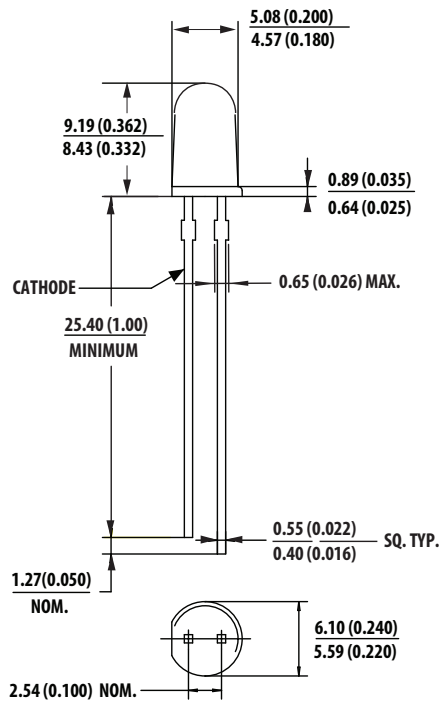

A.

Package Outline B

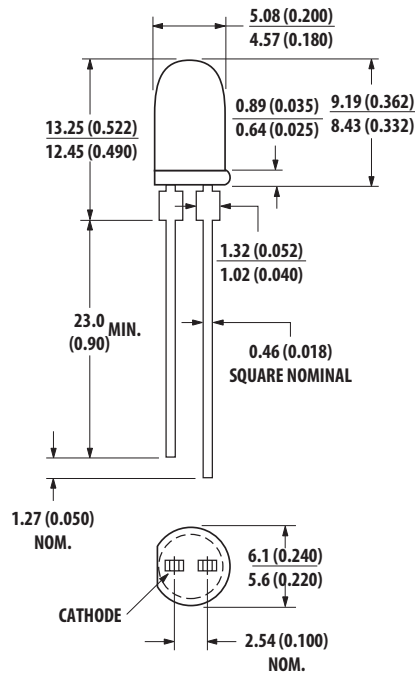

B.

Package Outline C

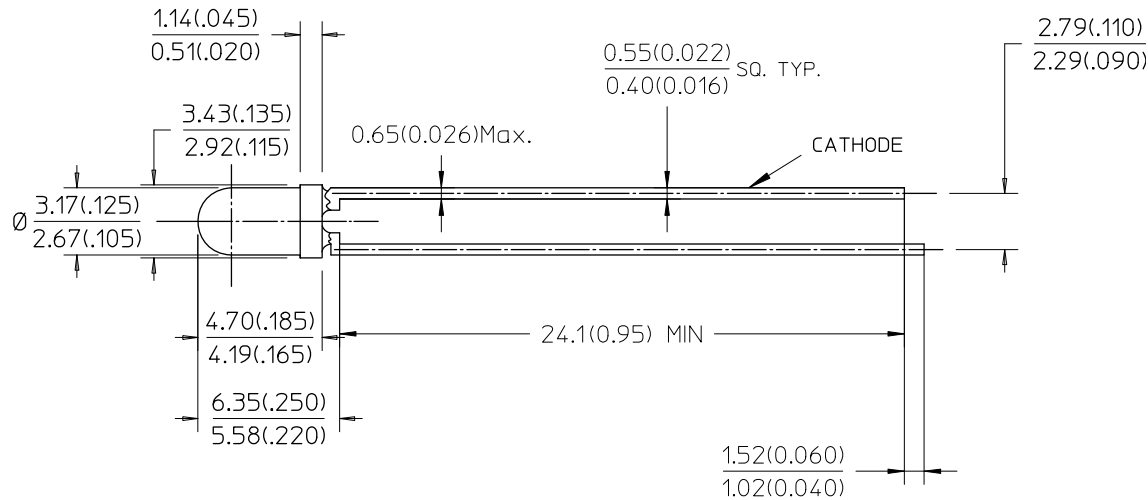

NOTE:

1. All dimensions are in mm (in.).
2. An epoxy meniscus may extend about 1 mm (0.040 in.) down the leads.
3. For PCB hole recommendations, see the Precautions section.

Device Selection Guide

| Package Description | Device HLMP- | Luminous Intensity I _v (mcd) at 1 mA | | | 2θ _{1/2} ^a Degree | Package Outline |
|--------------------------------|--------------|---|------|------|--|--------------------|
| | | Min. | Typ. | Max. | | |
| T-1¼ Red Tinted Diffused | D150 | 1.3 | 3.0 | — | 65 | A |
| | D150-C00xx | 1.3 | 3.0 | — | 65 | A |
| T-1¼ Red Untinted Non-diffused | D155 | 5.4 | 10.0 | — | 24 | B |
| | D155-F00xx | 5.4 | 10.0 | — | 24 | B |
| T-1 Red Tinted Diffused | K150 | 1.3 | 2.0 | — | 60 | C |
| | K150-C00xx | 1.3 | 2.0 | — | 60 | C |
| T-1 Red Untinted Non-diffused | K155 | 2.1 | 3.0 | — | 45 | C |
| | K155-D00xx | 2.1 | 3.0 | — | 45 | C |

a. θ_{1/2} is the off axis angle from lamp centerline where the luminous intensity is ½ the on-axis value.

Absolute Maximum Ratings at T_A = 25°C

| Parameter | Value |
|---|-----------------|
| Peak Forward Current ^a | 300 mA |
| Average Forward Current ^b | 20 mA |
| DC Current ^b | 30 mA |
| Power Dissipation | 87 mW |
| Reverse Voltage (I _R = 100 µA) | 5V |
| LED Junction Temperature | 110°C |
| Operating Temperature Range | -20°C to +100°C |
| Storage Temperature Range | -40°C to +100°C |

a. Maximum I_{PEAK} at f = 1 kHz, DF = 6.7%.

b. Derate linearly as shown in [Figure 4](#).

Electrical/Optical Characteristics at $T_A = 25^\circ\text{C}$

| Parameter | Symbol | Min. | Typ. | Max. | Unit | Test Condition |
|---------------------------|-----------------------|------|--|------|------|--|
| Forward Voltage | V_F | — | 1.7 | 2.2 | V | $I_F = 1 \text{ mA}$ |
| Reverse Breakdown Voltage | V_R | 5.0 | — | — | V | $I_R = 100 \mu\text{A}$ |
| Peak Wavelength | λ_p | — | 660 | — | nm | Measurement at Peak |
| Dominant Wavelength | λ_d | — | 640 | — | nm | Note ^a |
| Spectral Line Halfwidth | $\Delta\lambda_{1/2}$ | — | 20 | — | nm | Wavelength width at spectral distribution ½ power point. |
| Speed of Response | τ_S | — | 30 | — | ns | Exponential Time Constant, e^{-t}/T_S |
| Capacitance | C | — | 30 | — | pF | $V_F = 0$, $f = 1 \text{ MHz}$ |
| Thermal Resistance | $R\theta_{J-PIN}$ | — | 260 ^b 210 ^c 290 ^d | — | °C/W | Junction to Cathode Lead |
| Luminous Efficacy | η_V | — | 65 | — | lm/W | Note ^e |

a. The dominant wavelength, λ_d , is derived from the CIE chromaticity diagram and represents the color of the device.

b. HLMP-D150.

c. HLMP-D155.

d. HLMP-K150/-K155.

e. The radiant intensity, I_e , in watts per steradian, may be found from the equation $I_e = I_V/\eta_V$, where I_V is the luminous intensity in candelas and η_V is luminous efficacy in lumens/watt.

Part Numbering System

H L M P -

| | | | |
|----------------|----------------|----------------|----------------|
| X ₁ | X ₂ | X ₃ | X ₄ |
|----------------|----------------|----------------|----------------|

 -

| | | | | |
|----------------|----------------|----------------|----------------|----------------|
| X ₅ | X ₆ | X ₇ | X ₈ | X ₉ |
|----------------|----------------|----------------|----------------|----------------|

| Code | Description | Option | |
|-------------------------------|-----------------------|--|-----------------------------------|
| X ₁ | Package type | D | T-1¼ (5 mm) |
| | | K | T-1 (3 mm) |
| X ₂ | Color options | 1 | Deep Red |
| X ₃ X ₄ | Lens type | 50 | Tinted, diffused |
| | | 55 | Untinted, non-diffused |
| X ₅ | Minimum intensity bin | See Intensity Bin Limits | |
| X ₆ | Maximum intensity bin | 0 | Open binning (no maximum limit) |
| X ₇ | Color bin selection | 0 | Full range |
| X ₈ X ₉ | Packaging option | 00 | Bulk packaging |
| | | 02 | Tape and reel |
| | | A1 | Right angle housing, uneven leads |
| | | B2 | Right angle housing, even leads |

Intensity Bin Limits

| Color | Bin | Intensity Range (mcd) | |
|-------|---------|-----------------------|--------|
| | | Min. | Max. |
| Red | C | 1.5 | 2.4 |
| | D | 2.4 | 3.8 |
| | E | 3.8 | 6.1 |
| | F | 6.1 | 9.7 |
| | G | 9.7 | 15.5 |
| | H | 15.5 | 24.8 |
| | I | 24.8 | 39.6 |
| | J | 39.6 | 63.4 |
| | K | 63.4 | 101.5 |
| | L | 101.5 | 162.4 |
| | M | 162.4 | 234.6 |
| | N | 234.6 | 340.0 |
| | O | 340.0 | 540.0 |
| | P | 540.0 | 850.0 |
| | Q | 850.0 | 1200.0 |
| | R | 1200.0 | 1700.0 |
| | S | 1700.0 | 2400.0 |
| | T | 2400.0 | 3400.0 |
| | U | 3400.0 | 4900.0 |
| | V | 4900.0 | 7100.0 |
| W | 7100.0 | 10200.0 | |
| X | 10200.0 | 14800.0 | |
| Y | 14800.0 | 21400.0 | |
| Z | 21400.0 | 30900.0 | |

Maximum tolerance for each bin limit is $\pm 18\%$.

Packaging Option Matrix

| Packaging Option Code | Definition |
|-----------------------|---|
| 00 | Bulk Packaging, minimum increment 500 pieces/bag |
| 02 | Tape and Reel, straight leads, minimum increment 1300 pieces (T-1¼), 1800 pieces (T-1)/reel |
| A1 | T-1 Right Angle Housing, uneven leads, minimum increment 500 pieces/bag |
| B2 | T-1¼ Right Angle Housing, even leads, minimum increment 500 pieces/bag |

NOTE: All categories are established for classification of products. Products may not be available in all categories. Please contact your local Broadcom representative for further clarification/information.

Figure 1: Relative Intensity vs. Wavelength

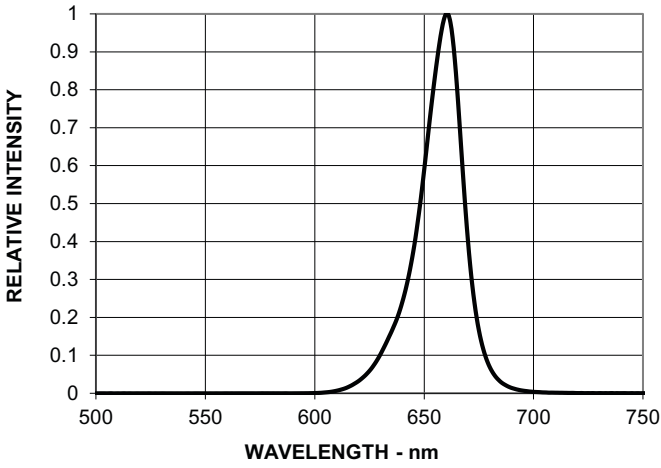

Figure 2: Forward Current vs. Forward Voltage

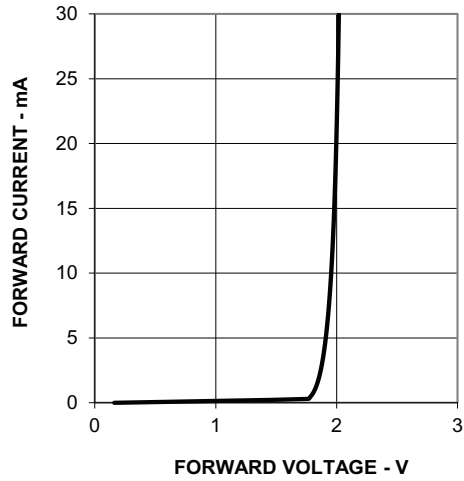

Figure 3: Relative Luminous Intensity vs. DC Forward Current

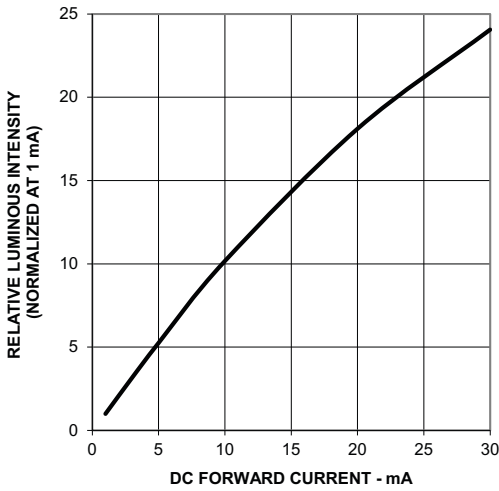

Figure 4: Maximum Forward DC Current vs. Ambient Temperature. Derating based on T_J MAX. = 110°C.

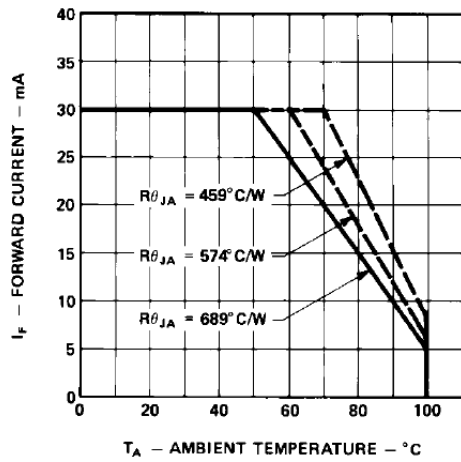

Figure 5: Relative Luminous Intensity vs. Angular Displacement, HLMP-D150

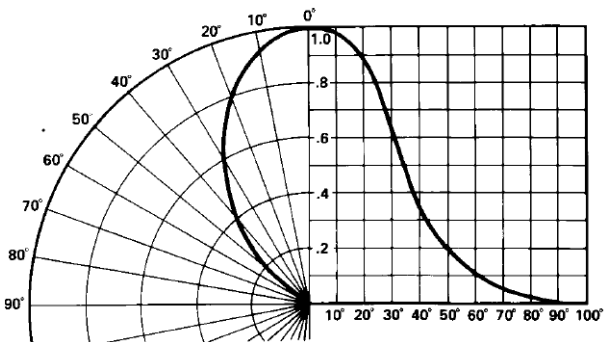

Figure 6: Relative Luminous Intensity vs. Angular Displacement, HLMP-K150

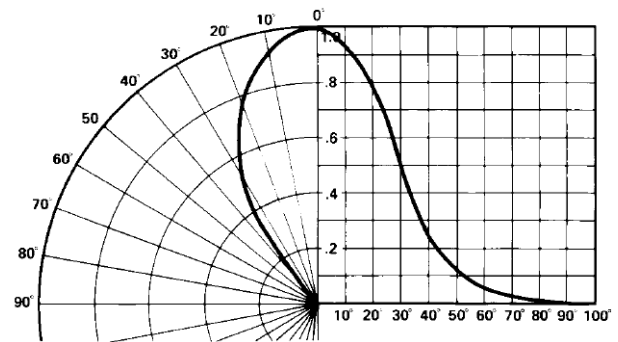

Figure 7: Relative Luminous Intensity vs. Angular Displacement, HLMP-D155

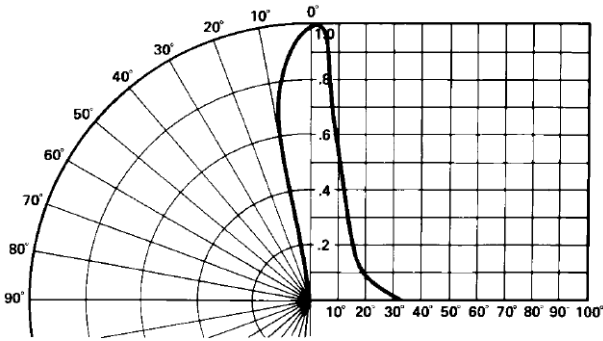
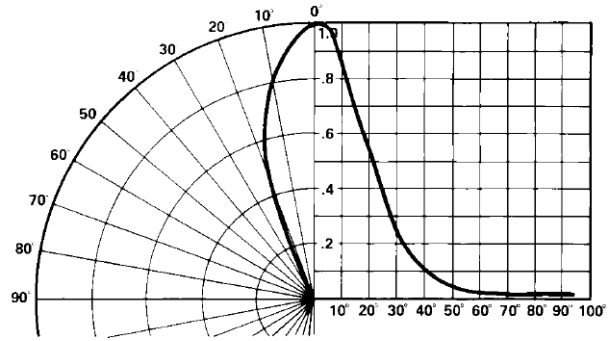

Figure 8: Relative Luminous Intensity vs. Angular Displacement, HLMP-K155



Precautions

Lead Forming

- The leads of an LED lamp may be preformed or cut to length prior to insertion and soldering on PC board.
- For better control, use the proper tool to precisely form and cut the leads to applicable length rather than doing it manually.
- If manual lead cutting is necessary, cut the leads after the soldering process. The solder connection forms a mechanical ground that prevents mechanical stress due to lead cutting from traveling into the LED package. Use this method for the hand soldering operation, because the excess lead length also acts as small heat sink.

Soldering and Handling

- Take care during the PCB assembly and soldering process to prevent damage to the LED component.
- The LED component may be effectively hand soldered to the PCB. However, do this under unavoidable circumstances, such as rework. The closest manual soldering distance of the soldering heat source (soldering iron’s tip) to the body is 1.59 mm. Soldering the LED using soldering iron tip closer than 1.59 mm might damage the LED.

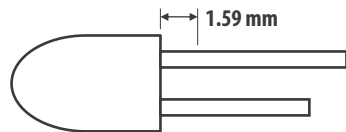

- Apply ESD precautions on the soldering station and personnel to prevent ESD damage to the LED component that is ESD sensitive. Refer to Broadcom application note AN 1142 for details. The soldering iron used must have a grounded tip to ensure electrostatic charge is properly grounded.
- Recommended soldering condition.

| | Wave Soldering ^{a, b} | Manual Solder Dipping |
|----------------------|--------------------------------|-----------------------|
| Pre-heat Temperature | 105°C max. | — |
| Pre-heat Time | 60s max. | — |
| Peak Temperature | 250°C max. | 260°C max. |
| Dwell Time | 3s max. | 5s max. |

- The preceding conditions refer to measurement with a thermocouple mounted at the bottom of the PCB.
- Use only bottom pre-heaters to reduce thermal stress experienced by the LED.

- Set and maintain wave soldering parameters according to the recommended temperature and dwell time. Perform daily checks on the soldering profile to ensure that it always conforms to the recommended soldering conditions.

NOTE:

1. PCBs with different size and design (component density) will have a different heat mass (heat capacity). This might cause a change in temperature experienced by the board if the same wave soldering setting is used. Therefore, recalibrate the soldering profile again before loading a new type of PCB.
2. Take extra precautions during wave soldering to ensure that the maximum wave temperature does not exceed 250°C and the solder contact time does not exceed 3s. Over-stressing the LED during the soldering process might cause premature failure to the LED due to delamination.
 - Loosely fit any alignment fixture that is being applied during wave soldering and do not apply weight or force on the LED. Use non-metal material because it will absorb less heat during the wave soldering process.
 - At elevated temperature, the LED is more susceptible to mechanical stress. Therefore, allow the PCB to cool down to room temperature prior to handling, which includes removal of alignment fixture or pallet.
 - If the PCB board contains both through-hole (TH) LED and other surface-mount components, solder surface-mount components on the top side of the PCB. If the surface mount must be on the bottom side, solder these components using reflow soldering prior to the insertion of the TH LED.

- The recommended PC board plated through holes (PTH) size for LED component leads follows.

| | LED Component Lead Size | Diagonal | Plated Through-Hole Diameter |
|------------------------------|---------------------------------------|-------------------------|---|
| Lead size (typ.) | 0.45 × 0.45 mm (0.018 × 0.018 in.) | 0.636 mm (0.025 in.) | 0.98 to 1.08 mm (0.039 to 0.043 in.) |
| Dambar shear-off area (max.) | 0.65 mm (0.026 in.) | 0.919 mm (0.036 in.) | |
| Lead size (typ.) | 0.50 × 0.50 mm (0.020 × 0.020 in.) | 0.707 mm (0.028 in.) | 1.05 to 1.15 mm (0.041 to 0.045 in.) |
| Dambar shear-off area (max.) | 0.70 mm (0.028 in.) | 0.99 mm (0.039 in.) | |

- Oversizing the PTH can lead to a twisted LED after clinching. On the other hand under sizing the PTH can cause difficulty inserting the TH LED.

Refer to application note AN5334 for more information about soldering and handling of TH LED lamps.

Figure 9: Example of Wave Soldering Temperature Profile for TH LED

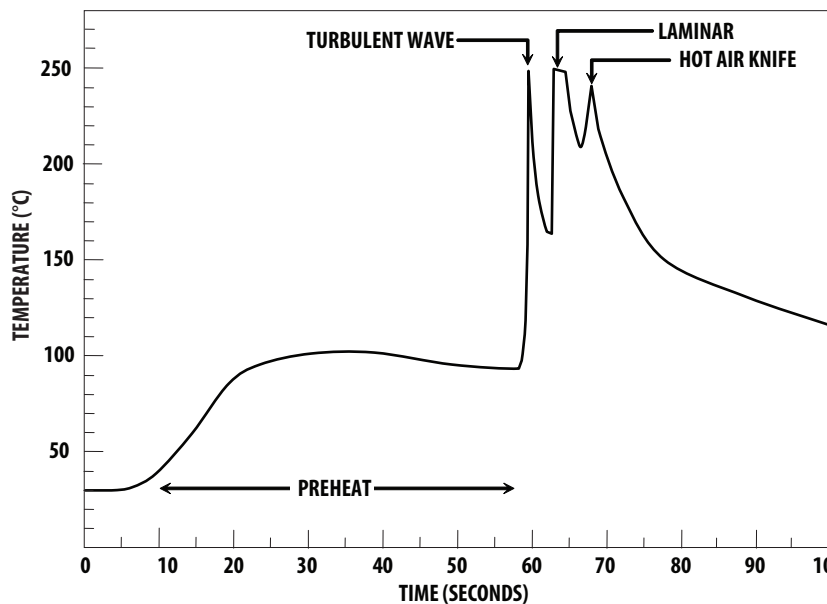

Recommended solder:
 Sn63 (Leaded solder alloy)
 SAC305 (Lead free solder alloy)

Flux: Rosin flux

Solder bath temperature:
 245°C ± 5°C (maximum peak temperature = 250°C)

Dwell time: 1.5s – 3.0s (maximum = 3 seconds)

Note: Allow for board to be sufficiently cooled to room temperature before exerting mechanical force.

Recommended solder:
 Sn63 (Leaded solder alloy)
 SAC305 (Lead free solder alloy)

Flux: Rosin flux

Solder bath temperature:
 245°C ± 5°C (maximum peak temperature = 250°C)

Dwell time: 1.5s – 3.0s (maximum = 3 seconds)











Note: Allow for board to be sufficiently cooled to room temperature before exerting mechanical force.

Packaging Label

Mother Label (Available on Packaging Box of Ammo Pack and Shipping Box)

| | |
|--|--|
|  | |
| (1P) Item: Part Number  | STANDARD LABEL LS0002 RoHS Compliant e3 max temp 250C |
| (1T) Lot: Lot Number  | (Q) QTY: Quantity  |
| LPN:  | CAT: Intensity Bin  |
| (9D)MFG Date: Manufacturing Date  | BIN: Color Bin |
| <hr/> | |
| (P) Customer Item:  | |
| (V) Vendor ID:  | (9D) Date Code: Date Code  |
| <hr/> | |
| DeptID:  | Made In: Country of Origin  |

Baby Label (Only Available on Bulk Packaging)

| | |
|--|--|
|  | |
| Lamps Baby Label | |
| RoHS Compliant e3 max temp 250C | |
| (1P) PART #: Part Number  | |
| (1T) LOT #: Lot Number  | |
| (9D)MFG DATE: Manufacturing Date  | QUANTITY: Packing Quantity  |
| C/O: Country of Origin | |
| <hr/> | |
| Customer P/N:  | CAT: Intensity Bin  |
| Supplier Code:  | BIN: Color Bin  |
| | DATECODE: Date Code  |

Broadcom, the pulse logo, Connecting everything, Avago Technologies, Avago, and the A logo are among the trademarks of Broadcom and/or its affiliates in the United States, certain other countries, and/or the EU.

Copyright © 2015–2021 Broadcom. All Rights Reserved.

The term “Broadcom” refers to Broadcom Inc. and/or its subsidiaries. For more information, please visit www.broadcom.com.

Broadcom reserves the right to make changes without further notice to any products or data herein to improve reliability, function, or design. Information furnished by Broadcom is believed to be accurate and reliable. However, Broadcom does not assume any liability arising out of the application or use of this information, nor the application or use of any product or circuit described herein, neither does it convey any license under its patent rights nor the rights of others.

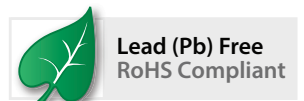

Mouser Electronics

Authorized Distributor

Click to View Pricing, Inventory, Delivery & Lifecycle Information:

Broadcom Limited:

[HLMP-D150](#) [HLMP-D150-C0002](#) [HLMP-D150-C00B2](#) [HLMP-D155](#) [HLMP-D155-F0001](#) [HLMP-D155-F0002](#) [HLMP-K150](#) [HLMP-K150-C0002](#) [HLMP-K150-C00A1](#) [HLMP-K155](#) [HLMP-K155-D0002](#)