

3-350820-2 ✓ ACTIVE

Ultra-Fast | Ultra-Fast 250

TE Internal #: 3-350820-2

Quick Disconnects, Receptacle, 16 – 14 AWG Wire Size, 1.31 – 2.08 mm<sup>2</sup> Wire Size, Mating Tab Width 6.35 mm [.25 in], Straight, Brass, Ultra-Fast 250

[View on TE.com >](#)



Terminals & Splices > Quick Disconnects

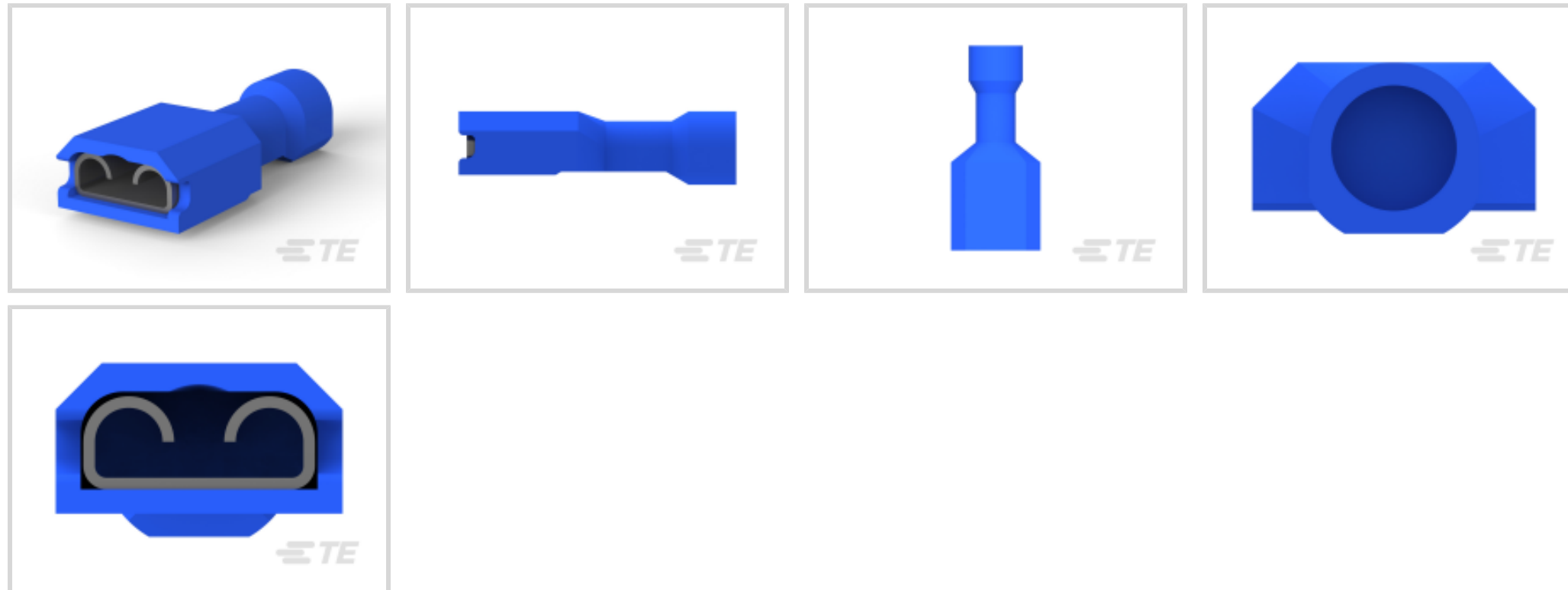

Quick Disconnect Terminal Type: **Receptacle**

Wire Size: 1.31 – 2.08 mm<sup>2</sup>

Mating Tab Width: 6.35 mm [.25 in]

Mating Tab Thickness: .81 mm [.032 in]

## Features

### Product Type Features

Terminal Features	Wire Stop
Insertion Force	Normal

### Configuration Features

Connection Capacity	Single
Compatible With Wire & Cable Type	Discrete Wire

### Electrical Characteristics

Voltage Rating	600 V
----------------	-------

### Body Features

Insulation Material	Nylon
---------------------	-------

### Contact Features

Quick Disconnect Terminal Type	Receptacle
Mating Tab Width	6.35 mm [.25 in]
Mating Tab Thickness	.81 mm [.032 in]
Terminal Orientation	Straight



Contact Base Material	Brass
Terminal Plating Material	Tin
Crimp Type	F-Crimp
Barrel Type	Closed

### Termination Features

Product Terminates To	Wire & Cable
-----------------------	--------------

### Mechanical Attachment

Wire Insulation Support	With
Mating Retention Type	Dimple

### Dimensions

Terminal Material Thickness	.41 mm[.016 in]
Product Length	21.75 mm[.855 in]
Compatible Insulation Diameter Range	4.06 mm[.16 in]
Wire Size	1.31 – 2.08 mm <sup>2</sup>

### Usage Conditions

Insulation Option	Fully Insulated
Operating Temperature Range	-40 – 110 °C[-40 – 230 °F]

### Industry Standards

Compatible With Agency/Standards Products	UL
UL Flammability Rating	UL 94V-2

### Packaging Features

Packaging Quantity	1000
Packaging Method	Loose Piece/Carton

### Other

Barrel Color	Blue
--------------	------

### Product Compliance

[For compliance documentation, visit the product page on TE.com>](#)

EU RoHS Directive 2011/65/EU	Compliant
EU ELV Directive 2000/53/EC	Compliant
China RoHS 2 Directive MIIT Order No 32, 2016	No Restricted Materials Above Threshold
EU REACH Regulation (EC) No. 1907/2006	



Current ECHA Candidate List: JAN 2024  
(240)  
Candidate List Declared Against: JAN 2024  
(240)  
Does not contain REACH SVHC

Halogen Content  
Low Halogen - Br, Cl, F, I < 900 ppm per homogenous material. Also BFR/CFR/PVC Free

Solder Process Capability  
Not applicable for solder process capability

Product Compliance Disclaimer

This information is provided based on reasonable inquiry of our suppliers and represents our current actual knowledge based on the information they provided. This information is subject to change. The part numbers that TE has identified as EU RoHS compliant have a maximum concentration of 0.1% by weight in homogenous materials for lead, hexavalent chromium, mercury, PBB, PBDE, DBP, BBP, DEHP, DIBP, and 0.01% for cadmium, or qualify for an exemption to these limits as defined in the Annexes of Directive 2011/65/EU (RoHS2). Finished electrical and electronic equipment products will be CE marked as required by Directive 2011/65/EU. Components may not be CE marked. Additionally, the part numbers that TE has identified as EU ELV compliant have a maximum concentration of 0.1% by weight in homogenous materials for lead, hexavalent chromium, and mercury, and 0.01% for cadmium, or qualify for an exemption to these limits as defined in the Annexes of Directive 2000/53/EC (ELV). Regarding the REACH Regulation, the information TE provides on SVHC in articles for this part number is based on the latest European Chemicals Agency (ECHA) 'Guidance on requirements for substances in articles' posted at this URL: <https://echa.europa.eu/guidance-documents/guidance-on-reach>

### Compatible Parts

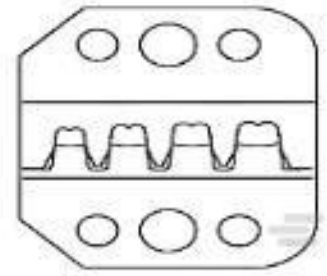

TE Part # 58628-2  
PROCIMP DIESET 26-14 ULTRAFAST



TE Part # 58628-1  
PROCIMP T&D 26-14 ULTRAFAST



TE Part # 90391-3  
DIES ULTRA-FAST FASTON 16-14 DIE SET



TE Part # 2217481-1  
KIT, BTLI, SDE CLOSED HEAD



TE Part # 2217481-2  
KIT, BTLI, SDE CLOSED HEAD

Also in the Series | **Ultra-Fast 250**



Automotive Connector Caps & Covers (1)



Automotive Housings(5)



Quick Disconnects(49)

## Customers Also Bought

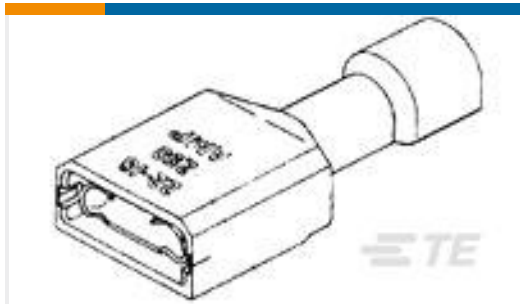

TE Part #3-350816-2  
ULTRAFAST 187 ASSY REC 16-14  
TPBR LP

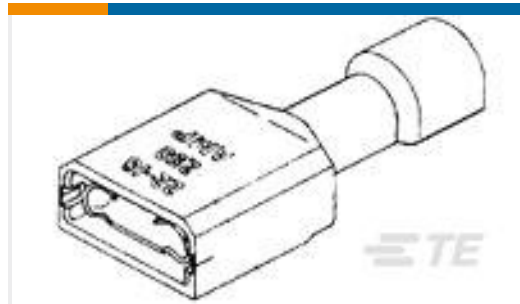

TE Part #3-520125-2  
ULTRAFAST 187 ASSY REC 16-14  
TPBR LP



TE Part #7-1971772-2  
PTL 1X2 CAP PANEL MT HITEMP KEY  
C BLK



TE Part #1217186-1  
CLUSTER BLOCK HOUSING  
C BLK

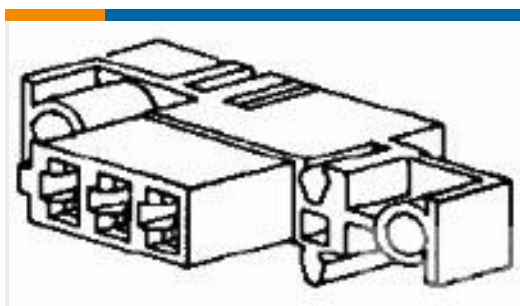

TE Part #1-480252-0  
FF 187 REC HSG 3P NYLON NAT



TE Part #2019862-1  
MV240-95

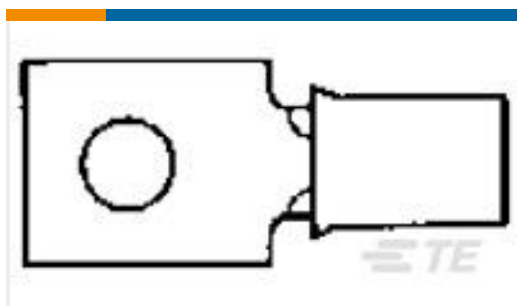

TE Part #31691  
BUDGET RECT 16-14 4



TE Part #302563  
RETAINING PIN

## Documents

### Product Drawings

[ULTRAFAST 250 ASSY REC 16-14 TPBR LP](#)

English

### CAD Files

[3D PDF](#)

3D

Customer View Model

[ENG\\_CVM\\_CVM\\_3-350820-2\\_J.2d\\_dxf.zip](#)

English

Customer View Model

[ENG\\_CVM\\_CVM\\_3-350820-2\\_J.3d\\_igs.zip](#)

English

Customer View Model

[ENG\\_CVM\\_CVM\\_3-350820-2\\_J.3d\\_stp.zip](#)

English

By downloading the CAD file I accept and agree to the [Terms and Conditions](#) of use.



---

## Datasheets & Catalog Pages

### Ultra-Fast and Ultra Fast Plus

English

---

## Product Specifications

### Application Specification

English

### Application Specification

English

---

## Agency Approvals

### UL

English