

## Type CRGP Series

### Key Features

#### Key Features

Small size and light weight

Suitable for both wave and reflow soldering techniques

Supplied on tape

Pulse Rated

7 different package sizes

Terminal finish matte Sn over Ni

AEC-Q200 Compliant



TE Connectivity is pleased to introduce this SMD Pulse withstand thick film Chip resistor, suitable for auto placement in volume and for most applications.

Available in five different packages and supplied on tape and reel for automatic insertion processes. Standard values – E24 Series and now AEC-Q200 Qualified

### Characteristics – Electrical

| Type                  | CRGP0402       | CRGP0603 | CRGP0805 | CRGP1206 |
|-----------------------|----------------|----------|----------|----------|
| Power Rating @ 70°C   | 0.125W         | 0.25W    | 0.33W    | 0.5W     |
| Max. Working Voltage  | 50V            | 50V      | 150V     | 200V     |
| Max. Overload Voltage | 100V           | 100V     | 300V     | 400V     |
| Dielectric Withstand  | 100V           | 300V     | 500V     | 500V     |
| Temperature Range     | -55°C ~ +155°C |          |          |          |
| Ambient Temperature   | 70°C           |          |          |          |

| Type                  | CRGP1210       | CRGP2010 | CRGP2512 |
|-----------------------|----------------|----------|----------|
| Power Rating @ 70°C   | 0.75W          | 1.25W    | 2W       |
| Max. Working Voltage  | 200V           | 400V     | 500V     |
| Max. Overload Voltage | 500V           | 800V     | 1000V    |
| Dielectric Withstand  | 500V           | 500V     | 500V     |
| Temperature Range     | -55°C ~ +155°C |          |          |
| Ambient Temperature   | 70°C           |          |          |

## Power derating curve

Power rating based on continuous load operation in ambient temperature of 70°C. For resistors operated in ambient temperatures above 70°C, power rating must be derated in accordance with this curve.

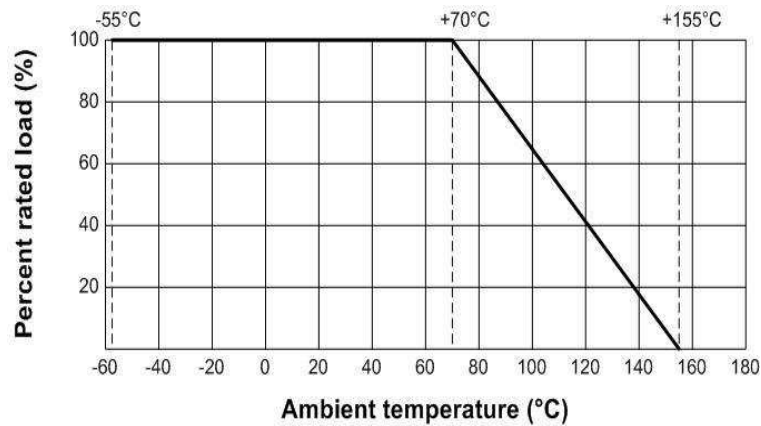

## Dimensions:

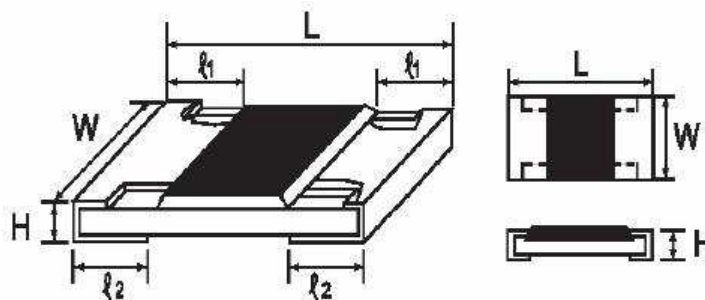

| Type     | Dimension (mm) |                    |           |           |           |
|----------|----------------|--------------------|-----------|-----------|-----------|
|          | L              | W                  | H         | ℓ1        | ℓ2        |
| CRGP0402 | 1.10±0.10      | 0.50±0.05          | 0.35±0.05 | 0.20±0.10 | 0.25±0.10 |
| CRGP0603 | 1.60±0.10      | 0.80±0.10          | 0.45±0.10 | 0.30±0.20 | 0.30±0.20 |
| CRGP0805 | 2.00±0.15      | 1.25+0.15<br>-0.10 | 0.55±0.10 | 0.40±0.20 | 0.40±0.20 |
| CRGP1206 | 3.10±0.15      | 1.55+0.15<br>-0.10 | 0.55±0.10 | 0.45±0.20 | 0.45±0.20 |
| CRGP1210 | 3.10±0.10      | 2.60±0.20          | 0.55±0.10 | 0.55±0.25 | 0.50±0.20 |
| CRGP2010 | 5.00±0.10      | 2.50±0.20          | 0.55±0.10 | 0.60±0.25 | 0.50±0.20 |
| CRGP2512 | 6.35±0.10      | 3.20±0.20          | 0.55±0.10 | 0.60±0.25 | 0.50±0.20 |

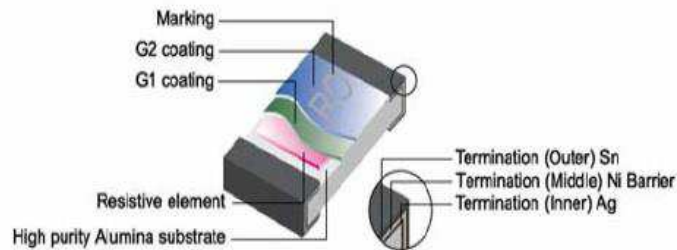
**Construction:****Power Rating and Resistance Range:**

| Type     | Power Rating @ 70°C | Tolerance | Resistance Range | Standard Series           |
|----------|---------------------|-----------|------------------|---------------------------|
| CRGP0402 | 0.125W              | ±1%       | 1R0 – 10M        | E24<br>E96 by negotiation |
|          |                     | ±5%       |                  |                           |
| CRGP0603 | 0.25W               | ±1%       | 1R0 – 10M        | E24<br>E96 by negotiation |
|          |                     | ±5%       |                  |                           |
| CRGP0805 | 0.33W               | ±1%       | 1R0 – 10M        | E24<br>E96 by negotiation |
|          |                     | ±5%       |                  |                           |
| CRGP1206 | 0.5W                | ±1%       | 1R0 – 10M        | E24<br>E96 by negotiation |
|          |                     | ±5%       |                  |                           |
| CRGP1210 | 0.75W               | ±1%       | 1R0 – 10M        | E24<br>E96 by negotiation |
|          |                     | ±5%       |                  |                           |
| CRGP2010 | 1.25W               | ±1%       | 1R0 – 10M        | E24<br>E96 by negotiation |
|          |                     | ±5%       |                  |                           |
| CRGP2512 | 2W                  | ±1%       | 1R0 – 10M        | E24<br>E96 by negotiation |
|          |                     | ±5%       |                  |                           |

**Marking:**

E24 series 0603 – 2512 3 Digits – first two digits denote significant figures of resistance and third digit denotes number of zeros thereafter. EG

|  |     |  |
|--|-----|--|
|  | 222 |  |
|--|-----|--|

 = 
 2K2



Marking for E96 Series 0805 – 2512 4 digits – First three digits denote significant figures of resistance and fourth digit denotes number of zeros thereafter. EG.

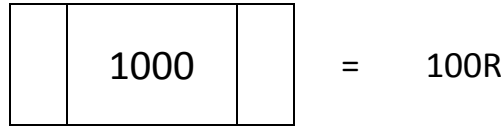

For ohmic values below 100R letter “R” denotes decimal point. EG

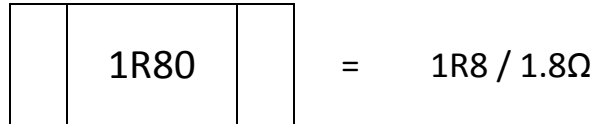

0402 size chips are not marked

0603 E96 3 digit marking.

**Mutiplier Code :**

| Code       | A               | B               | C               | D               | E               | F               | G               | H               | X                | Y                | Z                |
|------------|-----------------|-----------------|-----------------|-----------------|-----------------|-----------------|-----------------|-----------------|------------------|------------------|------------------|
| Multiplier | 10 <sup>0</sup> | 10 <sup>1</sup> | 10 <sup>2</sup> | 10 <sup>3</sup> | 10 <sup>4</sup> | 10 <sup>5</sup> | 10 <sup>6</sup> | 10 <sup>7</sup> | 10 <sup>-1</sup> | 10 <sup>-2</sup> | 10 <sup>-3</sup> |

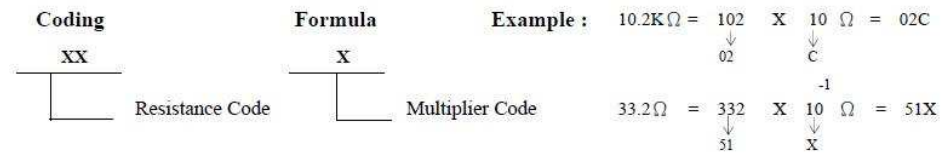

| Value | Code | Value | Code | Value | Code | Value | Code | Value | Code |
|-------|------|-------|------|-------|------|-------|------|-------|------|
| 100   | 01   | 162   | 21   | 261   | 41   | 422   | 61   | 681   | 81   |
| 102   | 02   | 165   | 22   | 267   | 42   | 432   | 62   | 698   | 82   |
| 105   | 03   | 169   | 23   | 274   | 43   | 442   | 63   | 715   | 83   |
| 107   | 04   | 174   | 24   | 280   | 44   | 453   | 64   | 732   | 84   |
| 110   | 05   | 178   | 25   | 287   | 45   | 464   | 65   | 750   | 85   |
| 113   | 06   | 182   | 26   | 294   | 46   | 475   | 66   | 768   | 86   |
| 115   | 07   | 187   | 27   | 301   | 47   | 487   | 67   | 787   | 87   |
| 118   | 08   | 191   | 28   | 309   | 48   | 499   | 68   | 806   | 88   |
| 121   | 09   | 196   | 29   | 316   | 49   | 511   | 69   | 825   | 89   |
| 124   | 10   | 200   | 30   | 324   | 50   | 523   | 70   | 845   | 90   |
| 127   | 11   | 205   | 31   | 332   | 51   | 536   | 71   | 866   | 91   |
| 130   | 12   | 210   | 32   | 340   | 52   | 549   | 72   | 887   | 92   |
| 133   | 13   | 215   | 33   | 348   | 53   | 562   | 73   | 909   | 93   |
| 137   | 14   | 221   | 34   | 357   | 54   | 576   | 74   | 931   | 94   |
| 140   | 15   | 226   | 35   | 365   | 55   | 590   | 75   | 953   | 95   |
| 143   | 16   | 232   | 36   | 374   | 56   | 604   | 76   | 976   | 96   |
| 147   | 17   | 237   | 37   | 383   | 57   | 619   | 77   |       |      |
| 150   | 18   | 243   | 38   | 392   | 58   | 634   | 78   |       |      |
| 154   | 19   | 249   | 39   | 402   | 59   | 649   | 79   |       |      |
| 158   | 20   | 255   | 40   | 412   | 60   | 665   | 80   |       |      |

### Pulse withstand capacity

The single impulse graph is the result of 50 impulses of rectangular shape applied at one-minute intervals. The limit of acceptance was a shift in resistance of less than 1% from the initial value. The power applied was subject to the restrictions of the maximum permissible impulse voltage graph shown.

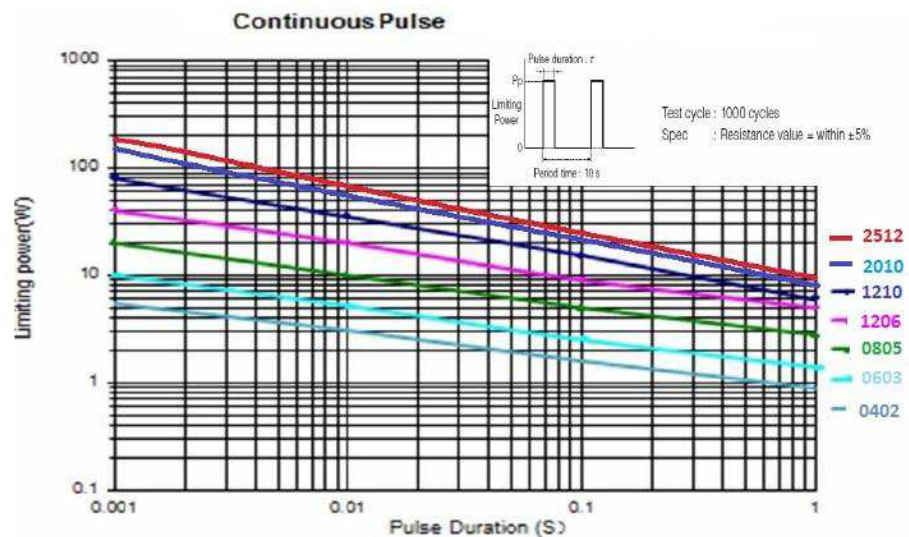
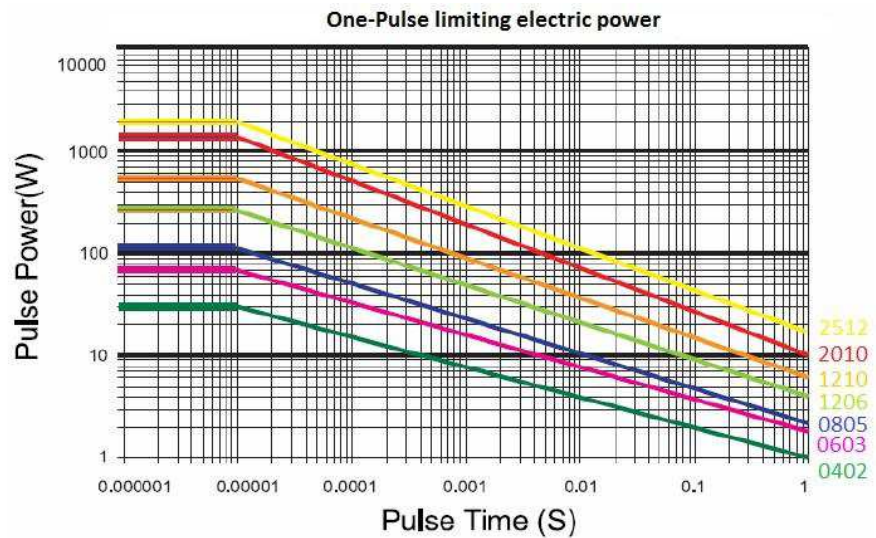

**Performance Specification:**

| Characteristic                      | Limits  | Test Methods<br>(AEC-Q200)  |
|-------------------------------------|---|---|
| Operational life                    | ±5%, ±10%, ±20%:<br>±(3%+0.1Ω)Max.                                  | 125°C, at35% of operating power,<br>1000H(1.5 hours<br>“ON”, 0.5 hour “OFF”). (MIL-STD-202)   |
| Temperature Coefficient             | 1Ω~10Ω : ± 400 PPM/°C<br>10.1Ω~10MΩ : ± 100 PPM/°C                  | Natural resistance change per temp.<br>degree centigrade<br>R1-R2<br>----- x10 <sup>6</sup> (PPM/°C)<br>R1(t2-t1)<br>R1 resistance value at room temperature (t1)<br>R2 Resistance value at room temperature +100°C (t2)            |
| External Visual                     | No Mechanical Damage  | Electrical test not required. Inspect device construction, marking and workmanship (MIL-STD-883 Method 2009)  |
| Physical Dimensions                 | Reference 2.0 Dimension Standards                                   | Verify physical dimensions to the applicable device detail specification. Note: User(s) and Suppliers spec. Electrical test not required. (JESD22 MH Method JB-100)   |
| Resistance to Solvent               | Marking Unsmearred  | Note: Add Aqueous wash chemical – OKEM Clean or equivalent.<br>Do not use banned solvents.<br>( MIL-STD-202 Method 215)   |
| Terminal Strength                   | Not Broken  | Force of 1.8kg for 60 seconds.<br>(JIS-C-6429)  |
| Terminal Bending                    | ± (1.0% ±0.05Ω) Max.  | Twist of Test Board :<br>Y/X = 5/90 mm for 10 seconds<br>(Sub-clause 4.33)  |
| High Temperature Exposure (Storage) | ±(1%+0.1Ω)max   | 1000hrs. @T=155°C.Unpowered.<br>Measurement at 24±2 hours after test conclusion. (MIL-STD-202 Method 108)   |
| Temperature Cycling                 | Resistance change rate is<br>±5%, ±10%, ±20%: ±<br>(1.0%+0.1Ω) Max. | 1000 Cycles (-55°C to +155°C).<br>Measurement at 24±2 hours after test conclusion.<br>(JESD22 Method JA-104)  |
| Solderability                       | 95% coverage Min.   | Test temperature of solder : 245 ± 3 °C<br>Dwell time in solder : 2 ~ 3 seconds<br>(Sub-clause 4.17)<br>For both leaded & SMD. Electrical test not required.<br>95% coverage Min. Magnification 50X.<br>Conditions:<br>( J-STD-002) |
| Soldering Heat                      | Resistance change rate is<br>±(1.0%+0.05Ω) Max.                     | Dip the resistor into a solder bath having a temperature of 260°C±3°C and hold it for 10±1 seconds<br>(Sub-clause 4.18)   |
| Insulation Resistance               | 1,000MΩ or more   | Apply 500V DC between protective coating and termination for 1 min, then measure<br>(Sub-clause 5.6)  |

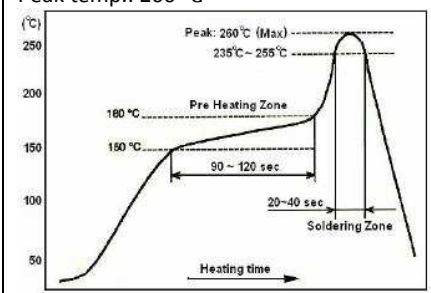
| Characteristic               | Limits   | Test Methods<br>(AEC-Q200)  |
|------------------------------|--|---|
| Solder Temp. Reference       | Electrical characteristics shall be satisfied without distinct deformation in appearance.<br>(95% coverage Min.) | Wave soldering condition: (2 cycles Max.)<br>Pre-heat : 100 ~ 120 °C, 30 ± 5 sec.<br>Suggestion solder temp.: 235 ~ 255 °C, 10 seconds max.<br>Peak temp.: 260 °C<br>Reflow soldering condition: (2 cycles Max.)<br>Pre-heat : 150 ~ 180 °C, 90 ~ 120 sec.<br>Suggestion solder temp.: 235 ~ 255 °C, 20 ~ 40 sec.<br>Peak temp.: 260 °C<br> |
| Short term overload          | Resistance change rate is<br>±5% : ±(2.0% ±0.1Ω) Max.<br>±1% : ±(1.0% ±0.1Ω) Max.                                | Permanent resistance change after the application of a potential of 2.5 times RCWV for 5 seconds<br>Sub-clause 4.13   |
| Dielectric Withstand Voltage | No evidence of flashover, mechanical damage, arcing or insulation breakdown.                                     | Apply 500V AC between protective coating and termination for 1 minute<br>(Sub-clause 4.7)   |
| Humidity                     | Resistance change rate is:<br>± (3.0% + 0.1Ω) Max.   | Temporary resistance change after 240 hours exposure in a humidity test chamber controlled at 40±2°C and 90-95% relative humidity<br>(Sub-clause 4.24)  |
| Load Life In Humidity        | Resistance change rate is:<br>±5% : ±(3.0% ±0.1Ω) Max.<br>±1% : ±(1.0% ±0.1Ω) Max.                               | Resistance change after 1,000 hours (1.5 hours "on", 0.5 hour "off") at RCWV in a humidity chamber controlled at 40°C ± 2°C and 90 to 95 % relative humidity.<br>(Sub-clause 4.24.2.1)  |
| Load Life                    | Resistance change rate is:<br>±5% : ±(3.0% ±0.1Ω) Max.<br>±1% : ±(1.0% ±0.1Ω) Max.                               | Permanent resistance change after 1,000 hours operating at RCWV, with duty cycle of (1.5 hours "on", 0.5 hour "off") at 70°C ± 2°C ambient<br>(Sub-clause 4.25.1)   |

### Packaging Specification

#### Paper taping

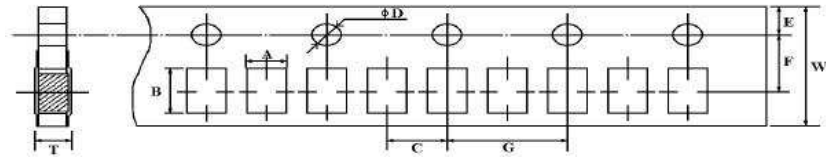

| Type | A ±  | B ±  | C ± | ØD +0.1<br>-0 | E ±  | F ± | G ± | W ± | T ±  |
|------|------|------|-----|---------------|------|-----|-----|-----|------|
| 0402 | 0.65 | 1.15 | 2.0 | 1.5           | 1.75 | 3.5 | 4.0 | 8.0 | 0.45 |
| 0603 | 1.10 | 1.90 | 2.0 | 1.5           | 1.75 | 3.5 | 4.0 | 8.0 | 0.67 |
| 0805 | 1.65 | 2.40 | 2.0 | 1.5           | 1.75 | 3.5 | 4.0 | 8.0 | 0.81 |
| 1206 | 2.00 | 3.60 | 2.0 | 1.5           | 1.75 | 3.5 | 4.0 | 8.0 | 0.81 |
| 1210 | 2.80 | 3.50 | 2.0 | 1.5           | 1.75 | 3.5 | 4.0 | 8.0 | 0.75 |

#### Embossed Taping

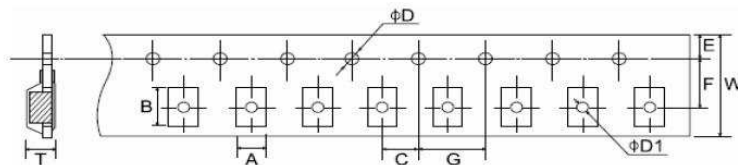

| Type | A    | B    | C     | ØD         | ØD1        | E    | F     | G    | W    | T ± |
|------|------|------|-------|------------|------------|------|-------|------|------|-----|
|      | ±0.2 | ±0.2 | ±0.05 | +0.1<br>-0 | +0.1<br>-0 | ±0.1 | ±0.05 | ±0.1 | ±0.2 | 0.1 |
| 2010 | 2.90 | 5.60 | 2.0   | 1.5        | 1.5        | 1.75 | 5.5   | 4.0  | 12.0 | 1.0 |
| 2512 | 3.50 | 6.70 | 2.0   | 1.5        | 1.5        | 1.75 | 5.5   | 4.0  | 12.0 | 1.0 |

Peeling strength of cover tape:

Test condition: 0.1 to 0.7 N at a peel off speed of 300mm / min.

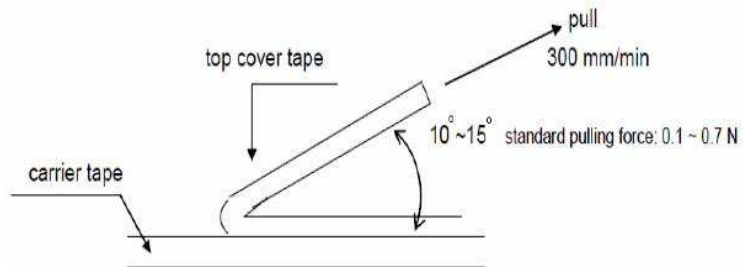



## Reel Dimensions (mm):

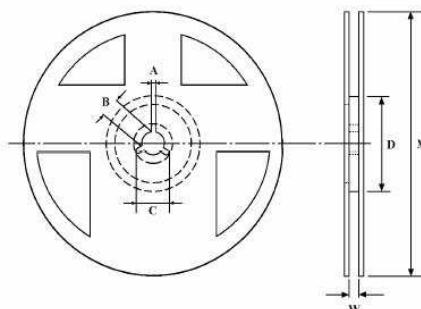

| Type | Tape     | Reel Qty | A ± 0.5 | B ± 0.5 | C ± 0.5 | D ± 1 | M ± 2 | W ± 1 |
|------|----------|----------|---------|---------|---------|-------|-------|-------|
| 0402 | Paper    | 10,000   | 2       | 13      | 21      | 60    | 178   | 10    |
| 0603 | Paper    | 5,000    | 2       | 13      | 21      | 60    | 178   | 10    |
| 0805 | Paper    | 5,000    | 2       | 13      | 21      | 60    | 178   | 10    |
| 1206 | Paper    | 5,000    | 2       | 13      | 21      | 60    | 178   | 10    |
| 1210 | Paper    | 5,000    | 2       | 13      | 21      | 60    | 178   | 10    |
| 2010 | Embossed | 4,000    | 2       | 13      | 21      | 60    | 178   | 13.8  |
| 2512 | Embossed | 4,000    | 2       | 13      | 21      | 60    | 178   | 13.8  |

**Environment Related Substance**

This product complies to EU RoHS directive, EU PAHs directive, EU PFOS directive and Halogen free.

**Ozone layer depleting substances.**

Ozone depleting substances are not used in our manufacturing process of this product.

This product is not manufactured using Chloro fluorocarbons (CFCs), Hydrochlorofluorocarbons (HCFCs), Hydrobromofluorocarbons (HBFCs) or other ozone depleting substances in any phase of the manufacturing process.

**Storage Condition**

The performance of these products, including the solderability, is guaranteed for a year from the date of arrival at your company, provided that they remain packed as they were when delivered and stored at a temperature of  $25^{\circ}\text{C} \pm 10^{\circ}\text{C}$  and a relative humidity of  $60\%RH \pm 10\%RH$ , chemical and dust free atmosphere

Even within the above guarantee periods, do not store these products in the following conditions otherwise, their electrical performance and/or solderability may be deteriorated, and the packaging materials (e.g. taping materials) may be deformed or deteriorated, resulting in mounting failures.

1. In salty air or in air with a high concentration of corrosive gas, such as  $\text{Cl}_2$ ,  $\text{H}_2\text{S}$ ,  $\text{NH}_3$ ,  $\text{SO}_2$ , or  $\text{NO}_2$
2. In direct sunlight

**Solder Profile**

Wave soldering condition: (2 cycles Max.)

Pre-heat : 100 ~ 120 °C, 30 ± 5 sec.

Suggestion solder temp.: 235 ~ 255 °C, 10 seconds

Peak temp.: 260 °C

Reflow soldering condition: (2 cycles Max.)

Pre-heat : 150 ~ 180 °C, 90 ~ 120 sec.

Suggestion solder temp.: 235 ~ 255 °C, 20 ~ 40 seconds

Peak temp.: 260 °C

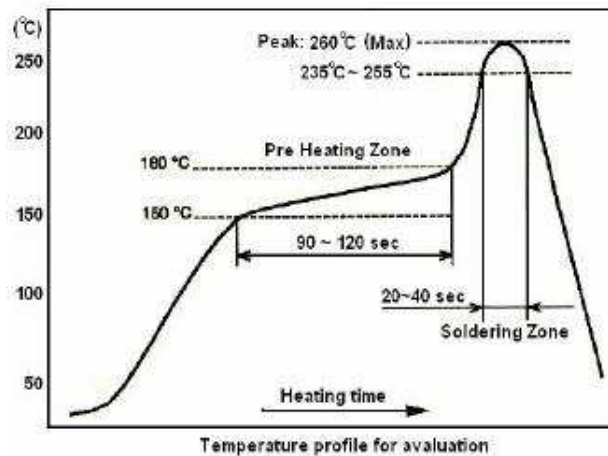

Hand Soldering condition: The Soldering iron tip should be less than 300°C and maximum contact time should be 5 seconds

**How To Order**

| CRGP  | 0603 | J                  | 10K                     |
|---|------|--------------------|-------------------------|
| Common Part                                     | Size | Tolerance          | Resistance Value        |
| CRGP – Pulse Withstand Thick Film Chip Resistor | 0402 | F - ±1%<br>J - ±5% | 1 ohm (1Ω) 1R0          |
|   | 0603 |                    | 1K ohm (1000Ω) 1K0      |
|   | 0805 |                    | 100K ohm (100000Ω) 100K |
|   | 1206 |                    |                         |
|   | 1210 |                    |                         |
|   | 2010 |                    |                         |
|   | 2512 |                    | 1M ohm (1000000Ω) 1M0   |

# Mouser Electronics

Authorized Distributor

Click to View Pricing, Inventory, Delivery & Lifecycle Information:

[TE Connectivity:](#)

[CRGP0603F1M0](#)