

Features:

- Precision tolerances to $\pm 0.01\%$
- TCR down to $\pm 2 \text{ ppm}/^\circ\text{C}$
- Wide resistance value range
- RoHS compliant, REACH compliant, lead free, and halogen free
- AEC-Q200 compliant



Electrical Specifications – Precision Thin Film Chip Resistor

Type/Code	Power Rating ⁽²⁾ (W) @ 70°C	Maximum Working Voltage (V) ⁽¹⁾	Maximum Overload Voltage (V)	TCR (ppm/°C)	Ohmic Range (Ω) and Tolerance						
					0.01%	0.05%	0.1%	0.25%	0.5%	1%	
RNCF0201	0.05	15	30	± 10	-		22 - 5K*				
				± 15			22 - 75K				
				± 25							
				± 50							
RNCF0402	0.063	50	100	± 10	12.1K - 20K		-				
				± 15			-				
				± 25			-		4.02 - 4.64, 261K - 511K		
				± 50							
	0.1	50	100	± 10	49.9 - 12K		49.9 - 100K				
				± 15							
				± 25			-	49.9 - 12K	4.7 - 255K		
				± 50							
RNCF0603	0.1	75	150	± 10	24.9 - 100K	4.7 - 332K	4.7 - 511K				
				± 15	24.9 - 100K	4.7 - 9.88	1 - 9.76, 336K - 1M				
				± 25	-		10 - 332K				
				± 50							
	0.166	100	150	± 25	-		10 - 332K				
				± 50							
				± 10			-	517K - 1M	-		
				± 15			-	505K - 1M	1.02M - 2M		
RNCF0805	0.125	150	300	± 10	24.9 - 200K	4.7 - 511K	4.7 - 1M				
				± 15	24.9 - 200K	4.7 - 9.88	505K - 1M				
				± 25	-		10 - 499K				
				± 50							
	0.25	150	300	± 25	-		1.02M - 1.5M				
				± 50			-		1.02M - 2.5M		
				± 10					24.9 - 499K	4.7 - 1M	
				± 15			24.9 - 499K	1 - 9.76			
0.33	200	400	± 25	-		4.7 - 1M					
			± 50								
			± 10			-		1.02M - 1.5M			
			± 15								

* Subject to higher MOQ.

(1) Lesser of $\sqrt{P \cdot R}$ or maximum working voltage.

(2) For lower power ratings, contact Stackpole.

Electrical Specifications – Precision Thin Film Chip Resistor (cont.)

Type/Code	Power Rating ⁽²⁾ (W) @ 70°C	Maximum Working Voltage (V) ⁽¹⁾	Maximum Overload Voltage (V)	TCR (ppm/°C)	Ohmic Range (Ω) and Tolerance					
					0.01%	0.05%	0.1%	0.25%	0.5%	1%
RNCF1210	0.25	150	300	± 25	-		1.02M - 2.5M			
				± 50						
	0.33	200	400	± 10	24.9 - 499K	4.7 - 1M				
				± 15	24.9 - 499K					1 - 1M
			± 25							
			± 50							
RNCF2010	0.25	150	300	± 25	-		1.02M - 3M			
				± 50						
	0.33	200	400	± 10	24.9 - 499K	4.7 - 1M				
				± 15	24.9 - 499K					1 - 1M
			± 25							
			± 50							
RNCF2512	0.5	150	300	± 10	2.05K - 499K		2.05K - 1M			
				± 15						
				± 25	-	2.05K - 1M	2.05K - 3M			
				± 50						
	0.75	200	400	± 10	24.9 - 2K	4.7 - 2K	4.7 - 2K	1 - 2K		
				± 15	24.9 - 2K	4.7 - 2K	101 - 2K			101 - 2K
				± 25						
				± 50						
1	200	400	± 25	-		4.7 - 100	1 - 100			
			± 50							

(1) Lesser of $\sqrt{P \cdot R}$ or maximum working voltage.

(2) For lower power ratings, contact Stackpole.

Electrical Specifications – Ultra-Precision Thin Film Chip Resistor

Type/Code	Power Rating ⁽²⁾ (W) @ 70°C	Maximum Working Voltage (V) ⁽¹⁾	Maximum Overload Voltage (V)	TCR (ppm/°C)	Ohmic Range (Ω) and Tolerance					
					0.01%	0.05%	0.1%	0.25%	0.5%	1%
RNCF0402	0.1	50	100	± 2	49.9 - 4.99K		-			
				± 5	49.9 - 20K					
RNCF0603	0.1	75	150	± 2	24.9 - 15K		-			
				± 5	24.9 - 59K					
RNCF0805	0.125	150	300	± 2	24.9 - 30K		-			
				± 5	24.9 - 150K					
RNCF1206	0.25	200	400	± 2	24.9 - 49.9K		-			
				± 5	24.9 - 300K					
RNCF1210	0.33	200	400	± 2	24.9 - 49.9K		-			
				± 5	24.9 - 300K					
RNCF2010	0.25	150	300	± 2	51K - 100K		-			
				± 2	24.9 - 49.9K		-			
	0.33	200	400	± 5	24.9 - 300K					
RNCF2512	0.5	150	300	± 2	24.9 - 100K		-			
				± 5	24.9 - 300K					

(1) Lesser of $\sqrt{P \cdot R}$ or maximum working voltage.

(2) For lower power ratings, contact Stackpole.

Mechanical Specifications

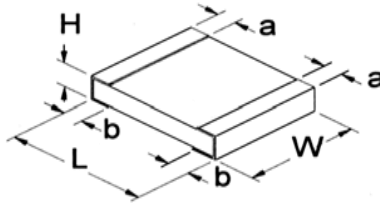

Type/Code	Weight (mg) (ref.)	L Body Length	W Body Width	H Body Height	a Top Termination	b Bottom Termination	Unit
RNCF0201	0.17	0.023 ± 0.003	0.011 ± 0.002	0.009 ± 0.002	0.005 ± 0.002	0.006 ± 0.002	inches
		0.58 ± 0.07	0.29 ± 0.06	0.23 ± 0.05	0.12 ± 0.05	0.15 ± 0.05	mm
RNCF0402	0.54	0.039 ± 0.002	0.020 ± 0.002	0.012 ± 0.002	0.008 ± 0.004	0.008 ± 0.004	inches
		1.00 ± 0.05	0.50 ± 0.05	0.30 ± 0.05	0.20 ± 0.10	0.20 ± 0.10	mm
RNCF0603	1.8	0.061 ± 0.004	0.031 ± 0.004	0.018 ± 0.004	0.012 ± 0.008	0.012 ± 0.008	inches
		1.55 ± 0.10	0.80 ± 0.10	0.45 ± 0.10	0.30 ± 0.20	0.30 ± 0.20	mm
RNCF0805	4.7	0.079 ± 0.006	0.049 ± 0.006	0.022 ± 0.004	0.012 ± 0.008	0.016 ± 0.008	inches
		2.00 ± 0.15	1.25 ± 0.15	0.55 ± 0.10	0.30 ± 0.20	0.40 ± 0.20	mm
RNCF1206	8.6	0.120 ± 0.006	0.061 ± 0.006	0.022 ± 0.004	0.017 ± 0.008	0.014 ± 0.010	inches
		3.05 ± 0.15	1.55 ± 0.15	0.55 ± 0.10	0.42 ± 0.20	0.35 ± 0.25	mm
RNCF1210	10.0	0.122 ± 0.006	0.094 ± 0.006	0.022 ± 0.004	0.016 ± 0.008	0.022 ± 0.010	inches
		3.10 ± 0.15	2.40 ± 0.15	0.55 ± 0.10	0.40 ± 0.20	0.55 ± 0.25	mm
RNCF2010	23.6	0.193 ± 0.006	0.094 ± 0.006	0.022 ± 0.004	0.024 ± 0.012	0.020 ± 0.010	inches
		4.90 ± 0.15	2.40 ± 0.15	0.55 ± 0.10	0.60 ± 0.30	0.50 ± 0.25	mm
RNCF2512	38.1	0.248 ± 0.006	0.122 ± 0.006	0.022 ± 0.004	0.024 ± 0.012	0.020 ± 0.010	inches
		6.30 ± 0.15	3.10 ± 0.15	0.55 ± 0.10	0.60 ± 0.30	0.50 ± 0.25	mm

Performance Characteristics

Test	Test Method	Test Specification		Test Condition
		Tol. ≤ 0.05%	Tol. > 0.05%	
Temperature coefficient of Resistance (T.C.R.)	MIL-STD-202 Method 304	As specified.		+25 / -55 / +25 / +125 / +25°C
Short Time Overload	JIS-C-5201-1 4.13	Δ R ± 0.05%	Δ R ± 0.2%	RCWV * 2.5 or Max. overload voltage whichever is lower for 5 seconds
Insulation Resistance	MIL-STD-202 Method 302	> 9999M Ω		
Endurance	MIL-STD-202 Method 108A	Δ R ± 0.05%	Δ R ± 0.2%	70 ± 2°C, RCWV for 1000 hours with 1.5 hours "ON" and 0.5 hour "OFF"
		Δ R ± 0.5% for high power rating		
		0201 ≤ 7K Ω: Δ R ± 0.2% 0201 > 7K Ω: Δ R ± 0.5%		
Damp Heat with Load	MIL-STD-202 Method 103B	Δ R ± 0.05%	Δ R ± 0.3%	40 ± 2°C, 90 ~ 95% R.H. RCWV for 1000 hours with 1.5 hours "ON" and 0.5 hour "OFF"
		Δ R ± 0.5% for high power rating		
Bending Strength	JIS-C-5201-1 4.33	Δ R ± 0.05%	Δ R ± 0.1%	Bending amplitude for 10 seconds. 2010 and 2512 sizes: 2 mm Other sizes: 3 mm
Solderability	MIL-STD-202 Method 208H	95% min. coverage		245 ± 5°C for 3 seconds
Resistance to Soldering Heat	MIL-STD-202 Method 210E	Δ R ± 0.05%	Δ R ± 0.1%	260 ± 5°C for 10 seconds
Dielectric Withstand Voltage	MIL-STD-202 Method 301	by type		Max. overload voltage for 1 minute
Low Temperature Operation	JIS-C-5201-1 4.36	Δ R ± 0.05%	Δ R ± 0.2%	1 hour, - 65°C, followed by 45 minutes of RCWV
		Δ R ± 0.5% for high power rating		
High Temperature Exposure	MIL-STD-202 Method 108	Δ R ± 0.5%		+155°C for 1000 hours

RCWV (Rated Continuous Working Voltage) = √(P*R) or Max. Operating Voltage, whichever is lower

Recommended storage conditions: 60 ~ 82°F. Humidity < 80% R.H.

Operating temperature range is -55°C to + 155°C

Power Derating Curve:

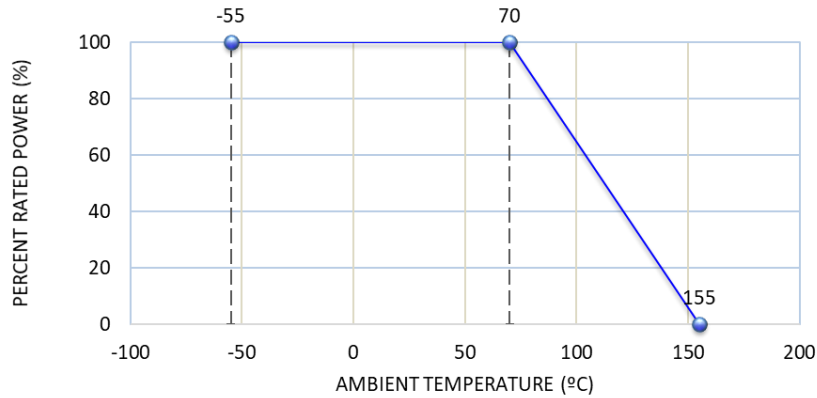

Reel Specifications

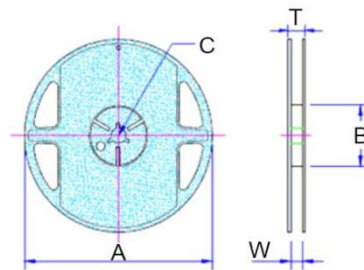

Type/Code	A	B	C	W	T	Unit
RNCF0201	7.008 ± 0.039	2.362 ± 0.039	0.531 ± 0.028	0.374 ± 0.039	0.453 ± 0.039	inches
	178.00 ± 1.00	60.00 ± 1.00	13.50 ± 0.70	9.50 ± 1.00	11.50 ± 1.00	mm
RNCF0402	7.008 ± 0.039	2.362 ± 0.039	0.531 ± 0.028	0.374 ± 0.039	0.453 ± 0.039	inches
	178.00 ± 1.00	60.00 ± 1.00	13.50 ± 0.70	9.50 ± 1.00	11.50 ± 1.00	mm
RNCF0603	7.008 ± 0.039	2.362 ± 0.039	0.531 ± 0.028	0.374 ± 0.039	0.453 ± 0.039	inches
	178.00 ± 1.00	60.00 ± 1.00	13.50 ± 0.70	9.50 ± 1.00	11.50 ± 1.00	mm
RNCF0805	7.008 ± 0.039	2.362 ± 0.039	0.531 ± 0.028	0.374 ± 0.039	0.453 ± 0.039	inches
	178.00 ± 1.00	60.00 ± 1.00	13.50 ± 0.70	9.50 ± 1.00	11.50 ± 1.00	mm
RNCF1206	7.008 ± 0.039	2.362 ± 0.039	0.531 ± 0.028	0.374 ± 0.039	0.453 ± 0.039	inches
	178.00 ± 1.00	60.00 ± 1.00	13.50 ± 0.70	9.50 ± 1.00	11.50 ± 1.00	mm
RNCF1210	7.008 ± 0.039	2.362 ± 0.039	0.531 ± 0.028	0.374 ± 0.039	0.453 ± 0.039	inches
	178.00 ± 1.00	60.00 ± 1.00	13.50 ± 0.70	9.50 ± 1.00	11.50 ± 1.00	mm
RNCF2010	7.008 ± 0.039	2.362 ± 0.039	0.531 ± 0.028	0.531 ± 0.039	0.610 ± 0.039	inches
	178.00 ± 1.00	60.00 ± 1.00	13.50 ± 0.70	13.50 ± 1.00	15.50 ± 1.00	mm
RNCF2512	7.008 ± 0.039	2.362 ± 0.039	0.531 ± 0.028	0.531 ± 0.039	0.610 ± 0.039	inches
	178.00 ± 1.00	60.00 ± 1.00	13.50 ± 0.70	13.50 ± 1.00	15.50 ± 1.00	mm

Packaging Specifications – Paper Tape

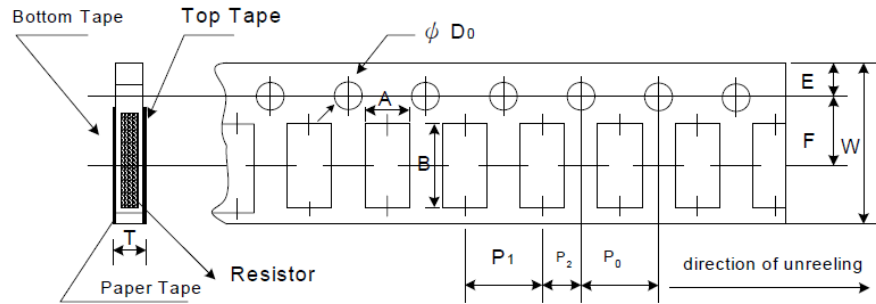

Type/Code	A	B	W	E	F	Unit
RNCF0201	0.016 ± 0.002	0.028 ± 0.002	0.315 ± 0.004	0.069 ± 0.002	0.138 ± 0.002	inches
	0.40 ± 0.05	0.70 ± 0.05	8.00 ± 0.10	1.75 ± 0.05	3.50 ± 0.05	mm
RNCF0402	0.028 ± 0.002	0.046 ± 0.002	0.315 ± 0.004	0.069 ± 0.002	0.138 ± 0.002	inches
	0.70 ± 0.05	1.16 ± 0.05	8.00 ± 0.10	1.75 ± 0.05	3.50 ± 0.05	mm
RNCF0603	0.043 ± 0.002	0.075 ± 0.002	0.315 ± 0.004	0.069 ± 0.002	0.138 ± 0.002	inches
	1.10 ± 0.05	1.90 ± 0.05	8.00 ± 0.10	1.75 ± 0.05	3.50 ± 0.05	mm
RNCF0805	0.063 ± 0.002	0.093 ± 0.002	0.315 ± 0.004	0.069 ± 0.020	0.138 ± 0.002	inches
	1.60 ± 0.05	2.37 ± 0.05	8.00 ± 0.10	1.75 ± 0.50	3.50 ± 0.05	mm
RNCF1206	0.079 ± 0.002	0.140 ± 0.002	0.315 ± 0.004	0.069 ± 0.002	0.138 ± 0.002	inches
	2.00 ± 0.05	3.55 ± 0.05	8.00 ± 0.10	1.75 ± 0.05	3.50 ± 0.05	mm
RNCF1210	0.108 ± 0.002	0.134 ± 0.002	0.315 ± 0.004	0.069 ± 0.002	0.138 ± 0.002	inches
	2.75 ± 0.05	3.40 ± 0.05	8.00 ± 0.10	1.75 ± 0.05	3.50 ± 0.05	mm
Type/Code	P0	P1	P2	D0	T	Unit
RNCF0201	0.157 ± 0.004	0.079 ± 0.002	0.079 ± 0.002	0.061 ± 0.001	0.017 ± 0.001	inches
	4.00 ± 0.10	2.00 ± 0.05	2.00 ± 0.05	1.55 ± 0.03	0.42 ± 0.02	mm
RNCF0402	0.157 ± 0.004	0.079 ± 0.002	0.079 ± 0.002	0.061 ± 0.002	0.016 ± 0.001	inches
	4.00 ± 0.10	2.00 ± 0.05	2.00 ± 0.05	1.55 ± 0.05	0.40 ± 0.03	mm
RNCF0603	0.157 ± 0.004	0.157 ± 0.004	0.079 ± 0.002	0.061 ± 0.002	0.024 ± 0.001	inches
	4.00 ± 0.10	4.00 ± 0.10	2.00 ± 0.05	1.55 ± 0.05	0.60 ± 0.03	mm
RNCF0805	0.157 ± 0.004	0.157 ± 0.004	0.079 ± 0.002	0.061 ± 0.002	0.030 ± 0.002	inches
	4.00 ± 0.10	4.00 ± 0.10	2.00 ± 0.05	1.55 ± 0.05	0.75 ± 0.05	mm
RNCF1206	0.157 ± 0.004	0.157 ± 0.004	0.079 ± 0.002	0.061 ± 0.002	0.030 ± 0.002	inches
	4.00 ± 0.10	4.00 ± 0.10	2.00 ± 0.05	1.55 ± 0.05	0.75 ± 0.05	mm
RNCF1210	0.157 ± 0.002	0.157 ± 0.004	0.079 ± 0.002	0.063 ± 0.004	0.030 ± 0.002	inches
	4.00 ± 0.05	4.00 ± 0.10	2.00 ± 0.05	1.60 ± 0.10	0.75 ± 0.05	mm

Peel Force of Top Cover Tape

The peel speed shall be about 300 mm / min ± 5%
The peel force of top cover tape shall be between 8gf to 60gf

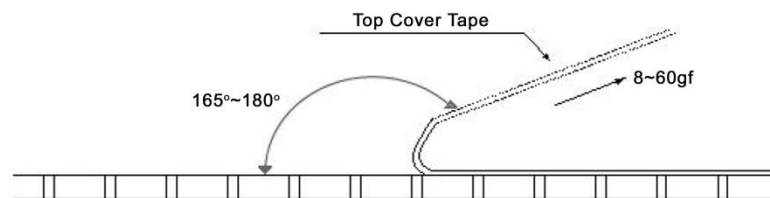

Packaging Specifications – Plastic Tape

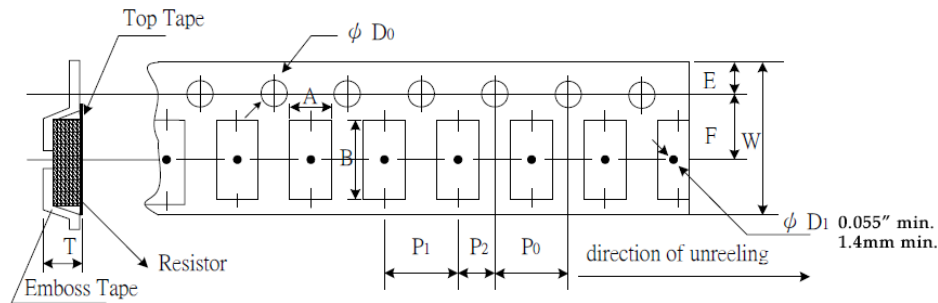

Type/Code	A	B	W	E	F	Unit
RNCF2010	0.112 ± 0.004	0.215 ± 0.004	0.472 ± 0.004	0.069 ± 0.004	0.217 ± 0.002	inches
	2.85 ± 0.10	5.45 ± 0.10	12.00 ± 0.10	1.75 ± 0.10	5.50 ± 0.05	mm
RNCF2512	0.134 ± 0.004	0.262 ± 0.004	0.472 ± 0.004	0.069 ± 0.004	0.217 ± 0.002	inches
	3.40 ± 0.10	6.65 ± 0.10	12.00 ± 0.10	1.75 ± 0.10	5.50 ± 0.05	mm
Type/Code	P0	P1	P2	D0	T	Unit
RNCF2010	0.157 ± 0.002	0.157 ± 0.004	0.079 ± 0.002	0.059 ± 0.004	0.039 ± 0.008	inches
	4.00 ± 0.05	4.00 ± 0.10	2.00 ± 0.05	1.50 ± 0.10	1.00 ± 0.20	mm
RNCF2512	0.157 ± 0.002	0.157 ± 0.004	0.079 ± 0.002	0.059 ± 0.004	0.039 ± 0.008	inches
	4.00 ± 0.05	4.00 ± 0.10	2.00 ± 0.05	1.50 ± 0.10	1.00 ± 0.20	mm

Peel Force of Top Cover Tape

The peel speed shall be about 300 mm / min ± 5%
The peel force of top cover tape shall be between 20gf to 80gf

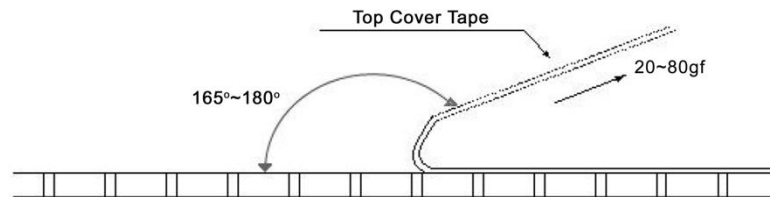

Recommended Pad Layout

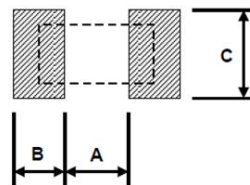

Type/Code	A	B	C	Unit
RNCF0201	0.010	0.012	0.016 ± 0.008	inches
	0.25	0.30	0.40 ± 0.20	mm
RNCF0402	0.020	0.020	0.024 ± 0.008	inches
	0.50	0.50	0.60 ± 0.20	mm
RNCF0603	0.031	0.039	0.035 ± 0.008	inches
	0.80	1.00	0.90 ± 0.20	mm
RNCF0805	0.039	0.039	0.053 ± 0.008	inches
	1.00	1.00	1.35 ± 0.20	mm

Recommended Pad Layout (cont.)

Type/Code	A	B	C	Unit
RNCF1206	0.079	0.045	0.067 ± 0.008	inches
	2.00	1.15	1.70 ± 0.20	mm
RNCF1210	0.079	0.045	0.098 ± 0.008	inches
	2.00	1.15	2.50 ± 0.20	mm
RNCF2010	0.142	0.055	0.098 ± 0.008	inches
	3.60	1.40	2.50 ± 0.20	mm
RNCF2512	0.193	0.063	0.122 ± 0.008	inches
	4.90	1.60	3.10 ± 0.20	mm

Recommended Solder Profile

This information is intended as a reference for solder profiles for Stackpole resistive components. These profiles should be compatible with most soldering processes. These are only recommendations. Actual numbers will depend on board density, geometry, packages used, etc., especially those cells labeled with “*”.

100% Matte Tin / RoHS Compliant Terminations

Soldering iron recommended temperatures: 330°C to 350°C with minimum duration.
Maximum number of reflow cycles is 3.

Wave Soldering

Description	Maximum	Recommended	Minimum
Preheat Time	80 seconds	70 seconds	60 seconds
Temperature Diff.	140°C	120°C	100°C
Solder Temp.	260°C	250°C	240°C
Dwell Time at Max	10 seconds	5 seconds	*
Ramp DN (°C/sec)	N/A	N/A	N/A

Temperature Diff. = Difference between final preheat stage and soldering stage.

Convection IR Reflow

Description	Maximum	Recommended	Minimum
Ramp Up (°C/sec)	3°C/sec	2°C/sec	*
Dwell Time > 217°C	150 seconds	90 seconds	60 seconds
Solder Temp.	260°C	245°C	*
Dwell Time at Max.	30 seconds	15 seconds	10 seconds
Ramp DN (°C/sec)	6°C/sec	3°C/sec	*

Recommended Lead Free Resistor Reflow Profile

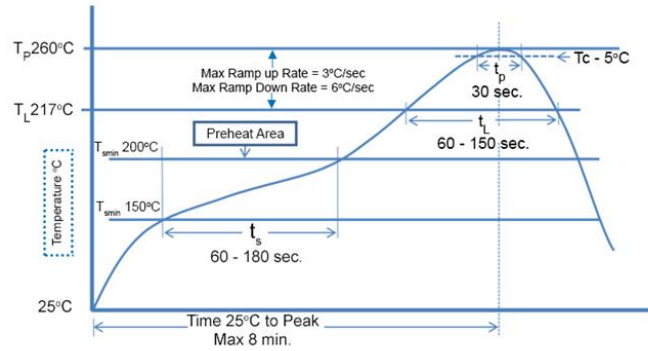

Profile Feature	Pb-Free Assembly
Preheat:	
Min. temperature (T _{smin})	150°C
Max. temperature (T _{smax})	200°C
Preheating time (t _s) from T _{smin} to T _{smax}	60-120 seconds
Ramp-up rate (T _L to T _P)	3°C/second max
Liquidous temperature (T _L)	217°C
Time (t _L) maintained above T _L	60-150 seconds
Min. peak temperature (T _p min)	235°C
Max. peak temperature (T _p max)	260°C
Time (t _p) within 5°C of the specified classification temperature (T _c)	30 seconds max.
Ramp-down rate (T _L to T _P)	6°C/second max.
Time 25°C to peak temperature	8 minutes max.

Part Marking

E96 and E24 Values 0805-2512

The nominal resistance is marked on the surface of the overcoating with the use of four character markings. Values below 100Ω will use "R" as the decimal holder.

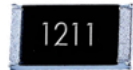
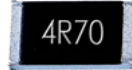

E24 Values 0603

The nominal resistance is marked on the surface of the overcoating with the use of three character markings. Values below 10Ω will use "R" as the decimal holder.

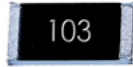
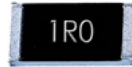

E96 Values for 0603

A two character number is assigned to each standard R-Value (E96) as shown in the chart below.

This is followed by one alpha character which is used as a multiplier.

Each letter from "Y" - "F" represents a specific multiplier.

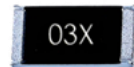

Alpha Character = Multiplier		Chip Marking	Value
Y = 0.1	C = 1000	01B =	10.0 x 100 = 1 KΩ
X = 1	D = 10000	25C =	17.8 x 1000 = 17.8 KΩ
A = 10	E = 100000	93D =	90.9 x 10000 = 909 KΩ
B = 100	F = 1000000		

E96

#	R-Value	#	R-Value	#	R-Value	#	R-Value	#	R-Value	#	R-Value
01	10.0	17	14.7	33	21.5	49	31.6	65	46.4	81	68.1
02	10.2	18	15.0	34	22.1	50	32.4	66	47.5	82	69.8
03	10.5	19	15.4	35	22.6	51	33.2	67	48.7	83	71.5
04	10.7	20	15.8	36	23.2	52	34.0	68	49.9	84	73.2
05	11.0	21	16.2	37	23.7	53	34.8	69	51.1	85	75.0
06	11.3	22	16.5	38	24.3	54	35.7	70	52.3	86	76.8
07	11.5	23	16.9	39	24.9	55	36.5	71	53.6	87	78.7
08	11.8	24	17.4	40	25.5	56	37.4	72	54.9	88	80.6
09	12.1	25	17.8	41	26.1	57	38.3	73	56.2	89	82.5
10	12.4	26	18.2	42	26.7	58	39.2	74	57.6	90	84.5
11	12.7	27	18.7	43	27.4	59	40.2	75	59.0	91	86.6
12	13.0	28	19.1	44	28.0	60	41.2	76	60.4	92	88.7
13	13.3	29	19.6	45	28.7	61	42.2	77	61.9	93	90.9
14	13.7	30	20.0	46	29.4	62	43.2	78	63.4	94	93.1
15	14.0	31	20.5	47	30.1	63	44.2	79	64.9	95	95.3
16	14.3	32	21.0	48	30.9	64	45.3	80	66.5	96	97.6

Note: 0201 and 0402 resistors are not marked. E192 values that are not shared E96 or E24 values are not marked.

RoHS Compliance

Stackpole Electronics has joined the worldwide effort to reduce the amount of lead in electronic components and to meet the various regulatory requirements now prevalent, such as the European Union's directive regarding "Restrictions on Hazardous Substances" (RoHS 3). As part of this ongoing program, we periodically update this document with the status regarding the availability of our compliant components. All our standard part numbers are compliant to EU Directive 2011/65/EU of the European Parliament as amended by Directive (EU) 2015/863/EU as regards the list of restricted substances.

RoHS Compliance Status						
Standard Product Series	Description	Package / Termination Type	Standard Series RoHS Compliant	Lead-Free Termination Composition	Lead-Free Mfg. Effective Date (Std Product Series)	Lead-Free Effective Date Code (YY/WW)
RNCF	Precision Thin Film Surface Mount Chip Resistor	SMD	YES	100% Matte Sn over Ni	May-04	04/18

"Conflict Metals" Commitment

We at Stackpole Electronics, Inc. are joined with our industry in opposing the use of metals mined in the "conflict region" of the eastern Democratic Republic of the Congo (DRC) in our products. Recognizing that the supply chain for metals used in the electronics industry is very complex, we work closely with our own suppliers to verify to the extent possible that the materials and products we supply do not contain metals sourced from this conflict region. As such, we are in compliance with the requirements of Dodd-Frank Act regarding Conflict Minerals.

Compliance to "REACH"

We certify that all passive components supplied by Stackpole Electronics, Inc. are SVHC (Substances of Very High Concern) free and compliant with the requirements of EU Directive 1907/2006/EC, "The Registration, Evaluation, Authorization and Restriction of Chemicals", otherwise referred to as REACH. Contact us for complete list of REACH Substance Candidate List.

Environmental Policy

It is the policy of Stackpole Electronics, Inc. (SEI) to protect the environment in all localities in which we operate. We continually strive to improve our effect on the environment. We observe all applicable laws and regulations regarding the protection of our environment and all requests related to the environment to which we have agreed. We are committed to the prevention of all forms of pollution.

How to Order

R	N	C	F	0	8	0	5	D	T	E	4	K	7	5
Product Series		Size	Tolerance			Packaging				TCR		Resistance Value ⁽²⁾		
Code	Description	Code	Code	Tol	Value ⁽¹⁾	Code	Description	Size	Quantity	Code	ppm	Four characters with the multiplier used as the decimal holder. 24.9 ohm = 24R9 10 Kohm = 10K0 1 Mohm = 1M00		
RNCF	Precision Thin Film Chip Resistors	0201 0402 0603 0805 1206 1210 2010 2512	T A B C D F	0.01% 0.05% 0.1% 0.25% 0.5% 1%	E192, E96, E24 E96, E24	T K	7" Reel Paper Tape 7" Reel Plastic Tape 7" Reel Paper Tape 7" Reel Plastic Tape	0201, 0402 0603, 0805 1206, 1210 2010, 2512 0201 - 1210 2010, 2512	10000 5000 4000 1000	W Y T S E C D	2 5 10 15 25 50 100			

(1) E192 values may be subject to higher MOQ

(2) Values below 10 ohm and above 1 Mohm may be subject to higher MOQ

Mouser Electronics

Authorized Distributor

Click to View Pricing, Inventory, Delivery & Lifecycle Information:

SEI Stackpole:

[RNCF1206TKW261R](#) [RNCF1206TKW26R1](#) [RNCF1206TKW270R](#) [RNCF1206TKW27R0](#) [RNCF1206TKW294R](#)
[RNCF1206TKW2K37](#) [RNCF1206TKW2K43](#) [RNCF1206TKW2K61](#) [RNCF1206TKW2K74](#) [RNCF1206TKW2K80](#)
[RNCF1206TKW2K94](#) [RNCF1206TKW300R](#) [RNCF1206TKW30K0](#) [RNCF1206TKW30R1](#) [RNCF1206TKW31R6](#)
[RNCF1206TKW324R](#) [RNCF1206TKW340R](#) [RNCF1206TKW348R](#) [RNCF1206TKW34K8](#) [RNCF1206TKW357R](#)
[RNCF1206TKW35K7](#) [RNCF1206TKW35R7](#) [RNCF1206TKW365R](#) [RNCF1206TKW36K5](#) [RNCF1206TKW36R5](#)
[RNCF1206TKW383R](#) [RNCF1206TKW390R](#) [RNCF1206TKW392R](#) [RNCF1206TKW39K0](#) [RNCF1206TKW39K2](#)
[RNCF1206TKW3K65](#) [RNCF1206TKW3K90](#) [RNCF1206TKW40K2](#) [RNCF1206TKW42K2](#) [RNCF1206TKW442R](#)
[RNCF1206TKW46K4](#) [RNCF1206TKW475R](#) [RNCF1206TKW47K0](#) [RNCF1206TKW499R](#) [RNCF1206TKW49R9](#)
[RNCF1206TKW4K87](#) [RNCF1206TKW4K99](#) [RNCF1206TKW560R](#) [RNCF1206TKW590R](#) [RNCF1206TKW5K11](#)
[RNCF1206TKW5K23](#) [RNCF1206TKW620R](#) [RNCF1206TKW634R](#) [RNCF1206TKW69R8](#) [RNCF1206TKW6K19](#)
[RNCF1206TKW6K65](#) [RNCF1206TKW6K80](#) [RNCF1206TKW71R5](#) [RNCF1206TKW7K15](#) [RNCF1206TKW7K50](#)
[RNCF1206TKW7K68](#) [RNCF1206TKW866R](#) [RNCF1206TKW86R6](#) [RNCF1206TKW8K20](#) [RNCF1206TKW8K66](#)
[RNCF1206TKW909R](#) [RNCF1206TKW9K10](#) [RNCF1206TKW9K76](#) [RNCF1206TKY2K00](#) [RNCF1206TKY3K32](#)
[RNCF1206TKY49K9](#) [RNCF1206TTT10K0](#) [RNCF1206TTT30R1](#) [RNCF1210BKE10K0](#) [RNCF1210BKE10K5](#)
[RNCF1210BKE10R0](#) [RNCF1210BKE10R5](#) [RNCF1210BKE110K](#) [RNCF1210BKE113R](#) [RNCF1210BKE11K8](#)
[RNCF1210BKE12R0](#) [RNCF1210BKE12R1](#) [RNCF1210BKE12R4](#) [RNCF1210BKE133R](#) [RNCF1210BKE147K](#)
[RNCF1210BKE14K0](#) [RNCF1210BKE15K0](#) [RNCF1210BKE15K8](#) [RNCF1210BKE15R4](#) [RNCF1210BKE15R8](#)
[RNCF1210BKE169R](#) [RNCF1210BKE16K9](#) [RNCF1210BKE16R0](#) [RNCF1210BKE16R2](#) [RNCF1210BKE180K](#)
[RNCF1210BKE182K](#) [RNCF1210BKE18K2](#) [RNCF1210BKE18R0](#) [RNCF1210BKE18R7](#) [RNCF1210BKE1K02](#)
[RNCF1210BKE1K33](#) [RNCF1210BKE1K37](#) [RNCF1210BKE1K43](#) [RNCF1210BKE1K50](#) [RNCF1210BKE1K60](#)