

DC Film Capacitors MKT Radial Potted Type

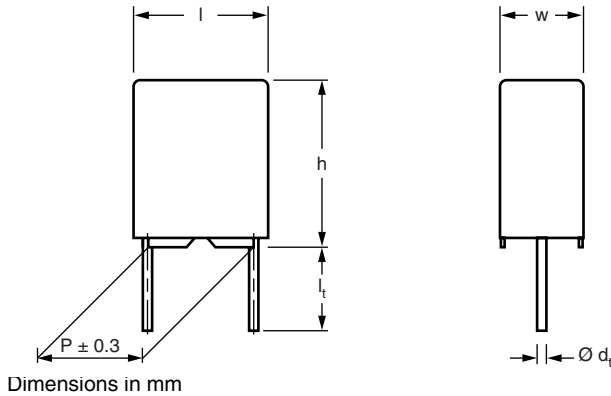

APPLICATIONS

Blocking and coupling, bypass and energy reservoir, telecom, industrial, consumer

REFERENCE STANDARDS

IEC 60384-2

MARKING

C-value; tolerance; rated voltage; manufacturer's symbol; year and week of manufacturer; manufacturer's type

DIELECTRIC

Polyester film

ELECTRODES

Metallized

CONSTRUCTION

Mono construction
Series construction for 630 V 0.00068 μ F ~ 0.0018 μ F

RATED (DC) VOLTAGE

63 V, 100 V, 250 V, 400 V, 630 V

RATED (AC) VOLTAGE

40 V, 63 V, 160 V, 220 V

FEATURES

5.08 mm lead pitch.
Supplied loose in box, taped on ammpack or reel
Compliant to RoHS directive 2002/95/EC



RoHS
COMPLIANT

ENCAPSULATION

Flame retardant plastic case and epoxy resin
(UL-class 94 V-0)

CLIMATIC TESTING CLASS ACC. TO IEC 60068-1

55/100/56 for rated voltage 63 V
55/105/56 for rated voltage > 63 V

CAPACITANCE RANGE (E12 SERIES)

0.00068 μ F to 1.5 μ F

CAPACITANCE TOLERANCE

$\pm 10 \%$, $\pm 5 \%$

LEADS

Tinned wire

RATED TEMPERATURE

85 °C

MAXIMUM APPLICATION TEMPERATURE

100 °C for rated voltage 63 V
105 °C for rated voltage > 63 V

PERFORMANCE GRADE

Grade 1 (long life)

DETAIL SPECIFICATION

For more detailed data and test requirements contact:
dc-film@vishay.com

COMPOSITION OF CATALOG NUMBER

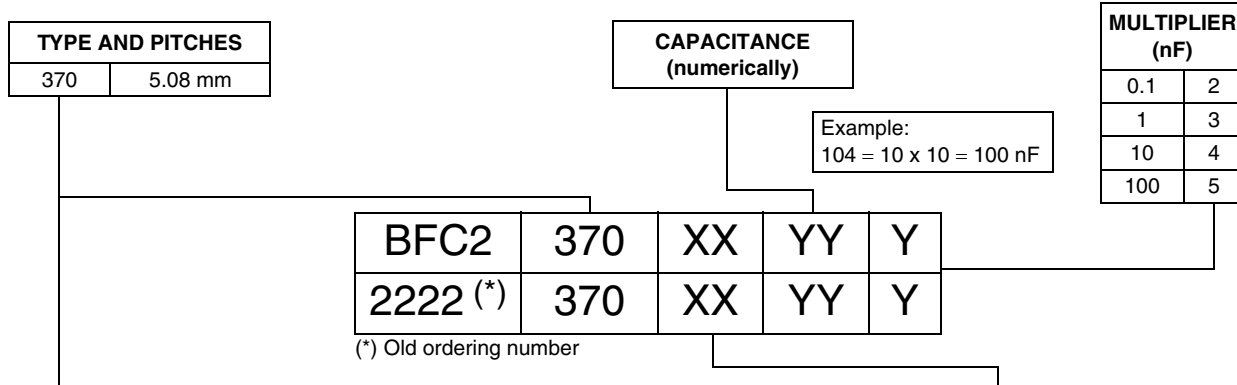

TYPE	PACKAGING	LEAD CONFIGURATION	PREFERRED TYPES				
			C-TOL.	63 V	100 V	250 V	400 V
370 (standard size)	Loose in box	Lead length 4.0 mm + 1.0 mm/- 0.5 mm	± 10 %	11	21	41	51
			± 5 %	12	22	42	52
		Lead length 26.0 mm ± 2.0 mm	± 10 %	15	25	45	55
			± 5 %	16	26	46	56
	Taped on reel (1)	H = 18.5 mm; P ₀ = 12.7 mm; Reel diameter = 356 mm	± 10 %	18	28	48	58
			± 5 %	19	29	49	59
	Ammopack (1)	H = 18.5 mm; P ₀ = 12.7 mm	± 10 %	75	85	35	65
			± 5 %	76	86	36	66
TYPE	PACKAGING	LEAD CONFIGURATION	PREFERRED TYPES				
			C-TOL.	100 V	250 V	400 V	630 V
370 (compact size)	Loose in box	Lead length 4.0 mm + 1.0 mm/- 0.5 mm	± 10 %	CE	EE	FE	GE
			± 5 %	CF	EF	FF	GF
		Lead length 26.0 mm ± 2.0 mm	± 10 %	CH	EH	FH	GH
			± 5 %	CI	EI	FI	GI
	Taped on reel (1)	H = 18.5 mm; P ₀ = 12.7 mm; Reel diameter = 356 mm	± 10 %	CL	EL	FL	GL
			± 5 %	CM	EM	FM	GM
			± 10 %	CB	EB	FB	GB
			± 5 %	CC	EC	FC	GC

Note

(1) For detailed tape specifications refer to packaging information: www.vishay.com/doc?28139 or end of catalog

SPECIFIC REFERENCE DATA (STANDARD SIZE)

DESCRIPTION	VALUE			
	at 1 kHz	at 10 kHz	at 100 kHz	
Tangent of loss angle:				
C ≤ 0.1 μF	≤ 75 x 10 ⁻⁴	≤ 130 x 10 ⁻⁴	≤ 220 x 10 ⁻⁴	
0.1 μF < C ≤ 0.47 μF	≤ 75 x 10 ⁻⁴	≤ 130 x 10 ⁻⁴	≤ 300 x 10 ⁻⁴	
0.47 μF < C ≤ 1.5 μF	≤ 75 x 10 ⁻⁴	≤ 130 x 10 ⁻⁴	-	
Rated voltage pulse slope (dU/dt) _R at	63 Vdc	100 Vdc	250 Vdc	400 Vdc
	60 V/μs	110 V/μs	330 V/μs	630 V/μs
R between leads, for C ≤ 0.33 μF	> 15 000 MΩ	> 15 000 MΩ	> 30 000 MΩ	> 30 000 MΩ
at 10 V; 1 min				
at 100 V; 1 min				
RC between leads	> 5000 s	> 5000 s		
0.33 μF < C ≤ 1.0 μF at 10 V; 1 min				
C > 1.0 μF at 10 V; 1 min				
C > 0.33 μF at 100 V; 1 min				
R between interconnecting leads and case (foil method)	> 30 000 MΩ	> 30 000 MΩ	> 30 000 MΩ	> 30 000 MΩ
Withstanding (DC) voltage (cut off current 10 mA);	100 V; 1 min	160 V; 1 min	400 V; 1 min	640 V; 1 min
Withstanding (DC) voltage between leads and case	200 V; 1 min	200 V; 1 min	500 V; 1 min	800 V; 1 min
Maximum application temperature	100 °C		105 °C	



SPECIFIC REFERENCE DATA (COMPACT SIZE)

DESCRIPTION	VALUE			
	at 1 kHz		at 10 kHz	at 100 kHz
Tangent of loss angle:				
C ≤ 0.1 μF	≤ 75 x 10 ⁻⁴		≤ 130 x 10 ⁻⁴	≤ 220 x 10 ⁻⁴
0.1 μF < C ≤ 0.47 μF	≤ 75 x 10 ⁻⁴		≤ 130 x 10 ⁻⁴	≤ 300 x 10 ⁻⁴
C > 0.47 μF	≤ 75 x 10 ⁻⁴		≤ 130 x 10 ⁻⁴	-
Rated voltage pulse slope (dU/dt) _R at	100 Vdc	250 Vdc	400 Vdc	630 Vdc
	37 V/μs	44 V/μs	200 V/μs	540 V/μs
R between leads, for C ≤ 0.33 μF at 100 V; 1 min	> 15 000 MΩ	> 30 000 MΩ	> 30 000 MΩ	> 30 000 MΩ
RC between leads C > 0.33 μF at 100 V; 1 min	> 5000 s			
R between interconnecting leads and case (foil method)	> 30 000 MΩ	> 30 000 MΩ	> 30 000 MΩ	> 30 000 MΩ
Withstanding (DC) voltage (cut off current 10 mA);	160 V; 1 min	400 V; 1 min	640 V; 1 min	1008 V; 1 min
Withstanding (DC) voltage between leads and case	200 V; 1 min	500 V; 1 min	800 V; 1 min	1260 V; 1 min
Maximum application temperature	100 °C		105 °C	

U_{Rdc} = 63 V; U_{Rac} = 40 V

C (μF)	DIMENSIONS w x h x l (mm)	MASS (g) ⁽¹⁾	CATALOG NUMBER BFC2 370 XXYYY AND PACKAGING								C-VALUE ..YYY
			AMMOPACK		LOOSE IN BOX				REEL		
			H = 18.5 mm; P ₀ = 12.7 mm		Short leads		Long leads				
			C-tol. = ± 10 %	C-tol. = ± 5 %	C-tol. = ± 10 %	C-tol. = ± 5 %	C-tol. = ± 10 %	C-tol. = ± 5 %	C-tol. = ± 10 %	C-tol. = ± 5 %	
			XX (SPQ)	XX (SPQ)	XX (SPQ)	XX (SPQ)	XX (SPQ)	XX (SPQ)	XX (SPQ)	XX (SPQ)	
Pitch = 5.08 ± 0.30 mm; d_t = 0.50 ± 0.05 mm											
0.056	2.5 x 6.5 x 7.2	0.18									563
0.068											683
0.082											823
0.1			75... (2000)	76... (2000)	11... (2000)	12... (2000)	15... (1000)	16... (1000)	18... (2000)	19... (2000)	104
0.12											124
0.15											154
0.18											184
0.22	3.5 x 8.0 x 7.2	0.3									224
0.27											274
0.33			75... (1500)	76... (1500)	11... (2000)	12... (2000)	15... (1000)	16... (1000)	18... (1500)	19... (1500)	334
0.39											394
0.47											474
0.56	4.5 x 9.0 x 7.2	0.42									564
0.68			75... (1000)	76... (1000)	11... (2000)	12... (2000)	15... (1000)	16... (1000)	18... (1000)	19... (1000)	684
0.82											824
1.0	6.0 x 11.0 x 7.2	0.64									105
1.2 ⁽²⁾			75... (750)	76... (750)	11... (2000)	12... (2000)	15... (1000)	16... (1000)	18... (1000)	19... (1000)	125
1.5 ⁽²⁾											155

Notes

⁽¹⁾ Weight for short lead products only

⁽²⁾ For C = 1.2 μF and C = 1.5 μF: U_{Rdc} = 50 V and U_{Rac} = 32 V

• SPQ = Standard Packing Quantity

$U_{Rdc} = 100\text{ V}$; $U_{Rac} = 63\text{ V}$ (standard size)

C (μF)	DIMENSIONS w x h x l (mm)	MASS (g) ⁽¹⁾	CATALOG NUMBER BFC2 370 XYYYY AND PACKAGING								C-VALUE ..YYY		
			AMMOPACK		LOOSE IN BOX				REEL				
			H = 18.5 mm; P ₀ = 12.7 mm		Short leads		Long leads						
			C-tol. = $\pm 10\%$	C-tol. = $\pm 5\%$	C-tol. = $\pm 10\%$	C-tol. = $\pm 5\%$	C-tol. = $\pm 10\%$	C-tol. = $\pm 5\%$	C-tol. = $\pm 10\%$	C-tol. = $\pm 5\%$			
			XX (SPQ)	XX (SPQ)	XX (SPQ)	XX (SPQ)	XX (SPQ)	XX (SPQ)	XX (SPQ)	XX (SPQ)	XX (SPQ)		
Pitch = 5.08 mm \pm 0.30 mm; d_t = 0.50 mm \pm 0.05 mm													
0.001	2.5 x 6.5 x 7.2	0.18									102		
0.0012												122	
0.0015												152	
0.0018												182	
0.0022												222	
0.0027												272	
0.0033												332	
0.0039												392	
0.0047												472	
0.0056												562	
0.0068												682	
0.0082												822	
0.010					85... (2000)	86... (2000)	21... (2000)	22... (2000)	25... (1000)	26... (1000)	28... (2000)	29... (2000)	103
0.012													123
0.015													153
0.018													183
0.022													223
0.027											273		
0.033											333		
0.039											393		
0.047											473		
0.056											563		
0.068											683		
0.082											823		
0.10											104		
0.12	3.5 x 8.0 x 7.2	0.30									124		
0.15												154	
0.18					85... (1500)	86... (1500)	21... (2000)	22... (2000)	25... (1000)	26... (1000)	28... (1500)	29... (1500)	184
0.22	4.5 x 9.0 x 7.2	0.42									224		
0.27												274	
0.33					85... (1000)	86... (1000)	21... (2000)	22... (2000)	25... (1000)	26... (1000)	28... (1000)	29... (1000)	334
0.39	6.0 x 11.0 x 7.2	0.64									394		
0.47					85... (750)	86... (750)	21... (2000)	22... (2000)	25... (1000)	26... (1000)	28... (1000)	29... (1000)	474

Notes

- ⁽¹⁾ Weight for short lead product only
- SPQ = Standard Packing Quantity



DC Film Capacitors
MKT Radial Potted Type

Vishay BCcomponents

U_{Rdc} = 100 V; U_{Rac} = 40 V (compact size)

C (µF)	DIMENSIONS w x h x l (mm)	MASS (g) ⁽¹⁾	CATALOG NUMBER BFC2 370 XYYYY AND PACKAGING								C-VALUE ..YYY
			AMMOPACK		LOOSE IN BOX				REEL		
			H = 18.5 mm; P ₀ = 12.7 mm		Short leads		Long leads				
			C-tol. = ± 10 %	C-tol. = ± 5 %	C-tol. = ± 10 %	C-tol. = ± 5 %	C-tol. = ± 10 %	C-tol. = ± 5 %	C-tol. = ± 10 %	C-tol. = ± 5 %	
		XX (SPQ)	XX (SPQ)	XX (SPQ)	XX (SPQ)	XX (SPQ)	XX (SPQ)	XX (SPQ)	XX (SPQ)		
Pitch = 5.08 mm ± 0.30 mm; d _t = 0.50 mm ± 0.05 mm											
0.12	3.5 x 8.0 x 7.2	0.30	CB... (1500)	CC... (1500)	CE... (2000)	CF... (2000)	CH... (1000)	CI... (1000)	CL... (1500)	CM... (1500)	124
0.15											154
0.18											184
0.22											224
0.27											274
0.33											334
0.39	4.5 x 9.0 x 7.2	0.42	CB... (1000)	CC... (1000)	CE... (2000)	CF... (2000)	CH... (1000)	CI... (1000)	CL... (1000)	CM... (1000)	394
0.47											474
0.56	6.0 x 11.0 x 7.2	0.64	CB... (750)	CC... (750)	CE... (2000)	CF... (2000)	CH... (1000)	CI... (1000)	CL... (1000)	CM... (1000)	564

Notes

- ⁽¹⁾ Weight for short lead product only
- SPQ = Standard Packing Quantity

U_{Rdc} = 250 V; U_{Rac} = 160 V (standard size)

C (µF)	DIMENSIONS w x h x l (mm)	MASS (g) ⁽¹⁾	CATALOG NUMBER BFC2 370 XYYYY AND PACKAGING								C-VALUE ..YYY										
			AMMOPACK		LOOSE IN BOX				REEL												
			H = 18.5 mm; P ₀ = 12.7 mm		Short leads		Long leads														
			C-tol. = ± 10 %	C-tol. = ± 5 %	C-tol. = ± 10 %	C-tol. = ± 5 %	C-tol. = ± 10 %	C-tol. = ± 5 %	C-tol. = ± 10 %	C-tol. = ± 5 %											
		XX (SPQ)	XX (SPQ)	XX (SPQ)	XX (SPQ)	XX (SPQ)	XX (SPQ)	XX (SPQ)	XX (SPQ)												
Pitch = 5.08 mm ± 0.30 mm; d _t = 0.50 mm ± 0.05 mm																					
0.001	2.5 x 6.5 x 7.2	0.18	35... (2000)	36... (2000)	41... (2000)	42... (2000)	45... (1000)	46... (1000)	48... (2000)	49... (2000)	102										
0.0012											122										
0.0015											152										
0.0018											182										
0.0022											222										
0.0027											272										
0.0033											332										
0.0039											392										
0.0047											472										
0.0056											562										
0.0068											682										
0.0082											822										
0.010											103										
0.012											123										
0.015											153										
0.018											183										
0.022											3.5 x 8.0 x 7.2	0.30	35... (1500)	36... (1500)	41... (2000)	42... (2000)	45... (1000)	46... (1000)	48... (1500)	49... (1500)	223
0.027																					273
0.033	333																				
0.039	4.5 x 9.0 x 7.2	0.42	35... (1000)	36... (1000)	41... (2000)	42... (2000)	45... (1000)	46... (1000)	48... (1000)	49... (1000)	393										
0.047											473										
0.056											563										
0.068	6.0 x 11.0 x 7.2	0.64	35... (750)	36... (750)	41... (2000)	42... (2000)	45... (1000)	46... (1000)	48... (1000)	49... (1000)	683										
0.082											823										
0.10											104										

Notes

- ⁽¹⁾ Weight for short lead product only
- SPQ = Standard Packing Quantity

U_{Rdc} = 250 V; U_{Rac} = 63 V (compact size)

C (μF)	DIMENSIONS w x h x l (mm)	MASS (g) ⁽¹⁾	CATALOG NUMBER BFC2 370 XYYYY AND PACKAGING								C-VALUE ..YYY
			AMMOPACK		LOOSE IN BOX				REEL		
			H = 18.5 mm; P ₀ = 12.7 mm		Short leads		Long leads				
			C-tol. = ± 10 %	C-tol. = ± 5 %	C-tol. = ± 10 %	C-tol. = ± 5 %	C-tol. = ± 10 %	C-tol. = ± 5 %	C-tol. = ± 10 %	C-tol. = ± 5 %	
				XX (SPQ)	XX (SPQ)	XX (SPQ)	XX (SPQ)	XX (SPQ)	XX (SPQ)		
Pitch = 5.08 mm ± 0.30 mm; d _t = 0.50 mm ± 0.05 mm											
0.022	2.5 x 6.5 x 7.2	0.18	EB...	EC...	EE...	EF...	EH...	EI...	EL...	EM...	223
0.027			(2000)	(2000)	(2000)	(2000)	(1000)	(1000)	(2000)	(2000)	273
0.033	3.5 x 8.0 x 7.2	0.30	EB...	EC...	EE...	EF...	EH...	EI...	EL...	EM...	333
0.039			(1500)	(1500)	(2000)	(2000)	(1000)	(1000)	(1500)	(1500)	393
0.047			(1500)	(1500)	(2000)	(2000)	(1000)	(1000)	(1500)	(1500)	473
0.056			(1500)	(1500)	(2000)	(2000)	(1000)	(1000)	(1500)	(1500)	563
0.068			(1500)	(1500)	(2000)	(2000)	(1000)	(1000)	(1500)	(1500)	683
0.082	4.5 x 9.0 x 7.2	0.42	EB...	EC...	EE...	EF...	EH...	EI...	EL...	EM...	823
0.10			(1000)	(1000)	(2000)	(2000)	(1000)	(1000)	(1000)	(1000)	104
0.12	6.0 x 11.0 x 7.2	0.64	EB...	EC...	EE...	EF...	EH...	EI...	EL...	EM...	124
0.15			(750)	(750)	(2000)	(2000)	(1000)	(1000)	(1000)	(1000)	154
0.18			(750)	(750)	(2000)	(2000)	(1000)	(1000)	(1000)	(1000)	184
0.22			(750)	(750)	(2000)	(2000)	(1000)	(1000)	(1000)	(1000)	224

Notes

(1) Weight for short lead product only

• SPQ = Standard Packing Quantity

U_{Rdc} = 400 V; U_{Rac} = 220 V (standard size)

C (μF)	DIMENSIONS w x h x l (mm)	MASS (g) ⁽¹⁾	CATALOG NUMBER BFC2 370 XYYYY AND PACKAGING								C-VALUE ..YYY		
			AMMOPACK		LOOSE IN BOX				REEL				
			H = 18.5 mm; P ₀ = 12.7 mm		Short leads		Long leads						
			C-tol. = ± 10 %	C-tol. = ± 5 %	C-tol. = ± 10 %	C-tol. = ± 5 %	C-tol. = ± 10 %	C-tol. = ± 5 %	C-tol. = ± 10 %	C-tol. = ± 5 %			
				XX (SPQ)	XX (SPQ)	XX (SPQ)	XX (SPQ)	XX (SPQ)	XX (SPQ)				
Pitch = 5.08 mm ± 0.30 mm; d _t = 0.50 mm ± 0.05 mm													
0.001	2.5 x 6.5 x 7.2	0.18									102		
0.0012												122	
0.0015												152	
0.0018												182	
0.0022												222	
0.0027					65...	66...	51...	52...	55...	56...	58...	59...	272
0.0033					(2000)	(2000)	(2000)	(2000)	(1000)	(1000)	(2000)	(2000)	332
0.0039					(2000)	(2000)	(2000)	(2000)	(1000)	(1000)	(2000)	(2000)	392
0.0047					(2000)	(2000)	(2000)	(2000)	(1000)	(1000)	(2000)	(2000)	472
0.0056					(2000)	(2000)	(2000)	(2000)	(1000)	(1000)	(2000)	(2000)	562
0.0068					(2000)	(2000)	(2000)	(2000)	(1000)	(1000)	(2000)	(2000)	682
0.0082			(2000)	(2000)	(2000)	(2000)	(1000)	(1000)	(2000)	(2000)	822		
0.010	3.5 x 8.0 x 7.2	0.30	65...	66...	51...	52...	55...	56...	58...	59...	103		
0.012			(1500)	(1500)	(2000)	(2000)	(1000)	(1000)	(1500)	(1500)	123		
0.015			(1500)	(1500)	(2000)	(2000)	(1000)	(1000)	(1500)	(1500)	153		
0.018	4.5 x 9.0 x 7.2	0.42	65...	66...	51...	52...	55...	56...	58...	59...	183		
0.022			(1000)	(1000)	(2000)	(2000)	(1000)	(1000)	(1000)	(1000)	223		
0.027			(1000)	(1000)	(2000)	(2000)	(1000)	(1000)	(1000)	(1000)	273		
0.033	6.0 x 11.0 x 7.2	0.64	65...	66...	51...	52...	55...	56...	58...	59...	333		
0.039			(750)	(750)	(2000)	(2000)	(1000)	(1000)	(1000)	(1000)	393		
0.047			(750)	(750)	(2000)	(2000)	(1000)	(1000)	(1000)	(1000)	473		

Notes

(1) Weight for short lead product only

• SPQ = Standard Packing Quantity



DC Film Capacitors
MKT Radial Potted Type

Vishay BCcomponents

$U_{Rdc} = 400\text{ V}$; $U_{Rac} = 160\text{ V}$ (compact size)

C (μF)	DIMENSIONS w x h x l (mm)	MASS (g) ⁽¹⁾	CATALOG NUMBER BFC2 370 XYYYY AND PACKAGING								C-VALUE ..YYY
			AMMOPACK		LOOSE IN BOX				REEL		
			H = 18.5 mm; P ₀ = 12.7 mm		Short leads		Long leads				
			C-tol. = $\pm 10\%$	C-tol. = $\pm 5\%$	C-tol. = $\pm 10\%$	C-tol. = $\pm 5\%$	C-tol. = $\pm 10\%$	C-tol. = $\pm 5\%$	C-tol. = $\pm 10\%$	C-tol. = $\pm 5\%$	
		XX (SPQ)	XX (SPQ)	XX (SPQ)	XX (SPQ)	XX (SPQ)	XX (SPQ)	XX (SPQ)	XX (SPQ)		
Pitch = 5.08 mm \pm 0.30 mm; d _t = 0.50 mm \pm 0.05 mm											
0.01	2.5 x 6.5 x 7.2	0.18	FB...	FC...	FE...	FF...	FH...	FI...	FL...	FM...	103
0.012			(2000)	(2000)	(2000)	(2000)	(1000)	(1000)	(2000)	(2000)	123
0.015											153
0.018											183
0.022	3.5 x 8.0 x 7.2	0.30	FB...	FC...	FE...	FF...	FH...	FI...	FL...	FM...	223
0.027			(1500)	(1500)	(2000)	(2000)	(1000)	(1000)	(1500)	(1500)	273
0.033											333
0.039											393
0.047	4.5 x 9.0 x 7.2	0.42	FB...	FC...	FE...	FF...	FH...	FI...	FL...	FM...	473
0.056			(1000)	(1000)	(2000)	(2000)	(1000)	(1000)	(1000)	(1000)	563
0.068	6.0 x 11.0 x 7.2	0.64	FB...	FC...	FE...	FF...	FH...	FI...	FL...	FM...	683
0.082			(750)	(750)	(2000)	(2000)	(1000)	(1000)	(1000)	(1000)	823
0.10											104

Notes

⁽¹⁾ Weight for short lead product only

• SPQ = Standard Packing Quantity

$U_{Rdc} = 630\text{ V}$; $U_{Rac} = 220\text{ V}$ (compact size)

C (μF)	DIMENSIONS w x h x l (mm)	MASS (g) ⁽¹⁾	CATALOG NUMBER BFC2 370 XYYYY AND PACKAGING								C-VALUE ..YYY		
			AMMOPACK		LOOSE IN BOX				REEL				
			H = 18.5 mm; P ₀ = 12.7 mm		Short leads		Long leads						
			C-tol. = $\pm 10\%$	C-tol. = $\pm 5\%$	C-tol. = $\pm 10\%$	C-tol. = $\pm 5\%$	C-tol. = $\pm 10\%$	C-tol. = $\pm 5\%$	C-tol. = $\pm 10\%$	C-tol. = $\pm 5\%$			
		XX (SPQ)	XX (SPQ)	XX (SPQ)	XX (SPQ)	XX (SPQ)	XX (SPQ)	XX (SPQ)	XX (SPQ)				
Pitch = 5.08 mm \pm 0.30 mm; d _t = 0.50 mm \pm 0.05 mm													
0.00068	3.5 x 8.0 x 7.2	0.35									681		
0.00082												821	
0.001												102	
0.0012												122	
0.0015												152	
0.0018												182	
0.002												202	
0.0022												222	
0.0024					GB...	GC...	GE...	GF...	GH...	GI...	GL...	GM...	242
0.0027					(1500)	(1500)	(2000)	(2000)	(1000)	(1000)	(1500)	(1500)	272
0.0033												332	
0.0039												392	
0.0047												472	
0.0056												562	
0.0068												682	
0.0082												822	
0.01										103			
0.012	4.5 x 9.0 x 7.2	0.45	GB...	GC...	GE...	GF...	GH...	GI...	GL...	GM...	123		
0.015			(1000)	(1000)	(2000)	(2000)	(1000)	(1000)	(1000)	(1000)	153		
0.018	6.0 x 11.0 x 7.2	0.65	GB...	GC...	GE...	GF...	GH...	GI...	GL...	GM...	183		
0.022			(750)	(750)	(2000)	(2000)	(1000)	(1000)	(1000)	(1000)	223		
0.027											273		
0.033											333		

Notes

⁽¹⁾ Weight for short lead product only

• SPQ = Standard Packing Quantity

MOUNTING

Normal Use

The capacitors are designed for mounting on printed-circuit boards. The capacitors packed in bandoliers are designed for mounting in printed-circuit boards by means of automatic insertion machines.

For detailed tape specifications refer to packaging information: www.vishay.com/doc?28139 or end of catalog.

Specific Method of Mounting to Withstand Vibration and Shock

In order to withstand vibration and shock tests, it must be ensured that stand-off pips are in good contact with the printed-circuit board:

- For pitches ≤ 15 mm capacitors shall be mechanically fixed by the leads
- For larger pitches the capacitors shall be mounted in the same way and the body clamped

Space Requirements On Printed-Circuit Board

The maximum length and width of film capacitors is shown in the drawing:

- Eccentricity as in drawing. The maximum eccentricity is smaller than or equal to the lead diameter of the product concerned.
- Product height with seating plane as given by "IEC 60717" as reference: $h_{\max.} \leq h + 0.3$ mm

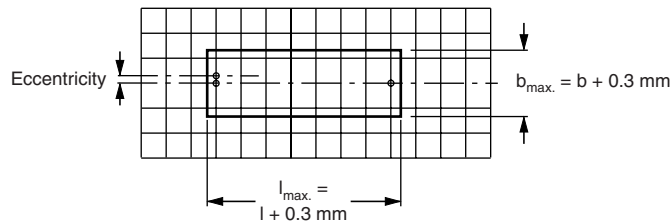

Storage Temperature

- Storage temperature: $T_{\text{stg}} = -25$ °C to $+40$ °C with RH maximum 80 % without condensation

Ratings and Characteristics Reference Conditions

Unless otherwise specified, all electrical values apply to an ambient temperature of 23 °C ± 1 °C, an atmospheric pressure of 86 kPa to 106 kPa and a relative humidity of 50 % ± 2 %.

For reference testing, a conditioning period shall be applied over 96 h ± 4 h by heating the products in a circulating air oven at the rated temperature and a relative humidity not exceeding 20 %.

CHARACTERISTICS

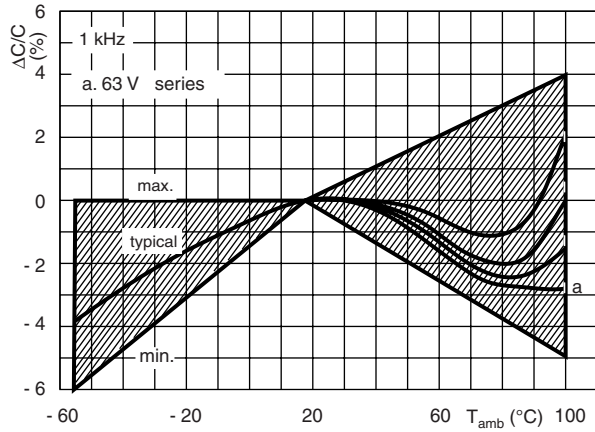
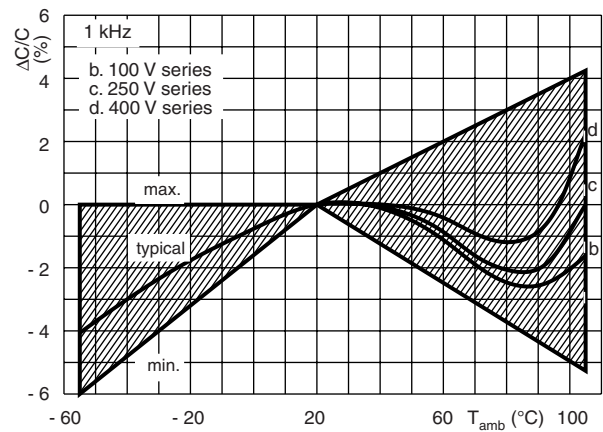
 Capacitance as a function of ambient temperature (typical curve)
for voltage 63 V

 Capacitance as a function of ambient temperature (typical curve)
for voltages > 63 V

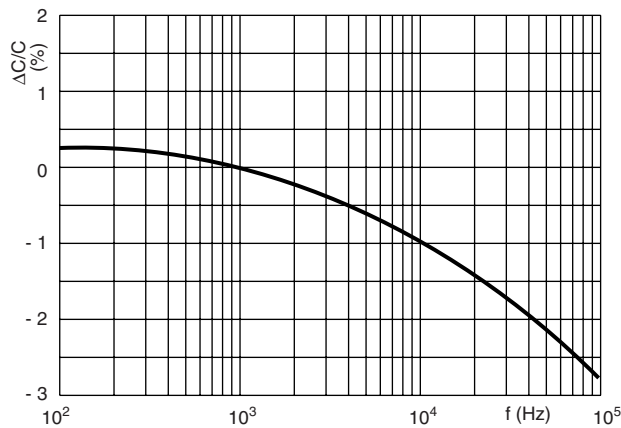
Capacitance as a function of frequency (typical curve)

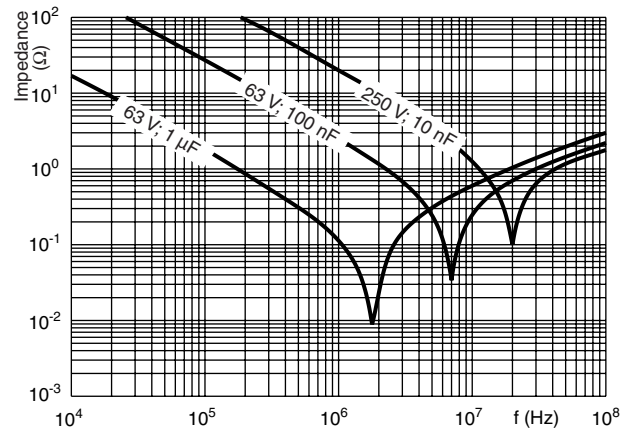

Impedance as a function of frequency



Max. AC voltage as a function of frequency

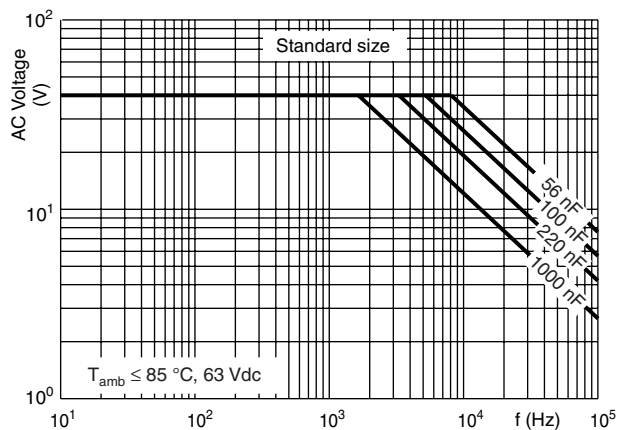

Max. AC voltage as a function of frequency

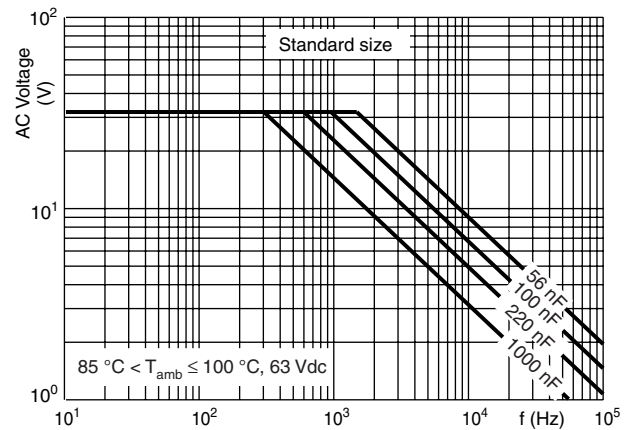

Max. AC voltage as a function of frequency

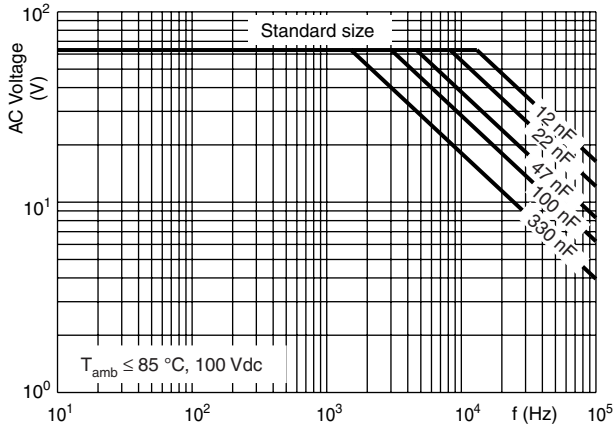

Max. AC voltage as a function of frequency

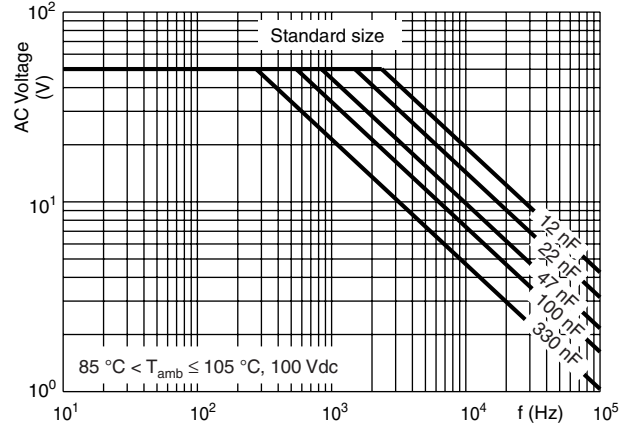

Max. AC voltage as a function of frequency

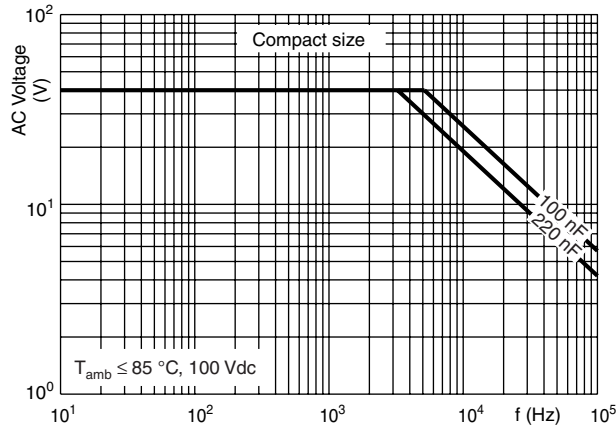

Max. AC voltage as a function of frequency

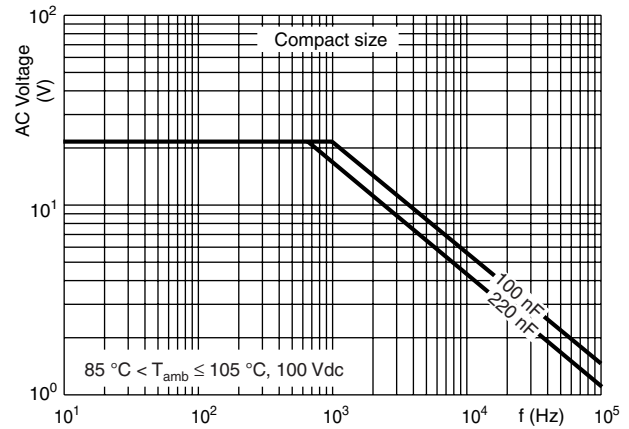

Max. AC voltage as a function of frequency

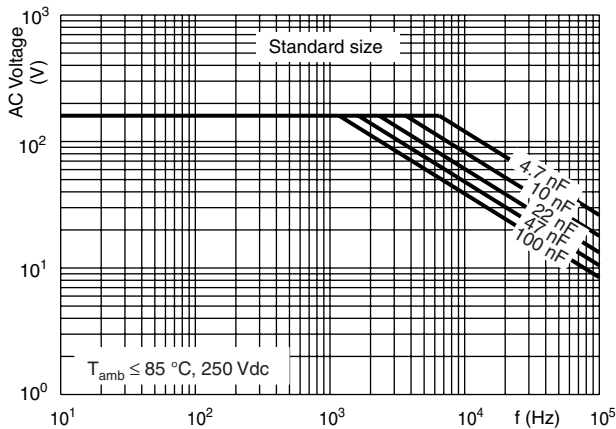

Max. AC voltage as a function of frequency

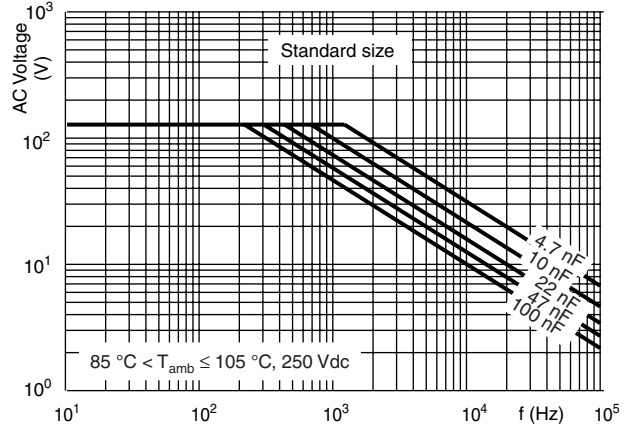

**DC Film Capacitors
MKT Radial Potted Type**
Vishay BCcomponents

Max. AC voltage as a function of frequency

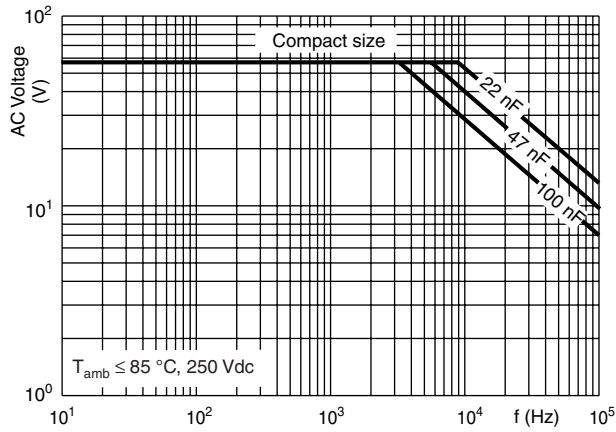

Max. AC voltage as a function of frequency

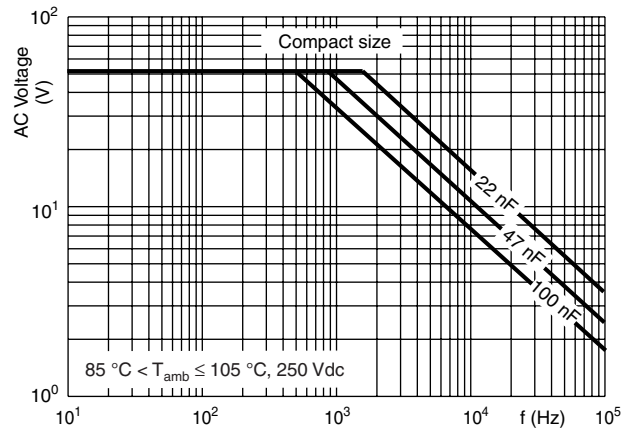

Max. AC voltage as a function of frequency

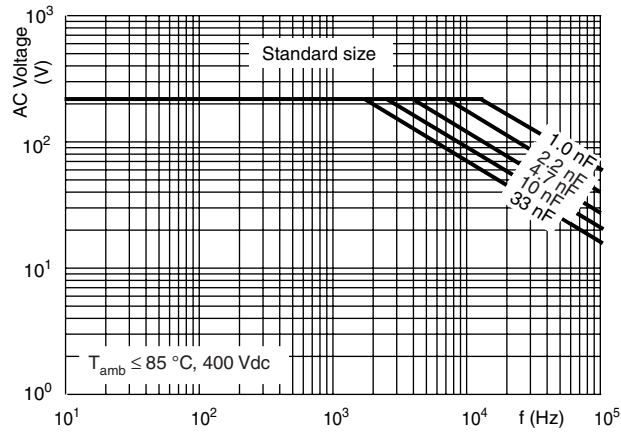

Max. AC voltage as a function of frequency

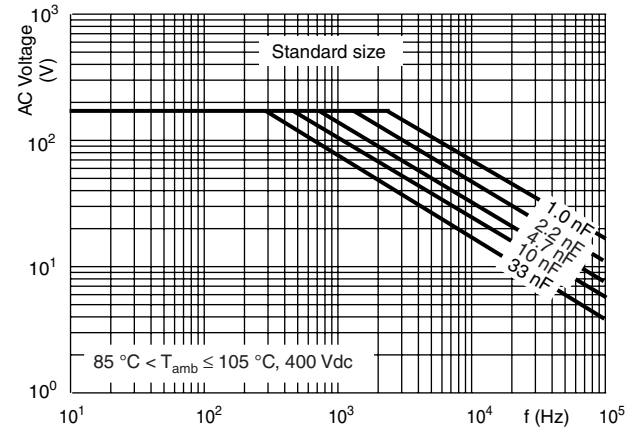

Max. AC voltage as a function of frequency

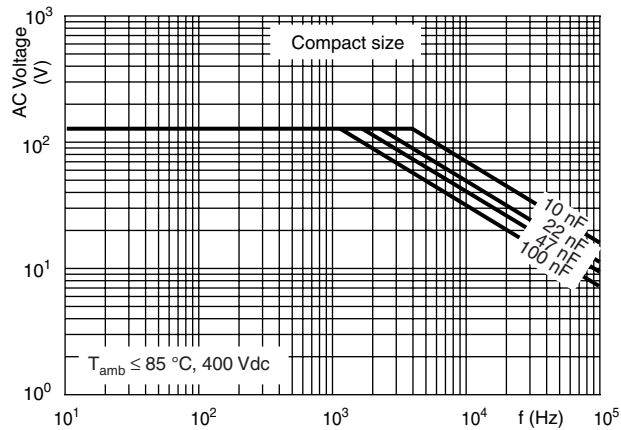

Max. AC voltage as a function of frequency

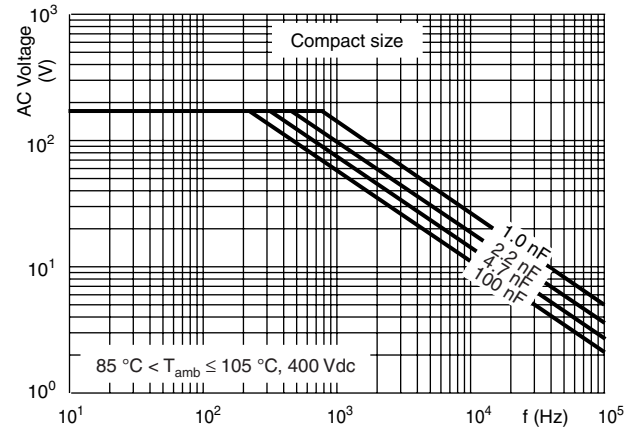

Max. AC voltage as a function of frequency

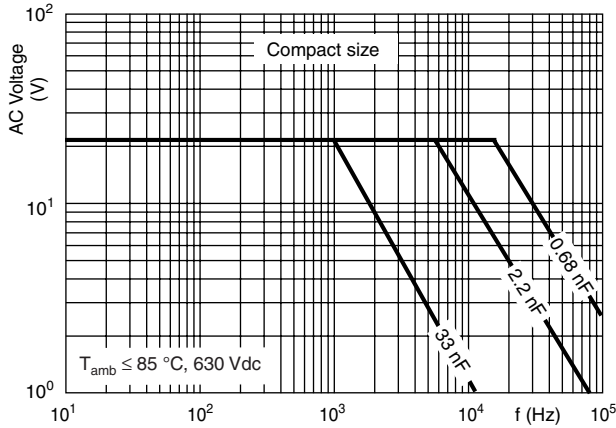

Max. AC voltage as a function of frequency

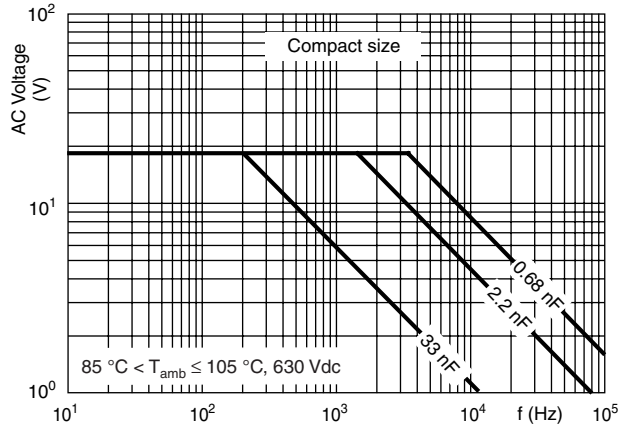

Maximum RMS current (sinewave) as a function of frequency

The maximum RMS current is defined by $I_{ac} = \omega \times C \times U_{ac}$.

U_{ac} is the maximum AC voltage depending on the ambient temperature in the curves "Max. RMS voltage and AC current as a function of frequency".

Tangent of loss angle as a function of frequency
(typical curve)

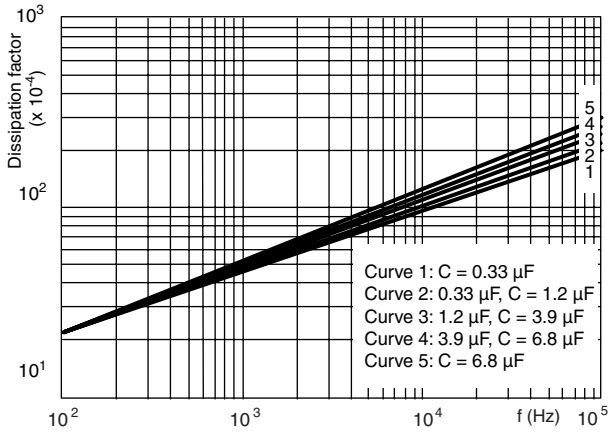

Insulation resistance as a function of the ambient temperature
(typical curve)

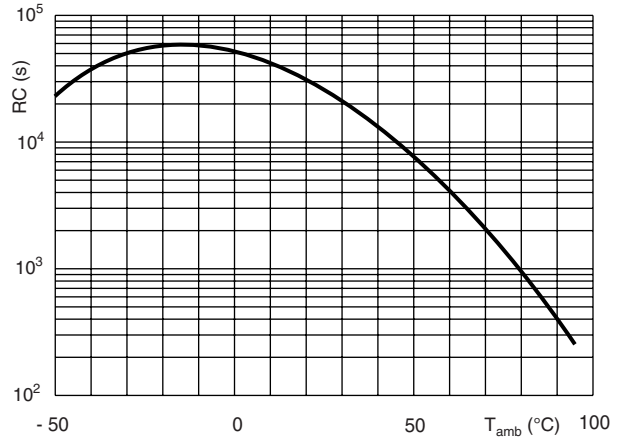

Max. DC and AC voltage as a function of frequency
for voltage 63 V

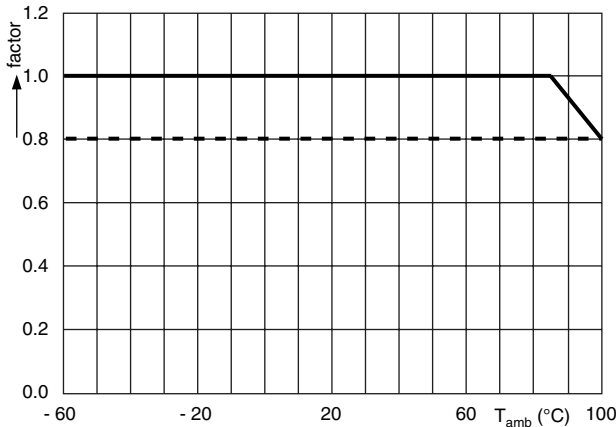

Max. DC and AC voltage as a function of frequency
for voltages > 63 V

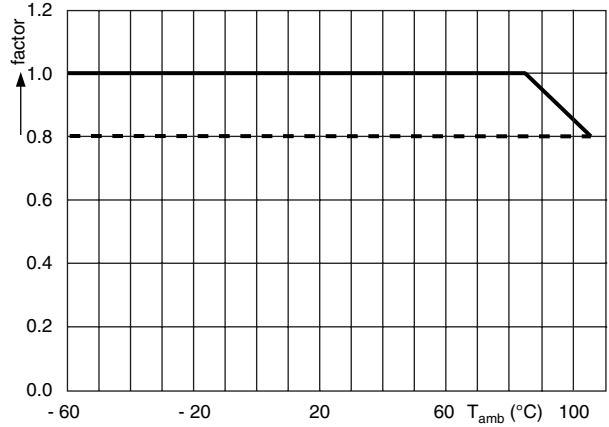

Maximum allowed component temperature rise (ΔT)
as a function of the ambient temperature (T_{amb}) for voltage 63 V

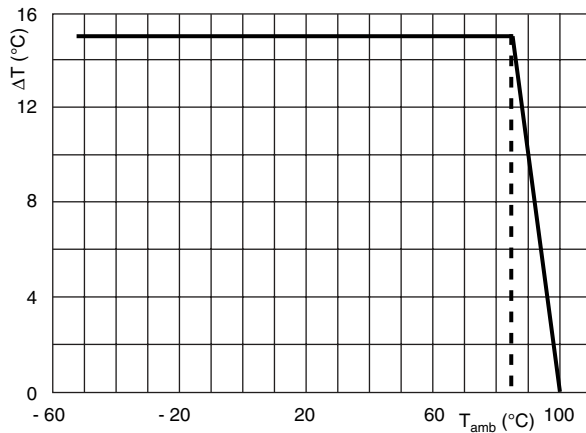

Maximum allowed component temperature rise (ΔT)
as a function of the ambient temperature (T_{amb}) for voltages > 63 V

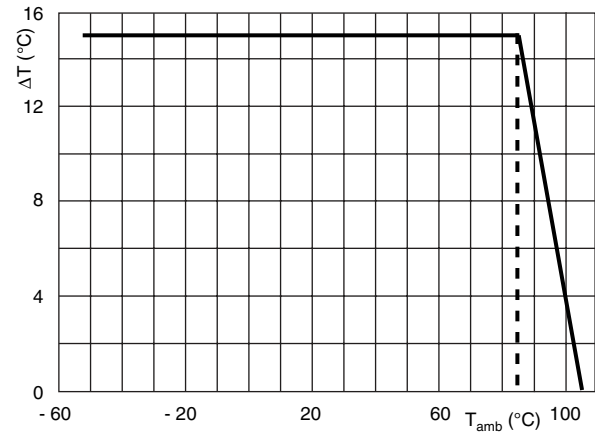

HEAT CONDUCTIVITY (G) AS A FUNCTION OF (ORIGINAL) PITCH AND CAPACITOR BODY THICKNESS IN mW/°C

W _{max.} (mm)	HEAT CONDUCTIVITY (mW/°C)	
	PITCH 5 mm	
2.5	2.5	
3.5	3.0	
4.5	4.0	
6.0	5.5	

POWER DISSIPATION AND MAXIMUM COMPONENT TEMPERATURE RISE

The power dissipation must be limited in order not to exceed the maximum allowed component temperature rise as a function of the free ambient temperature.

The power dissipation can be calculated according type detail specification "HQN-384-01/101: Technical Information Film Capacitors".

The component temperature rise (ΔT) can be measured (see section "Measuring the component temperature" for more details) or calculated by $\Delta T = P/G$:

- ΔT = Component temperature rise (°C)
- P = Power dissipation of the component (mW)
- G = Heat conductivity of the component (mW/°C)

MEASURING THE COMPONENT TEMPERATURE

A thermocouple must be attached to the capacitor body as in:

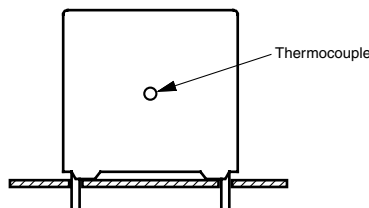

The temperature is measured in unloaded (T_{amb}) and maximum loaded condition (T_C).

The temperature rise is given by $\Delta T = T_C - T_{amb}$.

To avoid radiation or convection, the capacitor should be tested in a wind-free box.

APPLICATION NOTE AND LIMITING CONDITIONS

These capacitors are not suitable for mains applications as across-the-line capacitors without additional protection, as described hereunder. These mains applications are strictly regulated in safety standards and therefore electromagnetic interference suppression capacitors conforming the standards must be used.

To select the capacitor for a certain application, the following conditions must be checked:

1. The peak voltage (U_P) shall not be greater than the rated DC voltage (U_{Rdc})
2. The peak-to-peak voltage (U_{P-P}) shall not be greater than $2\sqrt{2} \times U_{Rac}$ to avoid the ionisation inception level
3. The voltage peak slope (dU/dt) shall not exceed the rated voltage pulse slope in an RC-circuit at rated voltage and without ringing. If the pulse voltage is lower than the rated DC voltage, the rated voltage pulse slope may be multiplied by U_{Rdc} and divided by the applied voltage.
For all other pulses following equation must be fulfilled: $2 \times \int_0^T \left(\frac{dU}{dt}\right)^2 \times dt < U_{Rdc} \times \left(\frac{dU}{dt}\right)_{rated}$
T is the pulse duration.
4. The maximum component surface temperature rise must be lower than the limits (see figure max. allowed component temperature rise).
5. Since in circuits used at voltages over 280 V peak-to-peak the risk for an intrinsically active flammability after a capacitor breakdown (short circuit) increases, it is recommended that the power to the component is limited to 100 times the values mentioned in the table: "Heat conductivity"
6. When using these capacitors as across-the-line capacitor in the input filter for mains applications or as series connected with an impedance to the mains the applicant must guarantee that the following conditions are fulfilled in any case (spikes and surge voltages from the mains included).

Voltage Conditions for 6 Above

ALLOWED VOLTAGES	$T_{amb} \leq 85\text{ °C}$	$85\text{ °C} < T_{amb} \leq 100\text{ °C}$ for 63 V
		$85\text{ °C} < T_{amb} \leq 105\text{ °C}$ for > 63 V
Maximum continuous RMS voltage	U_{Rac}	See "Max. AC voltage as function of temperature CBB952" per characteristics
Maximum temperature RMS-overvoltage (< 24 h)	$1.25 \times U_{Rac}$	U_{Rac}
Maximum peak voltage (V_{O-P}) (< 2 s)	$1.6 \times U_{Rdc}$	$1.3 \times U_{Rdc}$

EXAMPLE

C = 330 nF - 63 V used for the voltage signal shown in next drawing.

$U_{P-P} = 40\text{ V}$; $U_P = 35\text{ V}$; $T_1 = 100\text{ }\mu\text{s}$; $T_2 = 200\text{ }\mu\text{s}$

The ambient temperature is 35 °C

Checking conditions:

1. The peak voltage $U_P = 35\text{ V}$ is lower than 63 Vdc
2. The peak-to-peak voltage 40 V is lower than $2\sqrt{2} \times 40\text{ Vac} = 113\text{ V}$
3. The voltage pulse slope (dU/dt) = $40\text{ V}/100\text{ }\mu\text{s} = 0.4\text{ V}/\mu\text{s}$
This is lower than $60\text{ V}/\mu\text{s}$ (see specific reference data for each version)
4. The dissipated power is 16.2 mW as calculated with fourier terms
The temperature rise for $W_{max.} = 3.5\text{ mm}$ and pitch = 5 mm will be $16.2\text{ mW}/3.0\text{ mW}/\text{°C} = 5.4\text{ °C}$
This is lower than 15 °C temperature rise at 35 °C , according figure max. allowed component temperature rise
5. Not applicable
6. Not applicable

Voltage Signal

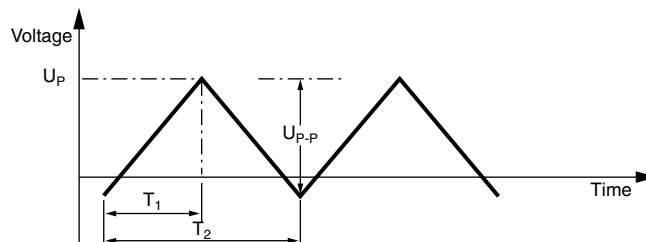



INSPECTION REQUIREMENTS

General Notes:

Sub-clause numbers of tests and performance requirements refer to the “Sectional Specification, Publication IEC 60384-2 and Specific Reference Data”.

Group C Inspection Requirements

SUB-CLAUSE NUMBER AND TEST	CONDITIONS	PERFORMANCE REQUIREMENTS
SUB-GROUP C1A PART OF SAMPLE OF SUB-GROUP C1		
4.1 Dimensions (detail)		As specified in chapters “MKT 370 General Data” of this specification
4.3.1 Initial measurements	Capacitance Tangent of loss angle: For C ≤ 470 nF at 100 kHz or for C > 470 nF at 10 kHz	
4.3 Robustness of terminations	Tensile and bending	No visible damage
4.4 Resistance to soldering heat	Method: 1A Solder bath: 280 °C ± 5 °C Duration: 10 s	
4.14 Component solvent resistance	Isopropylalcohol at room temperature Method: 2 Immersion time: 5 min ± 0.5 min Recovery time: Min. 1 h, max. 2 h	
4.4.2 Final measurements	Visual examination Capacitance Tangent of loss angle	No visible damage Legible marking $ \Delta C/C \leq 2\%$ of the value measured initially Increase of $\tan \delta$ ≤ 0.005 for: C ≤ 100 nF or ≤ 0.010 for: 100 nF < C ≤ 220 nF or ≤ 0.015 for: 220 nF < C ≤ 470 nF and ≤ 0.003 for: C > 470 nF Compared to values measured in 4.3.1
SUB-GROUP C1B OTHER PART OF SAMPLE OF SUB-GROUP C1		
4.6.1 Initial measurements	Capacitance Tangent of loss angle: For C ≤ 470 nF at 100 kHz or for C > 470 nF at 10 kHz	
4.6 Rapid change of temperature	θA = - 55 °C θB = + 100 °C for rated voltage 63 V + 105 °C for rated voltage > 63 V 5 cycles Duration t = 30 min	
4.7 Vibration	Visual examination Mounting: See section “Mounting” of this specification Procedure B4 Frequency range: 10 Hz to 55 Hz Amplitude: 0.75 mm or Acceleration 98 m/s ² (whichever is less severe) Total duration 6 h	No visible damage
4.7.2 Final inspection	Visual examination	No visible damage



SUB-CLAUSE NUMBER AND TEST	CONDITIONS	PERFORMANCE REQUIREMENTS
<p>4.9 Shock</p> <p>4.9.3 Final measurements</p>	<p>Mounting: See section "Mounting" of this specification Pulse shape: Half sine Acceleration: 490 m/s² Duration of pulse: 11 ms</p> <p>Visual examination</p> <p>Capacitance</p> <p>Tangent of loss angle</p> <p>Insulation resistance</p>	<p>No visible damage</p> <p>$\Delta C/C \leq 3\%$ of the value measured in 4.6.1</p> <p>Increase of $\tan \delta$ ≤ 0.010 for: $C \leq 220$ nF or ≤ 0.015 for: 220 nF < $C \leq 470$ nF and ≤ 0.003 for: $C > 470$ nF</p> <p>Compared to values measured in 4.6.1</p> <p>As specified in section "Specific Reference Data 370" of this specification</p>
<p>SUB-GROUP C1 COMBINED SAMPLE OF SPECIMENS OF SUB-GROUPS C1A AND C1B</p>		
<p>4.10 Climatic sequence</p> <p>4.10.2 Dry heat</p> <p>4.10.3 Damp heat cyclic Test Db, first cycle</p> <p>4.10.4 Cold</p> <p>4.10.6 Damp heat cyclic Test Db, remaining cycles</p> <p>4.10.6.2 Final measurements</p>	<p>Temperature: + 100 °C for rated voltage 63 V + 105 °C for rated voltage > 63 V Duration: 16 h</p> <p>Temperature: - 55 °C Duration: 2 h</p> <p>Voltage proof = U_{Rdc} for 1 min within 15 min after removal from testchamber</p> <p>Visual examination</p> <p>Capacitance</p> <p>Tangent of loss angle</p> <p>Insulation resistance</p>	<p>No breakdown of flash-over</p> <p>No visible damage Legible marking</p> <p>$\Delta C/C \leq 5\%$ of the value measured in 4.4.2 or 4.9.3</p> <p>Increase of $\tan \delta$ ≤ 0.010 for: $C \leq 220$ nF or ≤ 0.015 for: 220 nF < $C \leq 470$ nF and ≤ 0.005 for: $C > 470$ nF</p> <p>Compared to values measured in 4.3.1 or 4.6.1</p> <p>$\geq 50\%$ of values specified in section "Specific Reference Data 370" of this specification</p>
<p>SUB-GROUP C2</p>		
<p>4.11 Damp heat steady state</p> <p>4.11.1 Initial measurements</p>	<p>56 days, 40 °C, 90 % to 95 % RH</p> <p>Capacitance Tangent of loss angle at 1 kHz</p>	



DC Film Capacitors
MKT Radial Potted Type

Vishay BCcomponents

SUB-CLAUSE NUMBER AND TEST	CONDITIONS	PERFORMANCE REQUIREMENTS
4.11.3 Final measurements	Voltage proof = U_{Rdc} for 1 min within 15 min after removal from testchamber Visual examination Capacitance Tangent of loss angle Insulation resistance	No breakdown of flash-over No visible damage Legible marking $ \Delta C/C \leq 5\%$ of the value measured in 4.11.1. Increase of $\tan \delta \leq 0.005$ Compared to values measured in 4.11.1 $\geq 50\%$ of values specified in section "Specific Reference Data 370" of this specification
SUB-GROUP C3		
4.12 Endurance 4.12.1 Initial measurements 4.12.5 Final measurements	Duration: 2000 h $1.25 \times U_{Rdc}$ at 85 °C $0.8 \times 1.25 U_{Rdc}$ at + 100 °C for rated voltage 63 V $0.8 \times 1.25 U_{Rdc}$ at + 105 °C for rated voltage > 63 V Capacitance Tangent of loss angle: For $C \leq 470$ nF at 100 kHz or for $C > 470$ nF at 10 kHz Visual examination Capacitance Tangent of loss angle Insulation resistance	No visible damage Legible marking $ \Delta C/C \leq 5\%$ compared to values measured in 4.12.1 Increase of $\tan \delta$ ≤ 0.005 for at 85 °C ≤ 0.010 for at 100 °C for: $C \leq 220$ nF or ≤ 0.015 for: 220 nF < $C \leq 470$ nF and ≤ 0.003 for: $C > 470$ nF Compared to values measured in 4.12.1 $\geq 50\%$ of values specified in section "Specific Reference Data 370" of this specification
SUB-GROUP C4		
4.13 Charge and discharge 4.13.1 Initial measurements 4.13.3 Final measurements	10 000 cycles Charged to U_{Rdc} Discharge resistance: $R = \frac{U_R}{C \times 2.5 \times (dU/dt)_R}$ Capacitance Tangent of loss angle: For $C \leq 470$ nF at 100 kHz or for $C > 470$ nF at 10 kHz Capacitance Tangent of loss angle Insulation resistance	$ \Delta C/C \leq 3\%$ compared to values measured in 4.13.1 Increase of $\tan \delta$ ≤ 0.005 for: $C \leq 100$ nF or ≤ 0.010 for: 100 nF < $C \leq 220$ nF or ≤ 0.015 for: 220 nF < $C \leq 470$ nF and ≤ 0.003 for: $C > 470$ nF Compared to values measured in 4.13.1 $\geq 50\%$ of values specified in section "Specific Reference Data 370" of this specification



Disclaimer

All product specifications and data are subject to change without notice.

Vishay Intertechnology, Inc., its affiliates, agents, and employees, and all persons acting on its or their behalf (collectively, "Vishay"), disclaim any and all liability for any errors, inaccuracies or incompleteness contained herein or in any other disclosure relating to any product.

Vishay disclaims any and all liability arising out of the use or application of any product described herein or of any information provided herein to the maximum extent permitted by law. The product specifications do not expand or otherwise modify Vishay's terms and conditions of purchase, including but not limited to the warranty expressed therein, which apply to these products.

No license, express or implied, by estoppel or otherwise, to any intellectual property rights is granted by this document or by any conduct of Vishay.

The products shown herein are not designed for use in medical, life-saving, or life-sustaining applications unless otherwise expressly indicated. Customers using or selling Vishay products not expressly indicated for use in such applications do so entirely at their own risk and agree to fully indemnify Vishay for any damages arising or resulting from such use or sale. Please contact authorized Vishay personnel to obtain written terms and conditions regarding products designed for such applications.

Product names and markings noted herein may be trademarks of their respective owners.