

## Features

- Planar Die Construction
- 350mW Power Dissipation
- Zener Voltages from 2.4V - 39V
- Ideally Suited for Automated Assembly Processes
- **Lead, Halogen and Antimony Free, RoHS Compliant "Green" Device (Notes 3 and 4)**
- **Qualified to AEC-Q101 Standards for High Reliability**

## Mechanical Data

- Case: SOT-23
- Case Material: Molded Plastic. UL Flammability Classification Rating 94V-0
- Moisture Sensitivity: Level 1 per J-STD-020
- Terminals: Matte Tin Finish annealed over Alloy 42 leadframe (Lead Free Plating). Solderable per MIL-STD-202, Method 208
- Polarity: See Diagram
- Marking Information: See Page 3
- Ordering Information: See Page 3
- Weight: 0.008 grams (approximate)



Top View

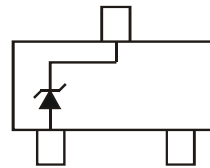

Device Schematic

## Maximum Ratings @ $T_A = 25^\circ\text{C}$ unless otherwise specified

Characteristic	Symbol	Value	Unit
Forward Voltage @ $I_F = 10\text{mA}$	$V_F$	0.9	V

## Thermal Characteristics

Characteristic	Symbol	Value	Unit
Power Dissipation (Note 1)	$P_D$	300	mW
Power Dissipation (Note 2)	$P_D$	350	mW
Thermal Resistance, Junction to Ambient Air (Note 1)	$R_{\theta JA}$	417	$^\circ\text{C/W}$
Thermal Resistance, Junction to Ambient Air (Note 2)	$R_{\theta JA}$	357	$^\circ\text{C/W}$
Operating and Storage Temperature Range	$T_J, T_{STG}$	-65 to +150	$^\circ\text{C}$

- Notes:
1. Device mounted on FR-4 PC board with recommended pad layout, which can be found on our website at <http://www.diodes.com/datasheets/ap02001.pdf>.
  2. Valid provided the terminals are kept at ambient temperature.
  3. No purposefully added lead. Halogen and Antimony Free.
  4. Product manufactured with Data Code V9 (week 33, 2008) and newer are built with Green Molding Compound. Product manufactured prior to Date Code V9 are built with Non-Green Molding Compound and may contain Halogens or  $\text{Sb}_2\text{O}_3$  Fire Retardants.

**Electrical Characteristics** @T<sub>A</sub> = 25°C unless otherwise specified

Type Number	Marking Code	Zener Voltage Range (Note 5)				Maximum Zener Impedance (Note 6)			Maximum Reverse Current (Note 5)		Typical Temperature Coefficient @ I <sub>ZT</sub> mV/°C	
		V <sub>Z</sub> @ I <sub>ZT</sub>			I <sub>ZT</sub> (mA)	Z <sub>KT</sub> @ I <sub>ZT</sub> (Ω)	Z <sub>ZK</sub> @ I <sub>ZK</sub>		I <sub>R</sub> (μA)	V <sub>R</sub> (V)	Min	Max
		Nom (V)	Min (V)	Max (V)			(Ω)	(mA)				
BZX84C2V4	KZB	2.4	2.2	2.6	5.0	100	600	1.0	50	1.0	-3.5	0
BZX84C2V7	KZC	2.7	2.5	2.9	5.0	100	600	1.0	20	1.0	-3.5	0
BZX84C3V0	KZD	3.0	2.8	3.2	5.0	95	600	1.0	10	1.0	-3.5	0
BZX84C3V3	KZE	3.3	3.1	3.5	5.0	95	600	1.0	5.0	1.0	-3.5	0
BZX84C3V6	KZF	3.6	3.4	3.8	5.0	90	600	1.0	5.0	1.0	-3.5	0
BZX84C3V9	KZG	3.9	3.7	4.1	5.0	90	600	1.0	3.0	1.0	-3.5	0
BZX84C4V3	KZH	4.3	4.0	4.6	5.0	90	600	1.0	3.0	1.0	-3.5	0
BZX84C4V7	KZ1	4.7	4.4	5.0	5.0	80	500	1.0	3.0	2.0	-3.5	0.2
BZX84C5V1	KZ2	5.1	4.8	5.4	5.0	60	480	1.0	2.0	2.0	-2.7	1.2
BZX84C5V6	KZ3	5.6	5.2	6.0	5.0	40	400	1.0	1.0	2.0	-2.0	2.5
BZX84C6V2	KZ4	6.2	5.8	6.6	5.0	10	150	1.0	3.0	4.0	0.4	3.7
BZX84C6V8	KZ5	6.8	6.4	7.2	5.0	15	80	1.0	2.0	4.0	1.2	4.5
BZX84C7V5	KZ6	7.5	7.0	7.9	5.0	15	80	1.0	1.0	5.0	2.5	5.3
BZX84C8V2	KZ7	8.2	7.7	8.7	5.0	15	80	1.0	0.7	5.0	3.2	6.2
BZX84C9V1	KZ8	9.1	8.5	9.6	5.0	15	100	1.0	0.5	6.0	3.8	7.0
BZX84C10	KZ9	10	9.4	10.6	5.0	20	150	1.0	0.2	7.0	4.5	8.0
BZX84C11	KY1	11	10.4	11.6	5.0	20	150	1.0	0.1	8.0	5.4	9.0
BZX84C12	KY2	12	11.4	12.7	5.0	25	150	1.0	0.1	8.0	6.0	10.0
BZX84C13	KY3	13	12.4	14.1	5.0	30	170	1.0	0.1	8.0	7.0	11.0
BZX84C15	KY4	15	13.8	15.6	5.0	30	200	1.0	0.1	10.5	9.2	13.0
BZX84C16	KY5	16	15.3	17.1	5.0	40	200	1.0	0.1	11.2	10.4	14.0
BZX84C18	KY6	18	16.8	19.1	5.0	45	225	1.0	0.1	12.6	12.4	16.0
BZX84C20	KY7	20	18.8	21.2	5.0	55	225	1.0	0.1	14.0	14.4	18.0
BZX84C22	KY8	22	20.8	23.3	5.0	55	250	1.0	0.1	15.4	16.4	20.0
BZX84C24	KY9	24	22.8	25.6	5.0	70	250	1.0	0.1	16.8	18.4	22.0
BZX84C27	KYA	27	25.1	28.9	2.0	80	300	0.5	0.1	18.9	21.4	25.3
BZX84C30	KYB	30	28.0	32.0	2.0	80	300	0.5	0.1	21.0	24.4	29.4
BZX84C33	KYC	33	31.0	35.0	2.0	80	325	0.5	0.1	23.1	27.4	33.4
BZX84C36	KYD	36	34.0	38.0	2.0	90	350	0.5	0.1	25.2	30.4	37.4
BZX84C39	KYE	39	37.0	41.0	2.0	130	350	0.5	0.1	27.3	33.4	41.2

Notes: 5. Short duration pulse test used to minimize self-heating effect.  
6. f = 1KHz.

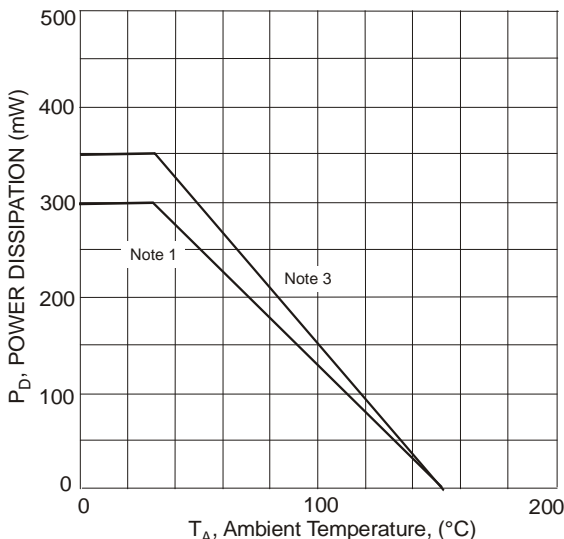

Fig. 1 Power Derating Curve

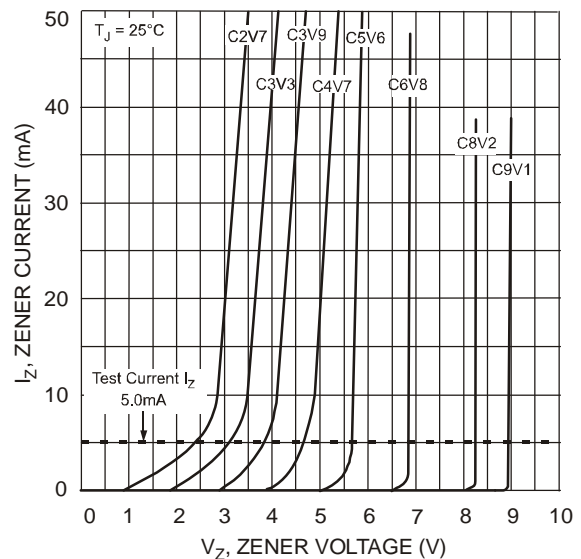

Fig. 2 Typical Zener Breakdown Characteristics

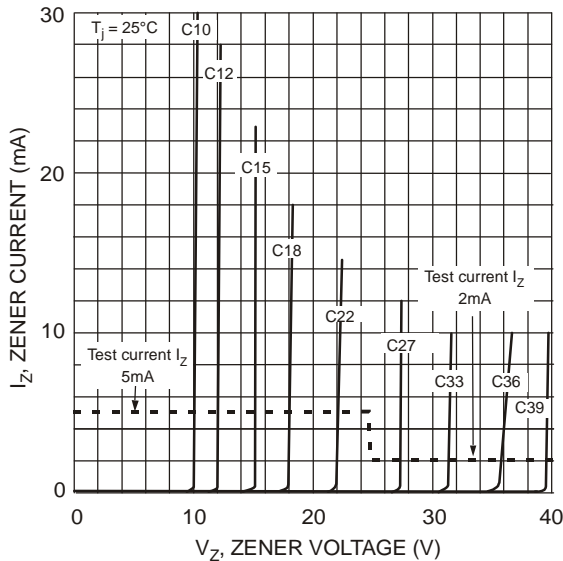

Fig. 3 Typical Zener Breakdown Characteristics

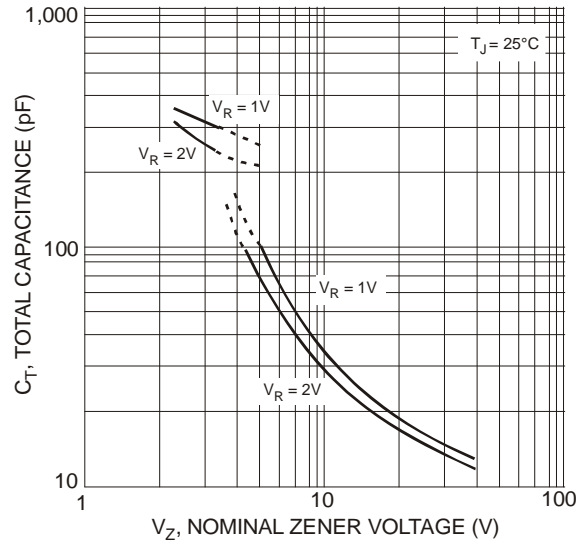

Fig. 4 Typical Total Capacitance vs. Nominal Zener Voltage

**Ordering Information** (Note 7)

Part Number	Case	Packaging
(Type Number)-7-F (Note 8)	SOT-23	3,000/Tape & Reel
(Type Number)-13-F (Note 9)	SOT-23	10,000/Tape & Reel

- Notes:
- For packaging details, go to our website at <http://www.diodes.com/datasheets/ap02007.pdf>.
  - Add "-7-F" to the appropriate type number in Electrical Characteristics Table on Page 2. Example: 6.2V Zener = BZX84C6V2-7-F.
  - Add "-13-F" to the appropriate type number in Electrical Characteristics Table on Page 2. Example: 2.7V Zener = BZX84C2V7-13-F. Please note: Not all voltages are available in 13" reel size. Please contact the Diodes Inc. Sales Department for assistance in ordering 13" reel size devices.

**Marking Information**

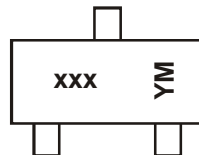

xxx = Product Type Marking Code  
(See Electrical Characteristics Table)  
YM = Date Code Marking  
Y = Year (ex: N = 2002)  
M = Month (ex: 9 = September)

Date Code Key

Year	1998	1999	2000	2001	2002	2003	2004	2005	2006	2007	2008	2009	2010	2011	2012	2013	2014	2015
Code	J	K	L	M	N	P	R	S	T	U	V	W	X	Y	Z	A	B	C
Month	Jan	Feb	Mar	Apr	May	Jun	Jul	Aug	Sep	Oct	Nov	Dec						
Code	1	2	3	4	5	6	7	8	9	O	N	D						

**Package Outline Dimensions**

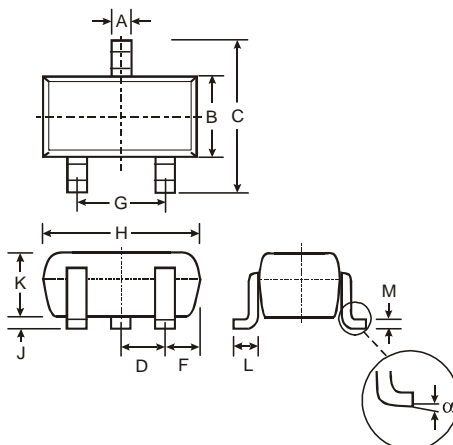

SOT-23		
Dim	Min	Max
A	0.37	0.51
B	1.20	1.40
C	2.30	2.50
D	0.89	1.03
F	0.45	0.60
G	1.78	2.05
H	2.80	3.00
J	0.013	0.10
K	0.903	1.10
L	0.45	0.61
M	0.085	0.180
α	0°	8°
All Dimensions in mm		

## Suggested Pad Layout

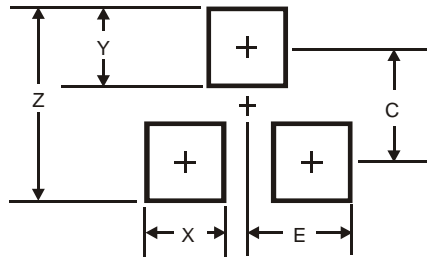

Dimensions	Value (in mm)
Z	2.9
X	0.8
Y	0.9
C	2.0
E	1.35

### IMPORTANT NOTICE

DIODES INCORPORATED MAKES NO WARRANTY OF ANY KIND, EXPRESS OR IMPLIED, WITH REGARDS TO THIS DOCUMENT, INCLUDING, BUT NOT LIMITED TO, THE IMPLIED WARRANTIES OF MERCHANTABILITY AND FITNESS FOR A PARTICULAR PURPOSE (AND THEIR EQUIVALENTS UNDER THE LAWS OF ANY JURISDICTION).

Diodes Incorporated and its subsidiaries reserve the right to make modifications, enhancements, improvements, corrections or other changes without further notice to this document and any product described herein. Diodes Incorporated does not assume any liability arising out of the application or use of this document or any product described herein; neither does Diodes Incorporated convey any license under its patent or trademark rights, nor the rights of others. Any Customer or user of this document or products described herein in such applications shall assume all risks of such use and will agree to hold Diodes Incorporated and all the companies whose products are represented on Diodes Incorporated website, harmless against all damages.

Diodes Incorporated does not warrant or accept any liability whatsoever in respect of any products purchased through unauthorized sales channel. Should Customers purchase or use Diodes Incorporated products for any unintended or unauthorized application, Customers shall indemnify and hold Diodes Incorporated and its representatives harmless against all claims, damages, expenses, and attorney fees arising out of, directly or indirectly, any claim of personal injury or death associated with such unintended or unauthorized application.

Products described herein may be covered by one or more United States, international or foreign patents pending. Product names and markings noted herein may also be covered by one or more United States, international or foreign trademarks.

### LIFE SUPPORT

Diodes Incorporated products are specifically not authorized for use as critical components in life support devices or systems without the express written approval of the Chief Executive Officer of Diodes Incorporated. As used herein:

A. Life support devices or systems are devices or systems which:

1. are intended to implant into the body, or
2. support or sustain life and whose failure to perform when properly used in accordance with instructions for use provided in the labeling can be reasonably expected to result in significant injury to the user.

B. A critical component is any component in a life support device or system whose failure to perform can be reasonably expected to cause the failure of the life support device or to affect its safety or effectiveness.

Customers represent that they have all necessary expertise in the safety and regulatory ramifications of their life support devices or systems, and acknowledge and agree that they are solely responsible for all legal, regulatory and safety-related requirements concerning their products and any use of Diodes Incorporated products in such safety-critical, life support devices or systems, notwithstanding any devices- or systems-related information or support that may be provided by Diodes Incorporated. Further, Customers must fully indemnify Diodes Incorporated and its representatives against any damages arising out of the use of Diodes Incorporated products in such safety-critical, life support devices or systems.

Copyright © 2009, Diodes Incorporated

[www.diodes.com](http://www.diodes.com)