

GRM21BR61C106KE15#

" # " indicates a package specification code.



< List of part numbers with package codes >
 GRM21BR61C106KE15L , GRM21BR61C106KE15K , GRM21BR61C106KE15C , GRM21BR61C106KE15B

Shape

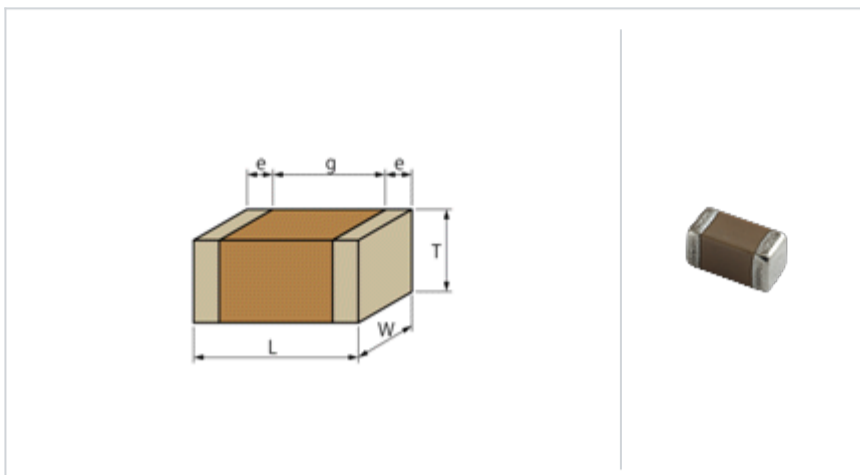

L size	2.0 ± 0.1mm
W size	1.25 ± 0.1mm
T size	1.25 ± 0.1mm
External terminal width e	0.2 to 0.7mm
Distance between external terminals g (Min.)	0.7mm
Size code in mm(inch)	2012 (0805)

References

Packaging	Specifications	Minimum quantity
L	Embossed tape (180mm)	3000
K	Embossed tape (330mm)	10000
C	Bulk case	5000
B	Packing in bulk	1000

Mass (typ.)	
1 piece	17mg
Reel (180mm)	102g

Specifications

Capacitance	10µF ± 10%
Rated voltage	16Vdc
Temperature characteristics (complied standard)	X5R(EIA)
Capacitance change rate	± 15%
Temperature range of temperature characteristics	-55 to 85
Operating temperature range	-55 to 85

⚠ Attention

- 1.This datasheet is downloaded from the website of Murata Manufacturing Co., Ltd. Therefore, it ' s specifications are subject to change or our products in it may be discontinued without advance notice. Please check with our sales representatives or product engineers before ordering.
- 2.This datasheet has only typical specifications because there is no space for detailed specifications. Therefore, please review our product specifications or consult the approval sheet for product specifications before ordering.

▪ Frequency characteristics (ESR, Impedance)

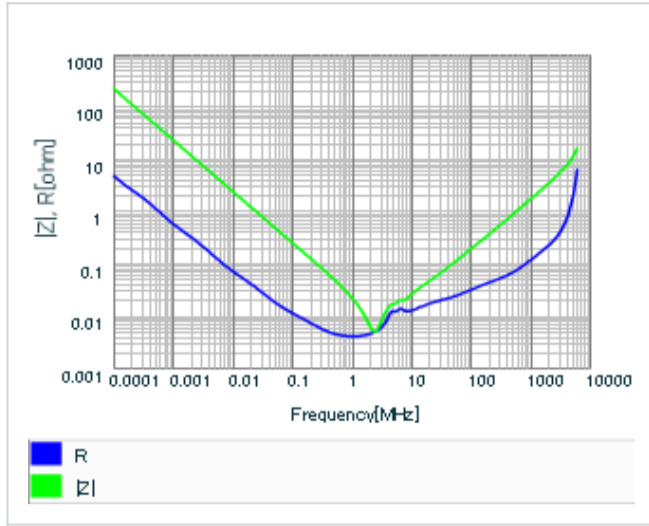

▪ S parameter (Smith chart S11)

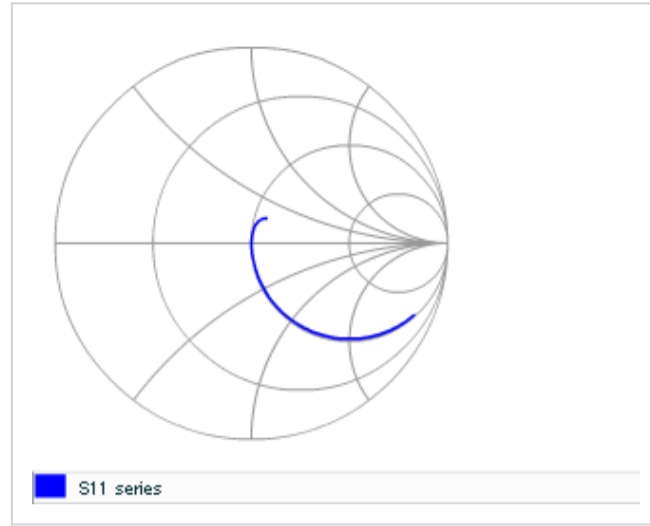

▪ DC bias characteristics

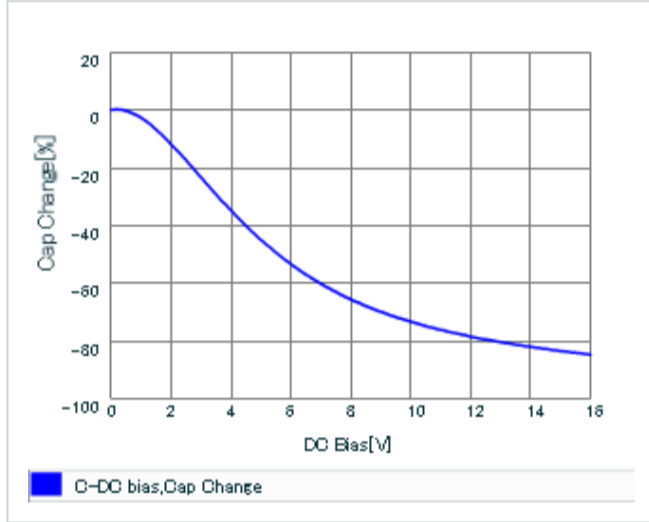

▪ AC voltage characteristics

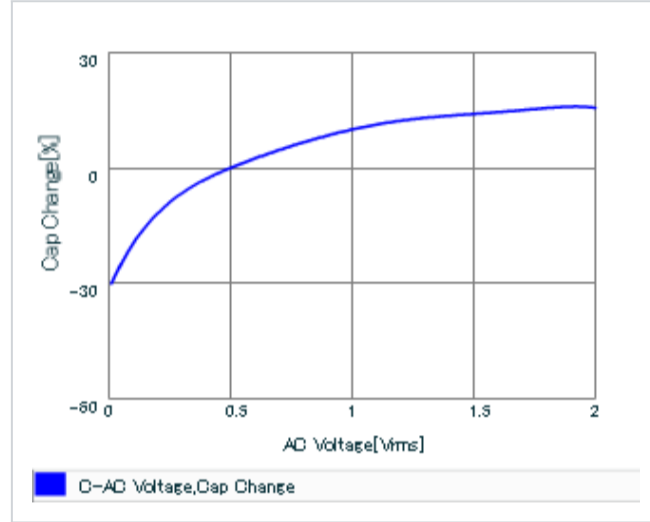

▪ Capacitance - temperature characteristics

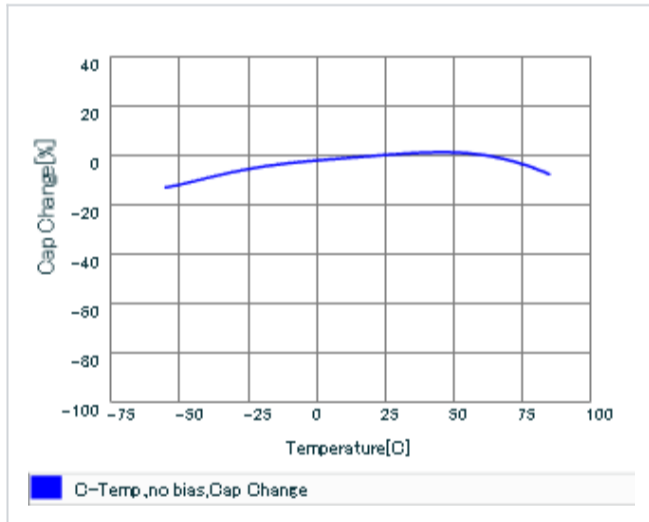

▪ Calorific property by ripple current

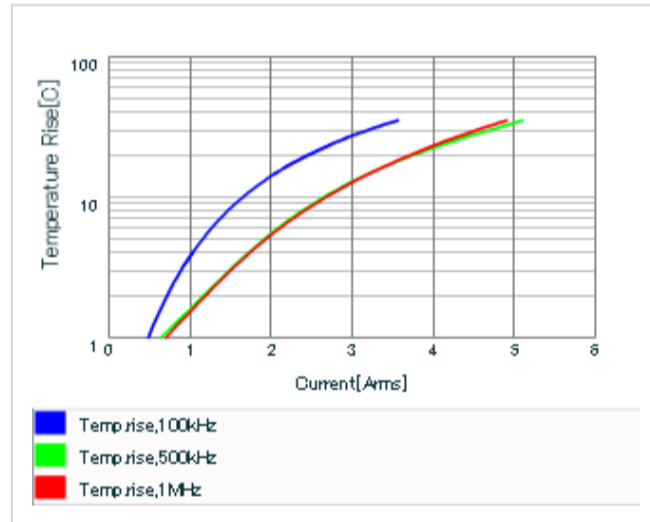

This PDF data has only typical specifications because there is no space for detailed specifications. Therefore, please review our product specifications or consult the approval sheet for product specifications before ordering.