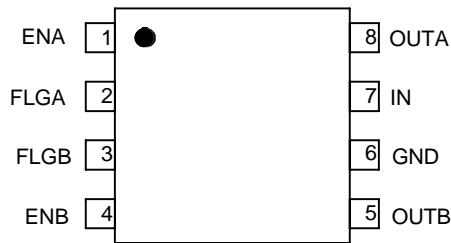
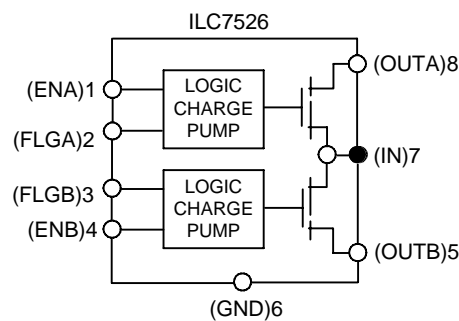



Figure 2: Pin Configuration



Pin Number	Pin Name	Pin Description
1	ENA	Enable A (input): Logic-compatible enable input. (7526 active-high, 7536 active-low). Do not float.
2	FLGA	Fault Flag A (Output): Active-low, open-drain output. Indicates overcurrent, UVLO, or thermal shutdown.
3	FLGB	Fault Flag B (Output): Active-low, open-drain output. Indicates overcurrent, UVLO, or thermal shutdown.
4	ENB	Enable B (Input): Logic-compatible enable input. (7526 active-high, 7536 active-low). Do not float.
5	OUTB	Switch Output B: Output MOSFET source. Typically connect to switched side of load.
6	GND	Ground: Supply return.
7	IN	Supply Input: Output MOSFET drain. Also supplies IC's internal circuitry. Connect to positive supply.
8	OUTA	Switch Output A: Output MOSFET source. Typically connect to switched side of load.



## Absolute Maximum Ratings (Note 1, notes on next page)

Parameter	Symbol	Ratings	Units
Input Supply Voltage	$V_{IN}$	+6	V
Fault Flag Voltage	$V_{FLG}$	+6	V
Fault Flag Current	$I_{FLG}$	50	mA
Output Voltage	$V_{OUT}$	+6	V
Output Current	$I_{OUT}$	Internally Limited	mA
ENABLE Input Voltage	$V_{EN}$	-0.3 to +12	V
Storage Temperature	$T_{STG}$	-40 to +125	°C
Operating Ambient Temperature	$T_A$	-40 to +85	°C
Package Thermal Resistance SOIC 8-Pin DIP	$\theta_{JA}$	120 130	°C/W °C/W
Lead Temperature (soldering 5 sec)	$\theta_{JA}$	260	°C

## Electrical Characteristics ILC7526IK

Test circuit shown in Fig. 2. **BOLDFACE** type indicates limits that apply over the full operating temperature range (**Note 2**).

Parameter	Symbol	Conditions	Min	Typ	Max	Units
Supply Current	$I_{SS}$	Switch off, OUT = Open All switches on, OUT = Open		0.75 110		$\mu$ A $\mu$ A
ENABLE Input Threshold	$V_{ENTH}$	Low to high transition High to low transition (Note 3)	0.8	2.1 1.9	2.4	V V
ENABLE Input Current	$I_{EN}$	$V_{EN} = 0V$ to 5.8V	-1	+0.01	1	$\mu$ A
ENABLE Input Capacitance	$C_{EN}$			1		pF
Switch resistance	$R_{DSON}$	$V_{IN} = 5V$ , $I_{OUT} = 500mA$ each switch $V_{IN} = 3.3V$ , $I_{OUT} = 500mA$ each switch		100 140	140 180	m $\Omega$ m $\Omega$
Output Turn-on Delay	$T_{ON}$	$R_L = 10\Omega$ each output		0.5		ms
Output Turn-on Rise Time	$T_{OR}$	$R_L = 10\Omega$ each output		1		ms
Output Turn-off Delay	$T_{OFD}$	$R_L = 10\Omega$ each output		1	20	$\mu$ s
Output Turn-off Fall Time	$T_{OFF}$	$R_L = 10\Omega$ each output		1	20	$\mu$ s
Output Leakage Current	$I_{OL}$	Output disabled, each output			10	$\mu$ A
Continuous Load Current	$I_{OUT}$	Each output	0.5			A
Short Circuit Current Limit	$I_{SCL}$	ENABLE into load, $V_{OUT} = 4.0V$	0.5	0.75	1.25	A
Current Limit Threshold	$I_{LTH}$	Ramped load to enabled output $V_{OUT} < 4.0V$ , Note 2		1.6	2.2	A
Over Temperature Shutdown Threshold	$O_{TTH}$	$T_J$ (Junction temperature) increasing $T_J$ (Junction temperature) decreasing		135 125		°C °C
Error Flag Output Resistance	$R_{FLG}$	$V_{IN} = 5V$ , $I_L = 10mA$ $V_{IN} = 3.3V$ , $I_L = 10mA$		10 15	25 40	$\Omega$ $\Omega$
Error Flag Off Current	$I_{FLG}$	$V_{FLG} = 5V$		0.01	1	$\mu$ A
Under Voltage Lockout Threshold	UVLO	$V_{IN} =$ increasing $V_{IN} =$ decreasing		2.5 2.3		V

**Note 1.** Stresses above those listed under ABSOLUTE MAXIMUM RATINGS may cause permanent device failure. Functionality at or above these limits is not implied. Exposure to absolute maximum ratings for extended periods may affect device reliability. Operating ranges define those limits between which the functionality of the device is guaranteed.

**Note 2.** Specified min/max limits are production tested or guaranteed

through correlation based on statistical control methods. Measurements are taken at constant junction temperature as close to ambient as possible using low duty pulse testing.

**Note 3.** Off is  $\leq 0.8\text{V}$  and On is  $\geq 2.4\text{V}$  for the ILC7526. Off is  $\geq 2.4\text{V}$  for the ILC7536. The enable input has approximately 200mV of hysteresis.

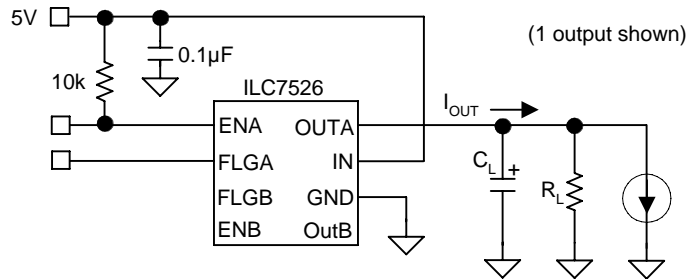

## Functional Description

The ILC7526 and ILC7536 are dual high-side switches with active-high and active-low enable inputs, respectively. Fault conditions turn-off or inhibit turn-on of one or more of the output transistors, depending upon the type of fault, and also activate the open-drain error flag transistors which sink current to ground.

### Input and Output

IN (input) is the power supply connection to the logic circuitry and the drains of both of the output MOSFET's. OUTx (output) is the source of each MOSFET. In a typical circuit, current flows through the switch from IN to OUT toward the load. If  $V_{OUT}$  is greater than  $V_{IN}$  when a switch is enabled, current will flow from OUT to IN since the MOSFET is bidirectional when on.

The output MOSFET and driver circuitry are also designed to allow the MOSFET source to be externally forced to a higher voltage than the drain ( $V_{OUT} > V_{IN}$ ) when the output is off. In this situation, the ILC7526 avoids undesirable current flow from OUT to IN. If  $V_{IN} < 2.5\text{V}$ , UVLO disables both switches.

### Thermal Shutdown

Thermal shutdown shuts off the affected output MOSFET's and signals all fault flags if the die temperature exceeds  $135^{\circ}\text{C}$ .  $10^{\circ}\text{C}$  of hysteresis prevents the switch from turning on until the die temperature drops to  $125^{\circ}\text{C}$ . Overtemperature detection functions only when at least one switch is enabled.

### Current Limit Induced Thermal Shutdown

Internal circuitry increases the output MOSFET on-resistance until the series combination of the MOSFET on-resistance and the load impedance limit current to typically 850mA. The increase in power dissipation, in most cases, will cause the ILC7526 to go into thermal shutdown, disabling affected channels. When this is undesirable, thermal shutdown can be avoided by externally responding to the fault and disabling the current limited channel before the shutdown temperature is reached. The delay between the flag indication of a current limit fault and thermal shutdown will vary with ambient temperature, board layout, and load impedance, but is typically several hundred milliseconds. The USB controller must therefore recognize a fault and disable the appropriate channel within this time. If the fault is not removed or the switch is not disabled within this time, the device will enter into a thermal oscillation of about 2Hz. This does not cause any damage to the device.

### Undervoltage Lockout

UVLO (undervoltage lockout) prevents the output MOSFET from turning on until  $V_{IN}$  exceeds approximately 2.5V. In the undervoltage state, the FLAG will be low. After the switch turns on, if the voltage drops below approximately 2.3V, UVLO shuts off the output MOSFET and signals fault flag. Undervoltage detection functions only when at least one switch is enabled.

### Current Sensing and Limiting

The current-limit threshold is preset internally. The preset level prevents damage to the output MOSFET and external load but allows a minimum current of 0.5A through the output MOSFET of each channel. The current-limit circuit senses a portion of the output FET switch current. The reaction to an overcurrent condition varies with three scenarios:

### Switch Enabled into Short Circuit

If a switch is powered on or enabled into a heavy load or short circuit, the switch immediately goes into a constant-current mode, reducing the output voltage. The fault flag goes low until the load is reduced.

### Short Circuit Applied to Output

When a heavy load is applied, a large transient current may flow until the current limit circuitry will respond. Once this occurs, the device limits current to less than the short-circuit current limit specification.

### Current-Limit Response

The ILC7526 current-limit profile exhibits a small foldback effect of approximately 500mA. Once this current-limit threshold is exceeded the device enters constant-current mode. This constant current is specified as the short circuit current limit in the “Electrical Characteristics” table. It is important to note that the device will deliver load current up to the current-limit threshold which is typically 1.6A.

### Fault Flag

FLG is an N-channel, open-drain MOSFET output. The fault-flag is active (low) for one or more of the following conditions: undervoltage (while  $2V < V_{IN} < 2.7$ ), current limit, or thermal shutdown. The flag output MOSFET is capable of sinking a 10mA load to typically 100mV above ground. Multiple FLG pins may be wired “NORed” to a common pull-up resistor.

## APPLICATIONS INFORMATION

### Supply Filtering

A 0.1 $\mu$ F to 1 $\mu$ F bypass capacitor from IN to GND, located at the device, is strongly recommended to control supply transients. Without a bypass capacitor, an output short may cause sufficient ringing on the input (from supply lead inductance) to damage internal control circuitry. Input or output transients must not exceed the absolute maximum output supply voltage ( $V_{IN\ MAX} = 6V$ ) even for a short duration.

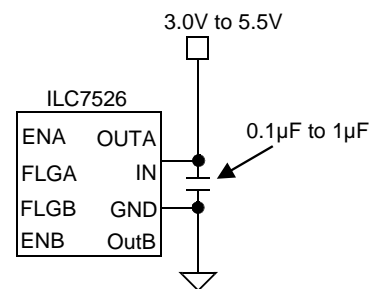

### Enable Input

EN must be driven logic high or logic low for a clearly defined input. Floating the input may cause unpredictable operation. EN should not be allowed to go negative with respect to GND.

### Soft-Start

The ILC7526 presents a high impedance when off, and slowly becomes a low impedance as it turns on. This reduces inrush current and related voltage drop that results from charging a capacitive load, satisfying the USB voltage drop requirements for bus-powered applications.

Package Dimensions

All dimensions in inches

8-Pin SOIC

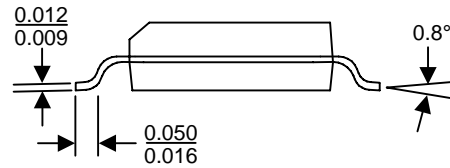
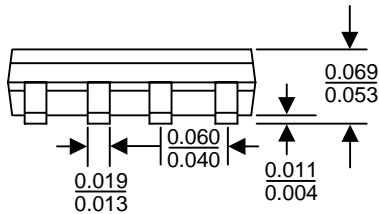
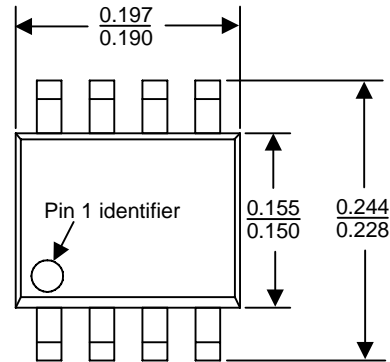

8-Pin DIP

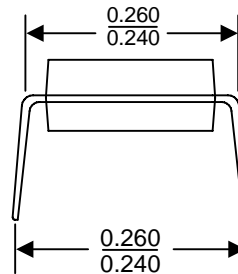
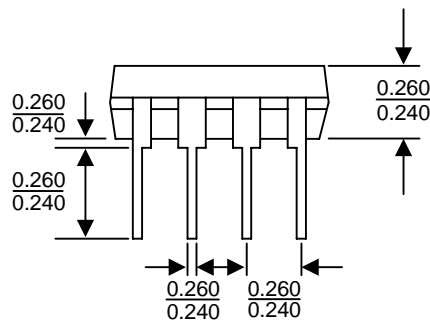
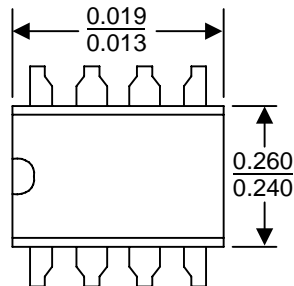

Devices sold by Impala Linear Corporation are covered by the warranty and patent indemnification provisions appearing in its Terms of Sale only. Impala Linear Corporation makes no warranty, express, statutory, implied, or by description regarding the information set forth herein or regarding the freedom of the described devices from patent infringement. Impala Linear Corporation makes no warranty of merchantability or fitness for any purpose. Impala Linear Corporation reserves the right to discontinue production and change specifications and prices at any time and without notice.

This product is intended for use in normal commercial applications. Applications requiring an extended temperature range, unusual environmental requirements, or high reliability applications, such as military and aerospace, are specifically not recommended without additional processing by Impala Linear Corporation.

Impala Linear Corporation assumes no responsibility for the use of any circuitry other than circuitry embodied in an Impala Linear Corporation product. No other circuits, patents, licenses are implied.

Life Support Policy

Impala Linear Corporation's products are not authorized for use as critical components in life support devices or systems.

1. Life support devices or systems are devices or systems which, (a) are intended for surgical implant into the body, or (b) support or sustain life, and whose failure to perform, when properly used in accordance with instructions for use provided in the labeling, can be reasonably expected to result in a significant injury to the user.
2. A critical component is any component of a life support device or system whose failure to perform can be reasonably expected to cause the failure of the life support device or system, or to affect its safety or effectiveness.