

SMD Inductors(Coils) For High Frequency(Multilayer)

Conformity to RoHS Directive

MLG Series MLG0603S

FEATURES

- Inductance values are supported from 0.3 to 100nH.
- Advanced monolithic structure is formed using a multilayering and sintering process with ceramic and conductive materials for high-frequency.
- The products contain no lead and also support lead-free soldering.
- It is a product conforming to RoHS directive.

APPLICATIONS

For high-frequency applications including mobile phones, high frequency modules (PA, VCO, FEM etc.), Bluetooth, W-LAN, UWB and tuners.

SHAPES AND DIMENSIONS

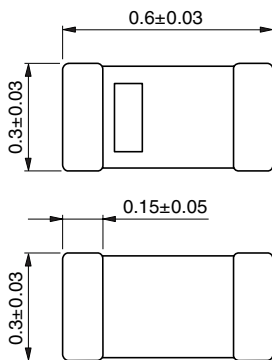

Weight: 0.2mg

RECOMMENDED PC BOARD PATTERN

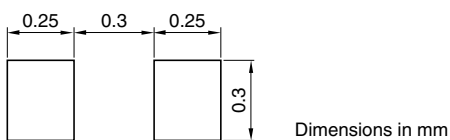

RECOMMENDED SOLDERING CONDITION REFLOW SOLDERING

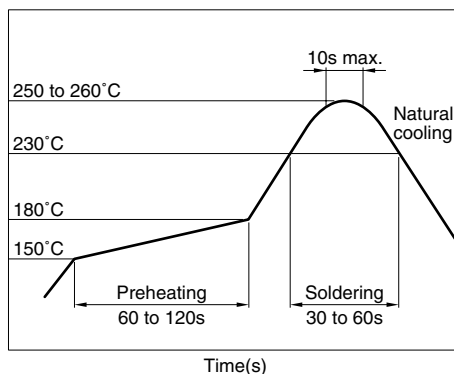

- Conformity to RoHS Directive: This means that, in conformity with EU Directive 2002/95/EC, lead, cadmium, mercury, hexavalent chromium, and specific bromine-based flame retardants, PBB and PBDE, have not been used, except for exempted applications.

- Please contact our Sales office when your application are considered the following:
The device's failure or malfunction may directly endanger human life (e.g. application for automobile/aircraft/medical/nuclear power devices, etc.)

- All specifications are subject to change without notice.

PRODUCT IDENTIFICATION

MLG	0603	S	2N2	S	T
(1)	(2)	(3)	(4)	(5)	(6)

(1) Series name

(2) Dimensions

0603	0.6×0.3mm (L×W)
------	-----------------

(3) Material code

(4) Inductance value

2N2	2.2nH
12N	12nH
R10	100nH

(5) Inductance tolerance

B	±0.1nH
C	±0.2nH
S	±0.3nH
H	±3%
J	±5%

(6) Packaging style

T	Taping (reel)
---	---------------

SPECIFICATIONS

Operating temperature range	-55 to +125°C
Storage temperature range	-55 to +125°C

PACKAGING STYLE AND QUANTITIES

Packaging style	Quantity
Taping	15000 pieces/reel

HANDLING AND PRECAUTIONS

- Before soldering, be sure to preheat components.
The preheating temperature should be set so that the temperature difference between the solder temperature and product temperature does not exceed 150°C.
- After mounting components onto the printed circuit board, do not apply stress through board bending or mishandling.
- When hand soldering, apply the soldering iron to the printed circuit board only. Temperature of the iron tip should not exceed 350°C. Soldering time should not exceed 3 seconds.

ELECTRICAL CHARACTERISTICS

Inductance (nH)	Inductance tolerance	Q min.	Test frequency L, Q (MHz)	Self-resonant frequency (GHz)		DC resistance (Ω)		Rated current (mA)max.	Part No.*
				min.	typ.	max.	typ.		
0.3	$\pm 0.1, \pm 0.2$ nH	—	100	10.0	20 up	0.1	0.02	600	MLG0603S0N3□T
0.4	$\pm 0.1, \pm 0.2$ nH	—	100	10.0	20 up	0.1	0.02	600	MLG0603S0N4□T
0.5	$\pm 0.1, \pm 0.2$ nH	—	100	10.0	20 up	0.1	0.02	600	MLG0603S0N5□T
0.6	$\pm 0.1, \pm 0.2$ nH	—	100	10.0	20 up	0.1	0.02	600	MLG0603S0N6□T
0.7	$\pm 0.1, \pm 0.2$ nH	—	100	10.0	16.3	0.1	0.02	600	MLG0603S0N7□T
0.8	$\pm 0.1, \pm 0.2$ nH	—	100	10.0	16.1	0.1	0.03	600	MLG0603S0N8□T
0.9	$\pm 0.1, \pm 0.2$ nH	—	100	10.0	13.8	0.1	0.03	600	MLG0603S0N9□T
1.0	$\pm 0.1, \pm 0.2, 0.3$ nH	4	100	10.0	14.4	0.1	0.04	600	MLG0603S1N0□T
1.1	$\pm 0.1, \pm 0.2, 0.3$ nH	4	100	10.0	13.6	0.15	0.04	550	MLG0603S1N1□T
1.2	$\pm 0.1, \pm 0.2, 0.3$ nH	4	100	10.0	12.3	0.15	0.06	550	MLG0603S1N2□T
1.3	$\pm 0.1, \pm 0.2, 0.3$ nH	4	100	9.0	11.4	0.15	0.07	550	MLG0603S1N3□T
1.5	$\pm 0.1, \pm 0.2, 0.3$ nH	4	100	9.0	10.4	0.15	0.07	550	MLG0603S1N5□T
1.6	$\pm 0.1, \pm 0.2, 0.3$ nH	4	100	9.0	11.5	0.2	0.09	500	MLG0603S1N6□T
1.8	$\pm 0.1, \pm 0.2, 0.3$ nH	4	100	8.5	10.0	0.2	0.12	500	MLG0603S1N8□T
2.0	$\pm 0.1, \pm 0.2, 0.3$ nH	4	100	8.2	9.8	0.25	0.14	400	MLG0603S2N0□T
2.2	$\pm 0.1, \pm 0.2, 0.3$ nH	4	100	8.0	8.9	0.25	0.14	400	MLG0603S2N2□T
2.4	$\pm 0.1, \pm 0.2, 0.3$ nH	4	100	8.0	9.2	0.25	0.15	300	MLG0603S2N4□T
2.7	$\pm 0.1, \pm 0.2, 0.3$ nH	4	100	6.5	8.1	0.25	0.15	300	MLG0603S2N7□T
3.0	$\pm 0.1, \pm 0.2, 0.3$ nH	4	100	6.2	7.8	0.3	0.20	300	MLG0603S3N0□T
3.3	$\pm 0.1, \pm 0.2, 0.3$ nH	4	100	5.8	7.0	0.35	0.23	300	MLG0603S3N3□T
3.6	$\pm 0.1, \pm 0.2, 0.3$ nH	4	100	5.5	6.9	0.35	0.22	300	MLG0603S3N6□T
3.9	$\pm 0.1, \pm 0.2, 0.3$ nH	5	100	5.0	6.6	0.4	0.27	300	MLG0603S3N9□T
4.3	$\pm 3\%, \pm 0.3$ nH	5	100	5.0	6.4	0.4	0.27	300	MLG0603S4N3□T
4.7	$\pm 3\%, \pm 0.3$ nH	5	100	4.5	5.4	0.45	0.28	300	MLG0603S4N7□T
5.1	$\pm 3\%, \pm 0.3$ nH	5	100	4.5	5.5	0.45	0.23	250	MLG0603S5N1□T
5.6	$\pm 3\%, \pm 0.3$ nH	5	100	4.2	5.3	0.5	0.31	250	MLG0603S5N6□T
6.2	$\pm 3\%, \pm 0.3$ nH	5	100	4.2	5.1	0.55	0.32	250	MLG0603S6N2□T
6.8	$\pm 3, \pm 5\%$	5	100	3.6	4.4	0.6	0.32	250	MLG0603S6N8□T
7.5	$\pm 3, \pm 5\%$	5	100	4.2	5.3	0.7	0.43	200	MLG0603S7N5□T
8.2	$\pm 3, \pm 5\%$	5	100	3.8	4.5	0.7	0.45	200	MLG0603S8N2□T
9.1	$\pm 3, \pm 5\%$	5	100	3.4	4.9	0.8	0.51	200	MLG0603S9N1□T
10	$\pm 3, \pm 5\%$	5	100	3.2	4.1	0.8	0.53	200	MLG0603S10N□T
11	$\pm 3, \pm 5\%$	6	100	3.0	3.7	0.8	0.53	200	MLG0603S11N□T
12	$\pm 3, \pm 5\%$	6	100	2.8	3.6	0.9	0.63	180	MLG0603S12N□T
13	$\pm 3, \pm 5\%$	6	100	2.7	3.4	0.9	0.60	180	MLG0603S13N□T
15	$\pm 3, \pm 5\%$	6	100	2.5	3.3	1.1	0.69	180	MLG0603S15N□T
16	$\pm 3, \pm 5\%$	6	100	2.3	3.0	1.1	0.70	180	MLG0603S16N□T
18	$\pm 3, \pm 5\%$	6	100	2.2	2.8	1.2	0.78	150	MLG0603S18N□T
20	$\pm 3, \pm 5\%$	6	100	2.1	2.6	1.2	0.75	150	MLG0603S20N□T
22	$\pm 3, \pm 5\%$	6	100	2.0	2.5	1.2	0.88	150	MLG0603S22N□T
24	$\pm 3, \pm 5\%$	6	100	1.9	2.3	1.3	0.90	150	MLG0603S24N□T
27	$\pm 3, \pm 5\%$	6	100	1.8	2.2	1.5	1.00	100	MLG0603S27N□T
30	$\pm 3, \pm 5\%$	6	100	1.6	2.0	1.6	0.95	100	MLG0603S30N□T
33	$\pm 3, \pm 5\%$	6	100	1.6	2.0	1.8	1.20	100	MLG0603S33N□T
36	$\pm 3, \pm 5\%$	6	100	1.5	1.8	2.0	1.68	50	MLG0603S36N□T
39	$\pm 3, \pm 5\%$	6	100	1.4	1.6	2.0	1.40	50	MLG0603S39N□T
43	$\pm 3, \pm 5\%$	6	100	1.3	1.6	2.2	1.91	50	MLG0603S43N□T
47	$\pm 3, \pm 5\%$	6	100	1.3	1.5	2.2	1.48	50	MLG0603S47N□T
51	$\pm 3, \pm 5\%$	5	100	1.2	1.5	2.8	1.98	50	MLG0603S51N□T
56	$\pm 3, \pm 5\%$	5	100	1.2	1.4	3.2	2.11	50	MLG0603S56N□T
62	$\pm 3, \pm 5\%$	5	100	1.1	1.3	3.3	2.22	50	MLG0603S62N□T
68	$\pm 3, \pm 5\%$	5	100	1.05	1.2	3.5	2.40	50	MLG0603S68N□T
75	$\pm 3, \pm 5\%$	5	100	0.95	1.2	3.8	2.67	50	MLG0603S75N□T
82	$\pm 3, \pm 5\%$	5	100	0.90	1.1	4.0	2.80	50	MLG0603S82N□T
91	$\pm 3, \pm 5\%$	5	100	0.77	0.9	4.3	2.97	50	MLG0603S91N□T
100	$\pm 3, \pm 5\%$	5	100	0.77	0.9	4.5	3.13	50	MLG0603SR10□T

* □: Please specify inductance tolerance, B (± 0.1 nH), C (± 0.2 nH), S (± 0.3 nH), H ($\pm 3\%$) or J ($\pm 5\%$).

Please contact us for information on inductance tolerance, G ($\pm 2\%$).

- Test equipment

- Inductance Q : HP4291A+16197A, or equivalent

- SRF: HP8720C, or equivalent

- Rdc: YOKOGAWA TYPE7561, or equivalent

• All specifications are subject to change without notice.

L, Q vs. FREQUENCY CHARACTERISTICS

Part No.	Inductance(nH)typ.					Q typ.				
	500MHz	800MHz	1.8GHz	2.0GHz	2.4GHz	500MHz	800MHz	1.8GHz	2.0GHz	2.4GHz
MLG0603S0N3	0.3	0.3	0.3	0.3	0.3	14.5	19.9	34.1	34.8	40.4
MLG0603S0N4	0.4	0.4	0.4	0.4	0.4	14.0	18.9	30.1	32.1	35.9
MLG0603S0N5	0.5	0.5	0.45	0.45	0.45	14.1	18.4	29.3	31.7	35.4
MLG0603S0N6	0.6	0.6	0.5	0.5	0.5	15.6	19.8	32.8	34.2	38.6
MLG0603S0N7	0.7	0.6	0.6	0.6	0.6	16.3	21.4	33.1	34.7	38.6
MLG0603S0N8	0.7	0.7	0.7	0.7	0.7	15.4	20.4	32.1	34.1	37.8
MLG0603S0N9	0.8	0.8	0.8	0.8	0.8	15.1	19.3	30.1	31.8	35.3
MLG0603S1N0	0.9	0.9	0.9	0.9	0.9	14.3	18.3	28.8	30.3	33.8
MLG0603S1N1	1.0	1.0	1.0	1.0	1.0	14.4	18.7	29.1	30.5	34.1
MLG0603S1N2	1.1	1.1	1.1	1.1	1.1	14.2	18.3	28.6	30.3	33.5
MLG0603S1N3	1.2	1.2	1.2	1.2	1.2	14.3	18.3	28.6	30.0	33.2
MLG0603S1N5	1.4	1.4	1.4	1.4	1.4	14.8	18.8	29.0	30.4	33.5
MLG0603S1N6	1.5	1.5	1.5	1.5	1.5	14.3	18.4	28.6	30.1	33.4
MLG0603S1N8	1.7	1.7	1.7	1.7	1.7	14.7	18.9	28.7	30.1	33.1
MLG0603S2N0	1.9	1.9	1.9	1.9	1.9	13.9	18.0	27.7	29.2	32.2
MLG0603S2N2	2.1	2.0	2.1	2.1	2.1	13.8	17.7	26.8	27.9	30.7
MLG0603S2N4	2.2	2.2	2.2	2.3	2.3	13.9	17.9	27.4	28.5	31.5
MLG0603S2N7	2.5	2.5	2.6	2.6	2.7	14.6	18.6	27.8	28.8	31.4
MLG0603S3N0	2.8	2.8	2.9	2.9	3.0	15.1	19.4	29.4	30.6	33.4
MLG0603S3N3	3.1	3.1	3.2	3.3	3.4	15.1	19.2	28.2	29.2	31.4
MLG0603S3N6	3.4	3.4	3.5	3.6	3.7	13.8	17.8	26.2	27.0	29.0
MLG0603S3N9	3.7	3.7	3.8	3.9	4.1	15.1	19.4	28.5	29.4	31.6
MLG0603S4N3	4.1	4.1	4.3	4.4	4.6	14.3	18.3	26.5	27.3	28.9
MLG0603S4N7	4.4	4.4	4.8	4.9	5.2	15.2	19.5	27.9	28.6	30.1
MLG0603S5N1	4.8	4.8	5.1	5.3	5.6	13.8	17.5	25.0	25.5	26.7
MLG0603S5N6	5.3	5.3	5.7	5.9	6.4	15.5	19.6	27.2	27.8	28.8
MLG0603S6N2	5.9	5.9	6.5	6.8	7.5	14.5	18.3	25.1	25.4	25.7
MLG0603S6N8	6.4	6.5	7.4	7.8	8.7	15.4	19.4	25.7	25.7	25.3
MLG0603S7N5	7.1	7.1	7.8	8.0	8.7	14.2	18.0	25.2	25.6	26.4
MLG0603S8N2	7.8	7.8	8.8	9.3	10.4	14.7	18.2	23.9	24.0	23.6
MLG0603S9N1	8.6	8.6	9.8	10.3	11.5	13.5	16.9	22.2	22.3	21.8
MLG0603S10N	9.5	9.6	11.5	12.3	14.5	14.9	18.4	22.8	22.4	20.8
MLG0603S11N	10.4	10.5	12.6	13.6	16.1	14.5	17.8	22.1	21.7	20.0
MLG0603S12N	11.4	11.7	14.2	15.4	18.7	15.6	19.3	23.5	22.7	20.4
MLG0603S13N	12.2	12.5	15.6	17.2	21.6	13.6	16.3	18.7	17.9	15.3
MLG0603S15N	14.4	14.8	20.1	23.0	32.6	15.2	18.5	19.9	18.3	13.9
MLG0603S16N	15.1	15.6	21.7	25.1	37.2	13.5	15.9	16.4	14.8	10.7
MLG0603S18N	17.3	18.0	28.3	35.3	72.3	14.2	17.0	15.4	12.9	6.7
MLG0603S20N	19.1	20.0	32.4	41.6	101.9	13.4	15.6	13.5	11.0	4.7
MLG0603S22N	21.3	22.5	40.4	55.8	231.8	14.8	17.3	13.4	10.1	2.1
MLG0603S24N	23.0	24.3	44.7	63.6	103.9	13.1	15.3	12.8	10.2	
MLG0603S27N	26.5	28.6	68.3	130.9		14.6	16.7	9.3	4.9	
MLG0603S30N	29.3	32.1	110.7			13.1	14.5	5.5	0.6	
MLG0603S33N	32.6	36.0	144.5			14.2	15.9	5.2	0.5	
MLG0603S36N	36.0	40.2	254.6			14.0	15.1	2.8		
MLG0603S39N	39.5	46.5				13.1	13.7			
MLG0603S43N	44.4	53.1				13.5	13.6			
MLG0603S47N	48.6	59.5				12.8	12.5			
MLG0603S51N	52.2	63.8				11.0	10.7			
MLG0603S56N	59.2	77.2				12.0	10.9			
MLG0603S62N	66.1	88.2				11.3	9.9			
MLG0603S68N	74.4	103.9				12.5	10.7			
MLG0603S75N	81.8	119.1				10.3	8.3			
MLG0603S82N	95.5	161.3				11.8	8.2			
MLG0603S91N	109.1	228.6				8.8	4.8			
MLG0603SR10	129.3	353.5				10.5	4.4			

TYPICAL ELECTRICAL CHARACTERISTICS INDUCTANCE vs. FREQUENCY CHARACTERISTICS

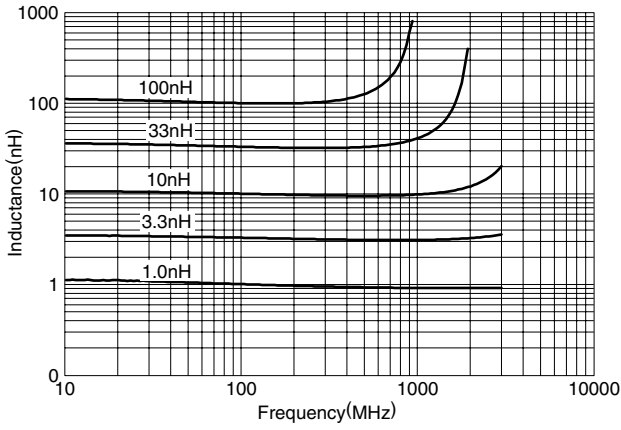

Q vs. FREQUENCY CHARACTERISTICS

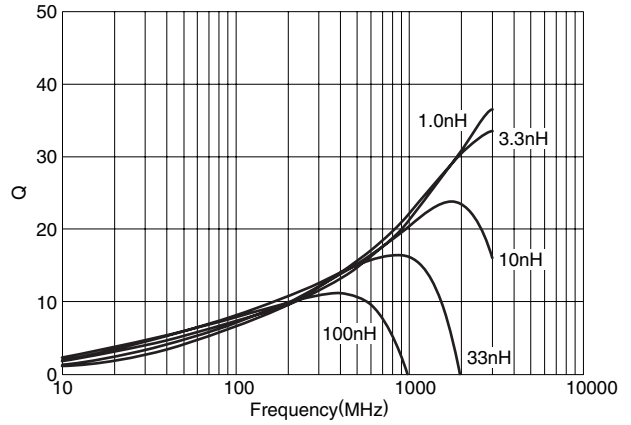

PACKAGING STYLES REEL DIMENSIONS

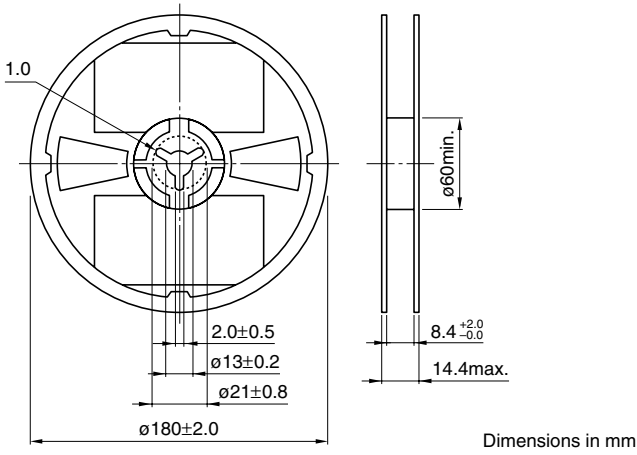

TAPE DIMENSIONS

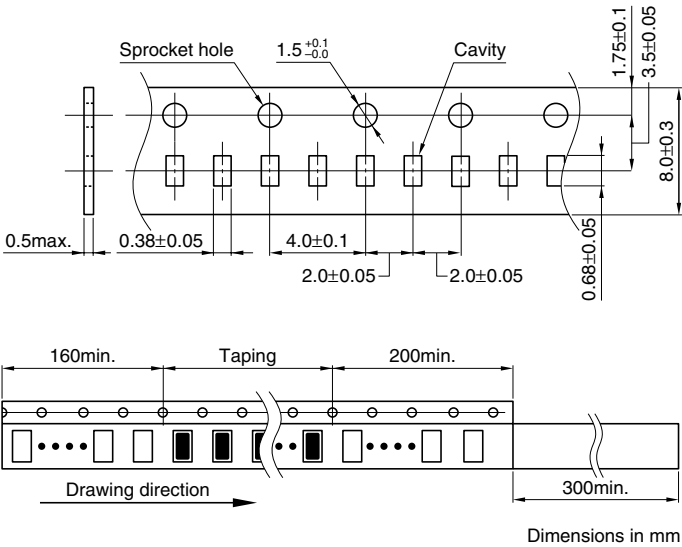

• All specifications are subject to change without notice.