



M8257

PROGRAMMABLE DMA CONTROLLER

Military

- Military Temperature Range:**
-55°C to +125°C (T_{CASE})
- Terminal Count and Modulo 128 Outputs**
- 4-Channel DMA Controller**
- Single TTL Clock**
- Priority DMA Request Logic**
- Single +5V Supply**
- Channel Inhibit Logic**
- Auto Load Mode**

The Intel M8257 is a 4-channel direct memory access (DMA) controller. It is specifically designed to simplify the transfer of data at high speeds for the Intel microcomputer systems. Its primary function is to generate, upon a peripheral request, a sequential memory address which will allow the peripheral to read or write data directly to or from memory. Acquisition of the system bus is accomplished via the CPU's hold function. The M8257 has priority logic that resolves the peripherals requests and issues a composite hold request to the CPU. It maintains the DMA cycle count for each channel and outputs a control signal to notify the peripheral that the programmed number of DMA cycles is complete. Other output control signals simplify sectorized data transfers. The M8257 represents a significant savings in component count for DMA-based microcomputer systems and greatly simplifies the transfer of data at high speed between peripherals and memories.

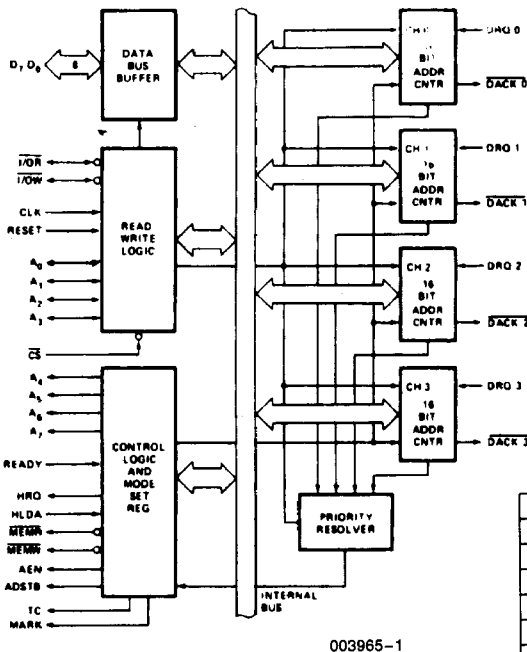

003965-1
Figure 1. Block Diagram

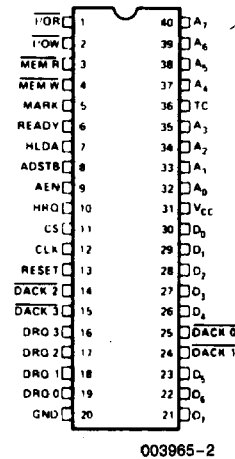

003965-2

D7-D0	Data Bus
A7-A0	Address Bus
I/O R	I/O Read
I/O W	I/O Write
MEMR	Memory Read
MEMW	Memory Write
CLK	Clock Input
RESET	Reset Input
READY	Ready
HRQ	Hold Request (To M8080A)
HLDA	Hold Acknowledge (From M8080A)

AEN	Address Enable
ADSTB	Address Strobe
TC	Terminal Count
MARK	Modulo 128 Mark
DRQ ₃ -DRQ ₀	DMA Request Input
DACK ₃ -DACK ₀	DMA Acknowledge Out
CS	Chip Select
V _{CC}	+5 Volts
GND	Ground

Figure 2. Pin Configuration

17

ABSOLUTE MAXIMUM RATINGS*

Case Temperature	
Under Bias ⁽¹⁾	-55°C to +125°C
Storage Temperature	-65°C to +150°C
Voltage on Any Pin	
With Respect to Ground	-0.5 to +7V
Power Dissipation.....	1.0W

NOTICE: This is a production data sheet. The specifications are subject to change without notice.

**WARNING: Stressing the device beyond the "Absolute Maximum Ratings" may cause permanent damage. These are stress ratings only. Operation beyond the "Operating Conditions" is not recommended and extended exposure beyond the "Operating Conditions" may affect device reliability.*

OPERATING CONDITIONS

Symbol	Parameter	Min	Max	Units
T _C	Case Temperature (Instant On)	-55	+125	°C
V _{CC}	Digital Supply Voltage	4.50	5.50	V

D.C. CHARACTERISTICS (Over Specified Operating Conditions)

Symbol	Parameter	Min	Max	Unit	Comments
V _{IL}	Input Low Voltage	-0.5	0.8	V	
V _{IH}	Input High Voltage	2.2	V _{CC} + 0.5	V	
V _{OL}	Output Low Voltage		0.45	V	I _{OL} = 1.6 mA
V _{OH}	Output High Voltage	2.4	V _{CC}	V	I _{OH} = -150 μA for AB, DB and AEN I _{OH} = -80 μA for Others
V _{HH}	HRQ Output High Voltage	3.3	V _{CC}	V	I _{OH} = -80 μA
I _{CC}	V _{CC} Current Drain		150	mA	
I _{IL}	Input Leakage		±10	μA	V _{SS} ≤ V _{IN} ≤ V _{CC}
I _{OFL}	Output Leakage During Float		±10	μA	V _{SS} + 0.45 ≤ V _{OUT} ≤ V _{CC}

CAPACITANCE T_C = 25°C, V_{CC} = GND = 0V

Symbol	Parameter	Min	Typ	Max	Unit	Comments
C _{IN}	Input Capacitance			10	pF	f _c = 1 MHz Unmeasured Pins Returned to GND
C _{I/O}	I/O Capacitance			20	pF	

A.C. CHARACTERISTICS—DMA (MASTER) MODE

(Over Specified Operating Conditions)

TIMING REQUIREMENTS

Symbol	Parameter	Min	Max	Unit
T _{CY}	Cycle Time (Period)	0.320	4	μs
T _θ	Clock Active (High)	120	0.8 T _{CY}	ns
T _{QS}	DRQ ↑ Setup to θ ↓ (S1, S4)	120		ns
T _{QH}	DRQ ↓ Hold from HLDA ↑ ⁽⁴⁾	0		ns
T _{HS}	HLDA ↑ or ↓ Setup to θ ↓ (S1, S4)	100		ns
T _{RS}	READY Setup Time to θ ↑ (S3, Sw)	30		ns
T _{RH}	READY Hold Time from θ ↑ (S3, Sw)	30		ns

A.C. CHARACTERISTICS—DMA (MASTER) MODE

(Over Specified Operating Conditions)

TIMING RESPONSES

Symbol	Parameter	Min	Max	Unit
T_{DQ}	HRQ \uparrow or \downarrow Delay from $\theta \uparrow$ (S1, S4) (Measured at 2.0V) ⁽¹⁾		180	ns
T_{DQ1}	HRQ \uparrow or \downarrow Delay from $\theta \uparrow$ (S1, S4) (Measured at 3.3V) ⁽³⁾		270	ns
T_{AEL}	AEN \uparrow Delay from $\theta \downarrow$ (S1) ⁽¹⁾		300	ns
T_{AET}	AEN \downarrow Delay from $\theta \uparrow$ (S1) ⁽¹⁾		200	ns
T_{AEA}	Adr(AB)(Active) Delay from AEN \uparrow (S1) ⁽⁴⁾	20		ns
T_{FAAB}	Adr(AB)(Active) Delay from $\theta \uparrow$ (S1) ⁽²⁾		270	ns
T_{AFAB}	Adr(AB)(Float) Delay from $\theta \uparrow$ (S1) ⁽²⁾		200	ns
T_{ASM}	Adr(AB)(Stable) Delay from $\theta \uparrow$ (S1) ⁽²⁾		250	ns
T_{AH}	Adr(AB)(Stable) Hold from $\theta \uparrow$ (S1) ⁽²⁾	$T_{ASM} - 50$		ns
T_{AHR}	Adr(AB)(Valid) Hold from $\overline{Rd} \uparrow$ (S1, S1) ⁽⁴⁾	60		ns
T_{AHW}	Adr(AB)(Valid) Hold from $\overline{Wr} \uparrow$ (S1, S1) ⁽⁴⁾	300		ns
T_{FADB}	Adr(DB)(Active) Delay from $\theta \uparrow$ (S1) ⁽²⁾		300	ns
T_{AFDB}	Adr(DB)(Float) Delay from $\theta \uparrow$ (S2) ⁽²⁾	$T_{STT} + 20$	250	ns
T_{ASS}	Adr(DB) Setup to AdrStb \downarrow (S1–S2) ⁽⁴⁾	100		ns
T_{AHS}	Adr(DB)(Valid) Hold from AdrStb \downarrow (S2) ⁽⁴⁾	50		ns
T_{STL}	AdrStb \uparrow Delay from $\theta \uparrow$ (S1) ⁽¹⁾		200	ns
T_{STT}	AdrStb \downarrow Delay from $\theta \uparrow$ (S2) ⁽¹⁾		160	ns
T_{SW}	AdrStb Width (S1–S2) ⁽⁴⁾	$T_{CY} - 100$		ns
T_{ASC}	$\overline{Rd} \downarrow$ or $\overline{Wr}(\text{Ext}) \downarrow$ Delay from AdrStb \downarrow (S2) ⁽⁴⁾	70		ns
T_{DBC}	$\overline{Rd} \downarrow$ or $\overline{Wr}(\text{Ext}) \downarrow$ Delay from Adr(DB) (Float)(S2) ⁽⁴⁾	20		ns
T_{AK}	DACK \uparrow or \downarrow Delay from $\theta \downarrow$ (S2, S1) and TC/Mark \uparrow Delay from $\theta \uparrow$ (S3) and TC/Mark \downarrow Delay from $\theta \uparrow$ (S4) ⁽¹⁾⁽⁵⁾		270	ns
T_{DCL}	$\overline{Rd} \downarrow$ or $\overline{Wr}(\text{Ext}) \downarrow$ Delay from $\theta \uparrow$ (S2) and $\overline{Wr} \downarrow$ Delay from $\theta \uparrow$ (S3) ⁽²⁾⁽⁶⁾		250	ns
T_{DCT}	$\overline{Rd} \uparrow$ Delay from $\theta \downarrow$ (S1, S1) and $\overline{Wr} \uparrow$ Delay from $\theta \uparrow$ (S4) ⁽²⁾⁽⁷⁾		200	ns
T_{FAC}	\overline{Rd} or $\overline{Wr}(\text{Active})$ from $\theta \uparrow$ (S1) ⁽²⁾		300	ns
T_{AFC}	\overline{Rd} or $\overline{Wr}(\text{Float})$ from $\theta \uparrow$ (S1) ⁽²⁾		170	ns
T_{RWM}	\overline{Rd} Width (S2–S1 or S1) ⁽⁴⁾	$2T_{CY} + T_{\theta} - 50$		ns
T_{WWM}	\overline{Wr} Width (S3–S4) ⁽⁴⁾	$T_{CY} - 50$		ns
T_{WVME}	$\overline{Wr}(\text{Ext})$ Width (S2–S4) ⁽⁴⁾	$2T_{CY} - 50$		ns

NOTES:

1. Load = 1 TTL.
2. Load = 1 TTL + 50 pF.
3. Load = 1 TTL + (R_L = 3.3K), V_{OH} = 3.3V.
4. Tracking Parameter.

5. $\Delta T_{AK} < 50$ ns.
6. $\Delta T_{DCL} < 50$ ns.
7. $\Delta T_{DCT} < 50$ ns.

A.C. CHARACTERISTICS—PERIPHERAL (SLAVE) MODE

(Over Specified Operating Conditions)

M8080A BUS PARAMETERS
READ CYCLE

Symbol	Parameter	Min	Max	Unit	Comments
T_{AR}	Adr or \overline{CS} ↓ Setup to \overline{RD} ↓	0		ns	
T_{RA}	Adr or \overline{CS} ↑ Hold from \overline{RD} ↑	0		ns	
T_{RD}	Data Access from \overline{RD} ↓	0	300	ns	(Note 2)
T_{DF}	DB → Float Delay from \overline{RD} ↑	20	150	ns	
T_{RR}	\overline{RD} Width	250		ns	

WRITE CYCLE

Symbol	Parameter	Min	Max	Unit	Comments
T_{AW}	Adr Setup to \overline{WR} ↓	20		ns	
T_{WA}	Adr Hold from \overline{WR} ↑	35		ns	
T_{DW}	Data Setup to \overline{WR} ↑	200		ns	
T_{WD}	Data Hold from \overline{WR} ↑	10		ns	
T_{WW}	\overline{WR} Width	175		ns	

OTHER TIMING

Symbol	Parameter	Min	Max	Unit	Comments
T_{RSTW}	Reset Pulse Width	300		ns	
T_{RSTD}	Power Supply ↑ (V_{CC}) Setup to Reset ↓	500		μs	
T_r	Signal Rise Time		20	ns	
T_f	Signal Fall Time		20	ns	
T_{RSTS}	Reset to First I/O \overline{WR}	2		t _{cy}	

NOTES:

1. All timing measurements are made at the following reference voltages unless specified otherwise:

Input "1" at 2.0V, "0" at 0.8V.

Output "1" at 2.0V, "0" at 0.8V.

 2. M8257: $C_L = 100$ pF.

TRACKING PARAMETERS

Signals labeled as Tracking Parameters (footnotes 4–7 under A.C. Specifications) are signals that follow similar paths through the silicon die. The propagation speed of these signals varies in the manufacturing process but the relationship between all these parameters is constant. The variation is less than or equal to 50 ns.

Suppose the following timing equation is being evaluated,

$$T_{A(MIN)} + T_{B(MAX)} \leq 150 \text{ ns}$$

and only minimum specifications exist for T_A and T_B . If $T_{A(MIN)}$ is used, and if T_A and T_B are tracking parameters, $T_{B(MAX)}$ can be taken as $T_{B(MIN)} + 50$ ns.

$$T_{A(MIN)} + (T_{B(MIN)} + 50 \text{ ns}) \leq 150 \text{ ns}$$

*If T_A and T_B are tracking parameters.

A.C. TESTING INPUT, OUTPUT WAVEFORM

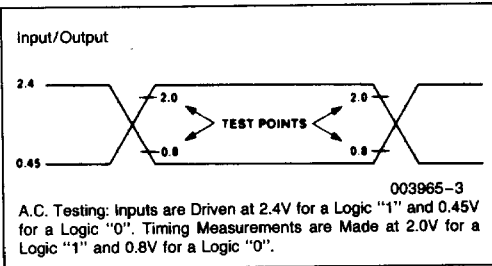

A.C. TESTING LOAD CIRCUIT

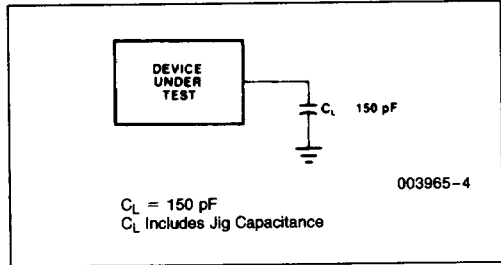

WAVEFORMS

NOT READY SEQUENCE

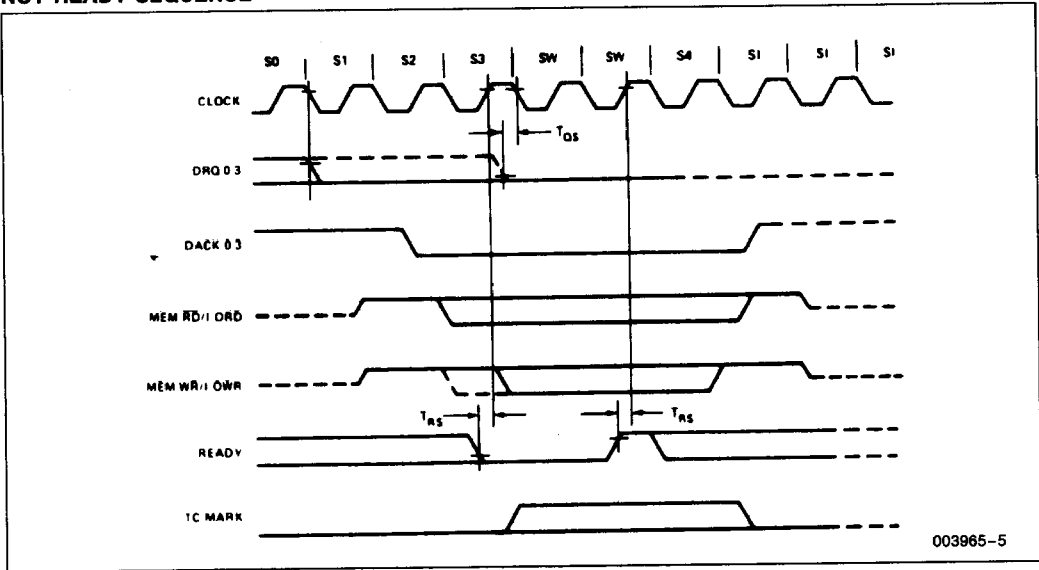

CONTROL OVERRIDE

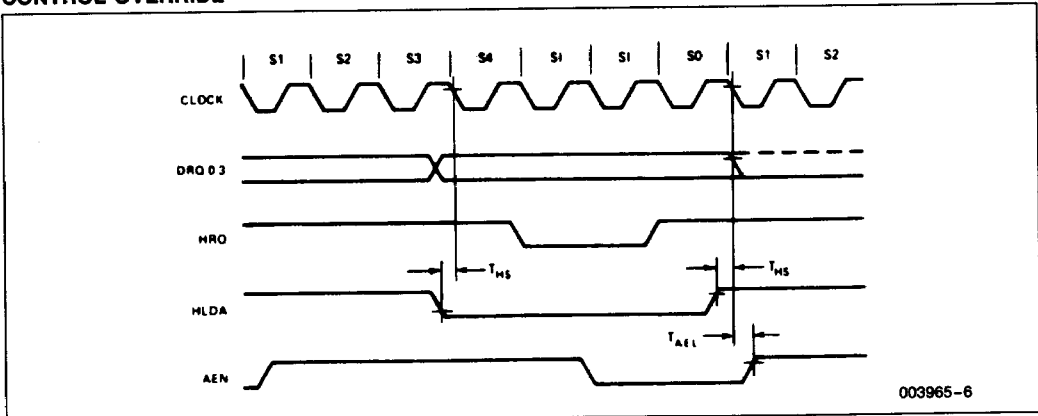

WAVEFORMS—DMA MODE

CONSECUTIVE CYCLES AND BURST MODE SEQUENCE

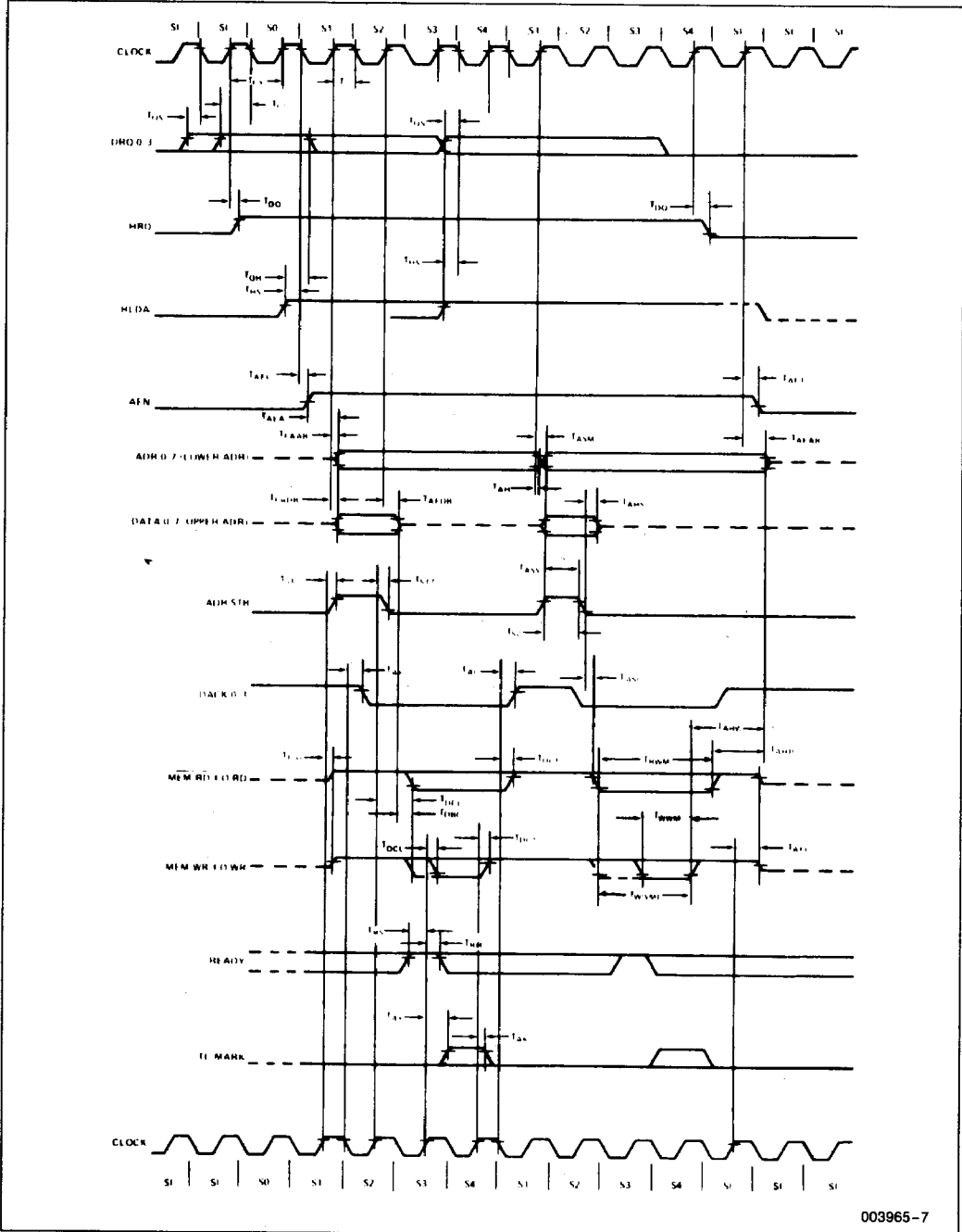

003965-7

NOTE:
The clock waveform is duplicated for clarity. The M8257 requires only one clock input.

WAVEFORMS—PERIPHERAL MODE

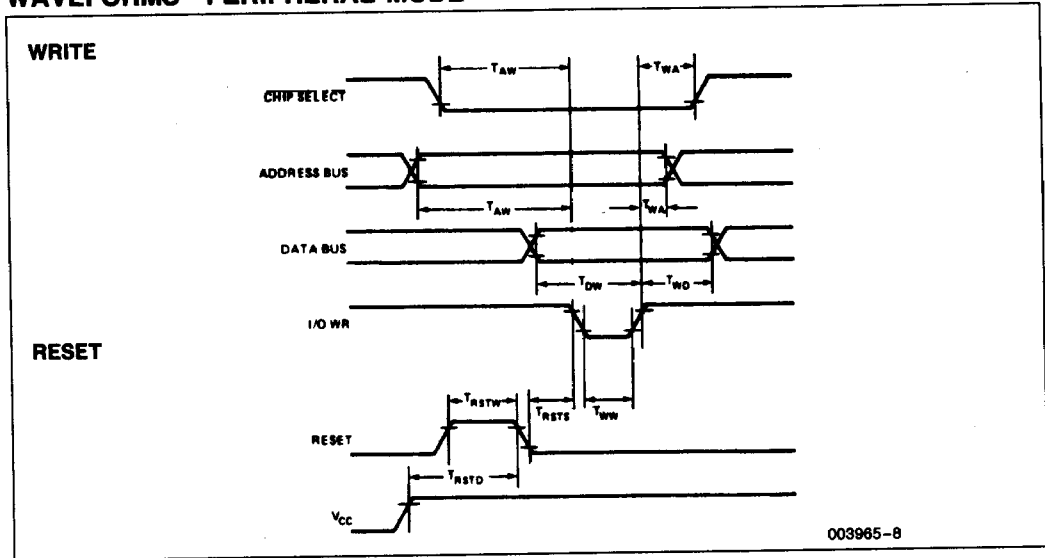

READ

