

THIS DRAWING IS UNPUBLISHED. RELEASED FOR PUBLICATION
 © COPYRIGHT BY TYCO ELECTRONICS CORPORATION. ALL INTERNATIONAL RIGHTS RESERVED.

| LOC | DIST | REVISIONS | | | |
|-----|------|-------------|---------------------------|---------|--------|
| P | LTR | DESCRIPTION | DATE | DWN | APVD |
| AD | 00 | D | REVISED PER ECO-08-027222 | 05NOV08 | HMR FD |

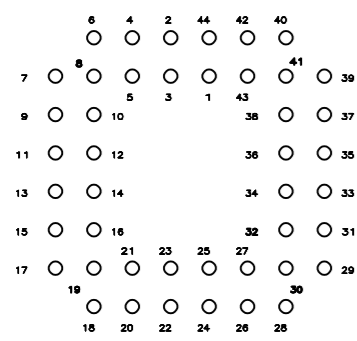

44 POS.

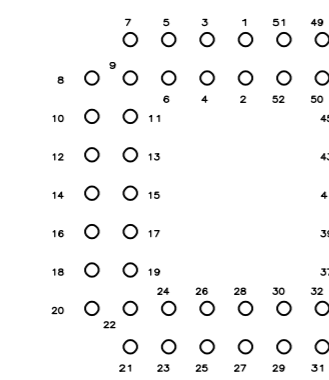

52 POS.

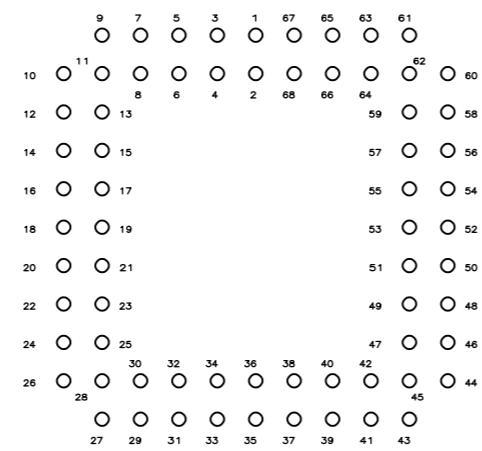

68 POS.

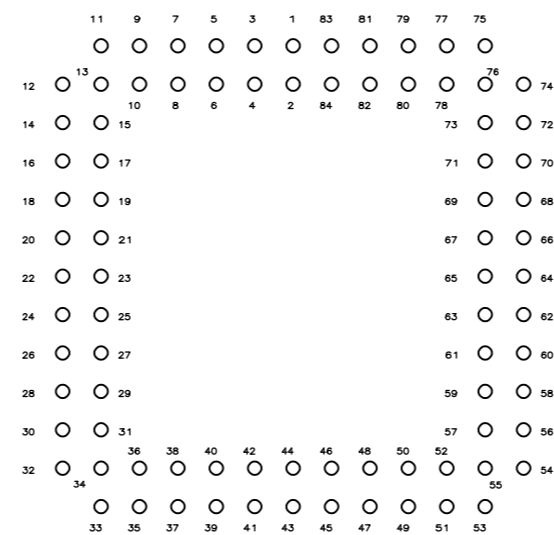

84 POS.

RECOMMENDED HOLE LAYOUT
 TOLERANCE: ±0.05[.002] UNLESS OTHERWISE NOTED

NOTES:

- 1 MATERIALS:
 CONTACT: COPPER ALLOY, 0.004572[.000180] MIN TIN PLATE
 OVER 0.00127[.000050] MIN NICKEL.
 INSULATOR: PPS, 40% GLASS FILLED, UL 94V-0

- 2 DATE CODE (PER BELOW) TO BE LASER CODED
 AND CENTERED ON THIS SURFACE.

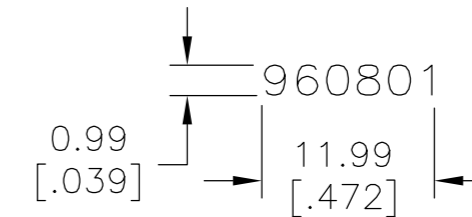

3. UL RECOGNITION E320916.

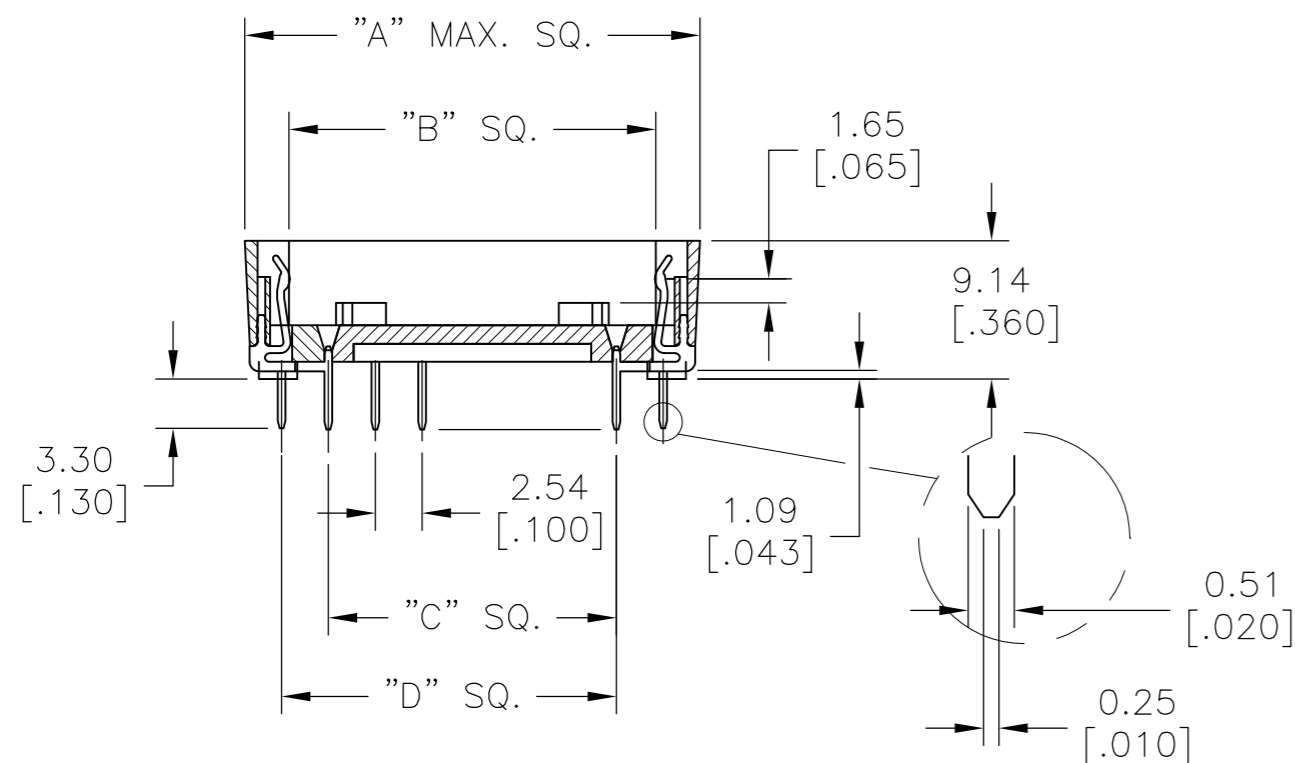
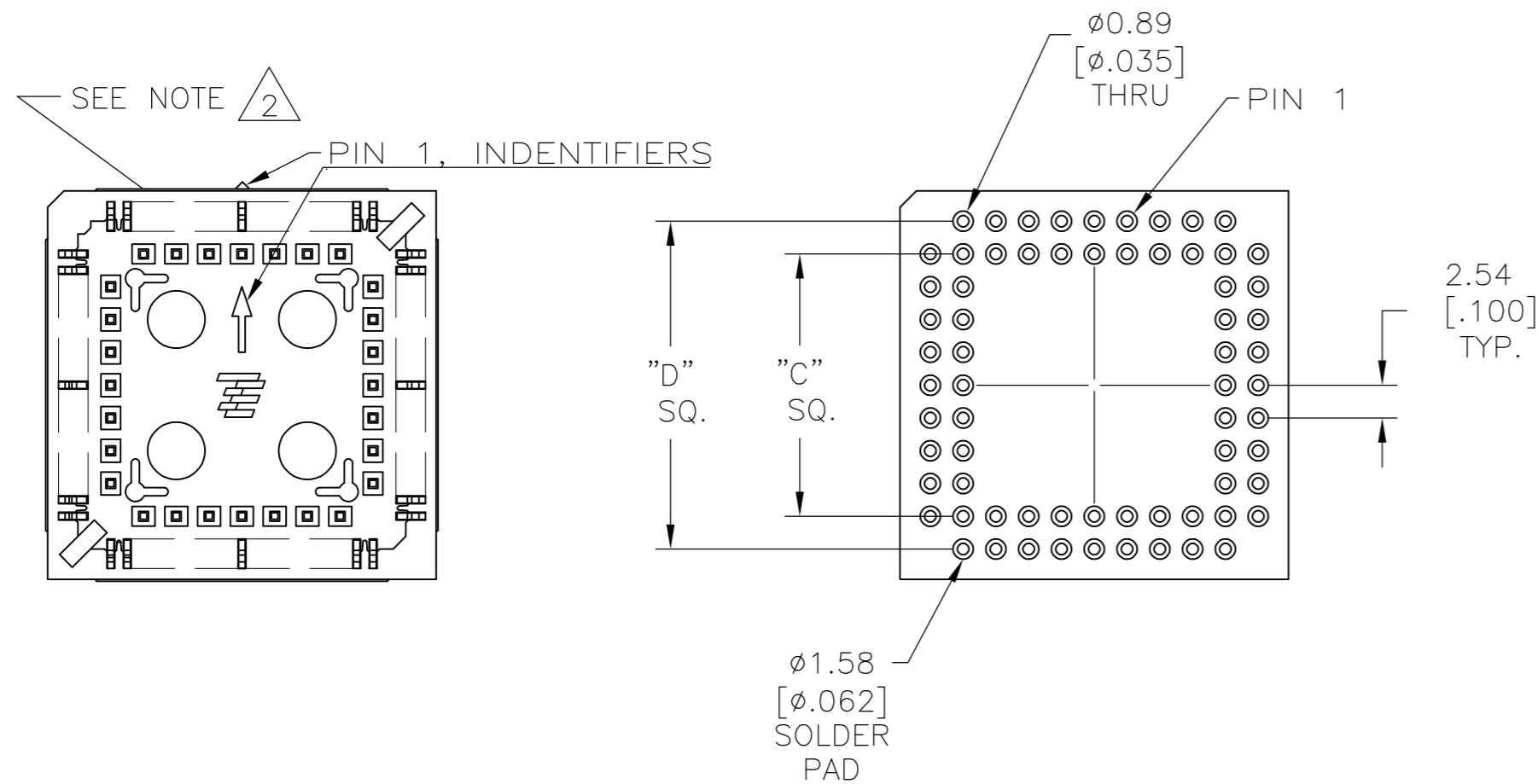

| PART NO. | POS. | DIM. "A" | DIM. "B" | DIM. "C" | DIM. "D" |
|-----------|------|------------------|------------------|------------------|------------------|
| 1571541-1 | 44 | 22.61 [.890] | 16.76 [.660] | 12.70 [.500] | 17.78 [.700] |
| 1571541-2 | 52 | 25.15 [.990] | 19.30 [.760] | 15.24 [.600] | 20.32 [.800] |
| 1571541-3 | 68 | 30.23 [1.190] | 24.38 [.960] | 20.32 [.800] | 25.40 [1.000] |
| 1571541-4 | 84 | 35.31 [1.390] | 29.46 [1.160] | 25.40 [1.000] | 30.48 [1.200] |

| | | | | | |
|--|---|-------------------------------|---|--------------------|-------------------------|
| THIS DRAWING IS A CONTROLLED DOCUMENT. | | DWN D. MURREN 26AUG2003 | Tyco Electronics Corporation Harrisburg, PA 17105-3608 | | |
| DIMENSIONS: mm [INCHES] | TOLERANCES UNLESS OTHERWISE SPECIFIED: | CHK K. WRIGHT 24APR03 | NAME OUTLINE DRAWING PLCC SOCKET | | |
| | 0 PLC ± - | APVD K. WRIGHT 24APR03 | PRODUCT SPEC 108-38000 | | |
| | 1 PLC ± 1 | APPLICATION SPEC | SIZE A2 | CAGE CODE 00779 | DRAWING NO C=1571541 |
| MATERIAL | FINISH | WEIGHT | SCALE 2:1 | SHEET 1 of 1 | RESTRICTED TO - |
| 1 | 1 | CUSTOMER DRAWING | REV D | | |