

●Features

- Nomal type and Low current type line-up.

●Size

2012 (0805)
2.0 × 1.25mm (t=0.8mm)



●Outline

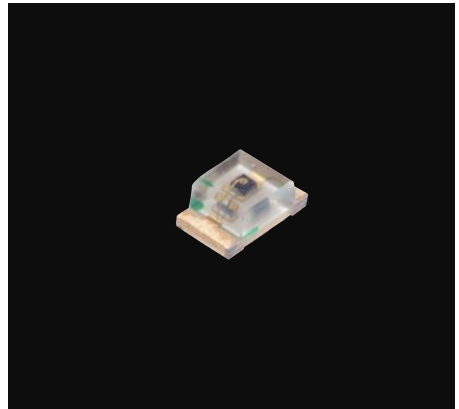

●Dimensions

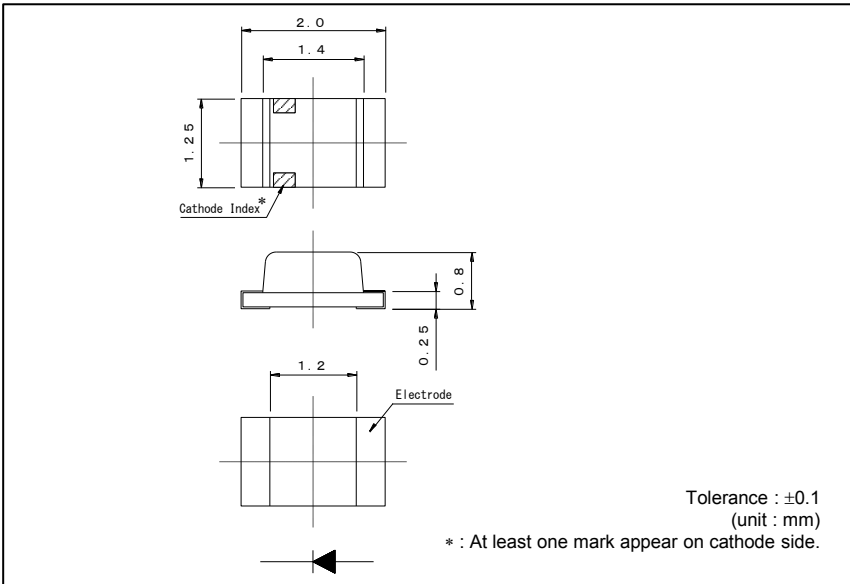

●Recommended Solder Pattern

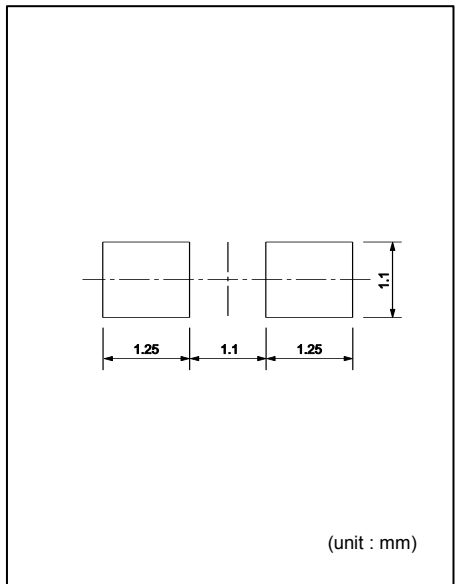

●Specifications

Part No.	Chip Structure	Emitting Color	Absolute Maximum Ratings (Ta=25°C)					Electrical and Optical Characteristics (Ta=25°C)																												
			Power Dissipation P _D (mW)	Forward Current I _F (mA)	Peak Forward Current I _{FP} (mA)	Reverse Voltage V _R (V)	Operating Temp. Topr(°C)	Storage Temp. Tstg(°C)	Forward Voltage V _F		Reverse Current I _R		Dominant Wavelength λ _D			Luminous Intensity I _v																				
									Typ. (V)	I _F (mA)	Max. (μA)	V _R (V)	Min.*3 (nm)	Typ.*3 (nm)	Max.*3 (nm)	I _F (mA)	Min. (mcd)	Typ. (mcd)	I _F (mA)																	
■ SML-212VT	AlGaInP on GaAs	Red	75	30	60*1	4	-30 to +85	-40 to +85	2.05	20	100	4	625	630	635	20	22	63	20																	
■ SML-212U2T(A)					100*2	5	-40 to +100	-40 to +100	2	20	10	5	611	615	619	2	71	140	20																	
■ SML-211UT			44	20					1.8	2			615	620	625	2	0.9	2.5	2																	
■ SML-212DT		Orange	75	30	60*1	4	-30 to +85	-40 to +85	2.05	20	100	4	602	605	608	2	0.9	2.5	2																	
■ SML-211DT																				44	20			1.8	2											
■ SML-212WT(A)		Yellow	75	30	100*2	5	-40 to +100	-40 to +100	2	20	10	5	587	590	593	2	1.4	4	2																	
■ SML-211WT																				44	20			1.8	2											
■ SML-212YT																				75	30	60*1	4	-30 to +85	-40 to +85	2.05	20	100	4	584	587	590	2	1.4	4	2
■ SML-211YT																																				

*1 : Duty1/5, 200Hz *2 : Duty1/10, 1kHz *3 : Reference

●Electrical Characteristics Curves

Fig.1 Forward Current - Forward Voltages

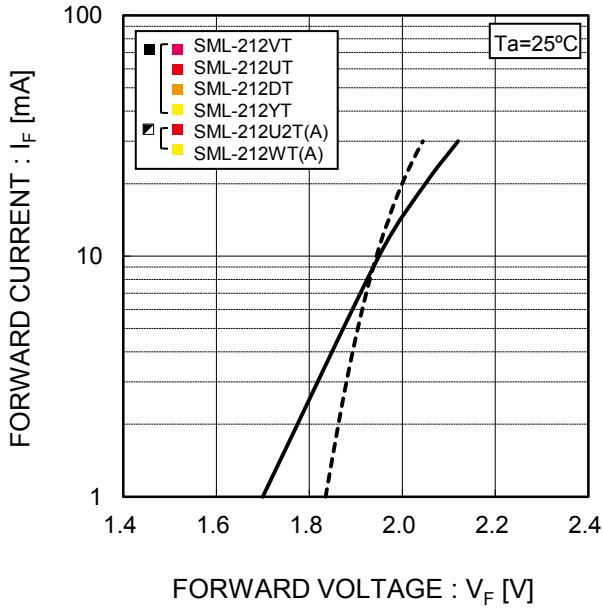

Fig.2 Luminous Intensity - Atmosphere Temperature

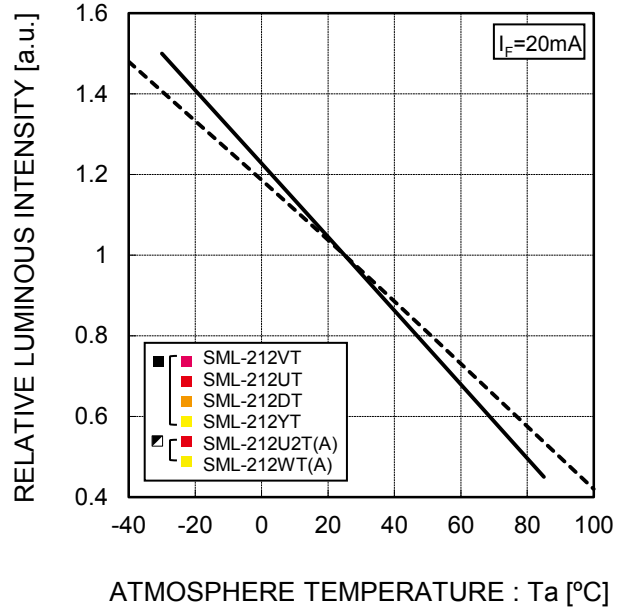

Fig.3 Luminous Intensity - Forward Current

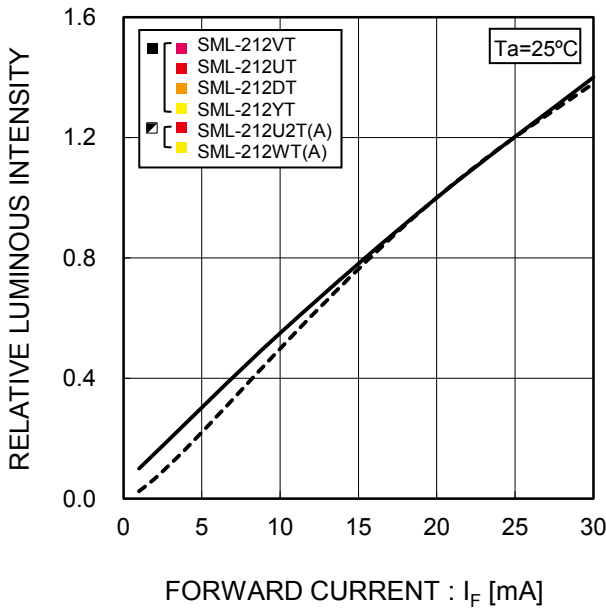
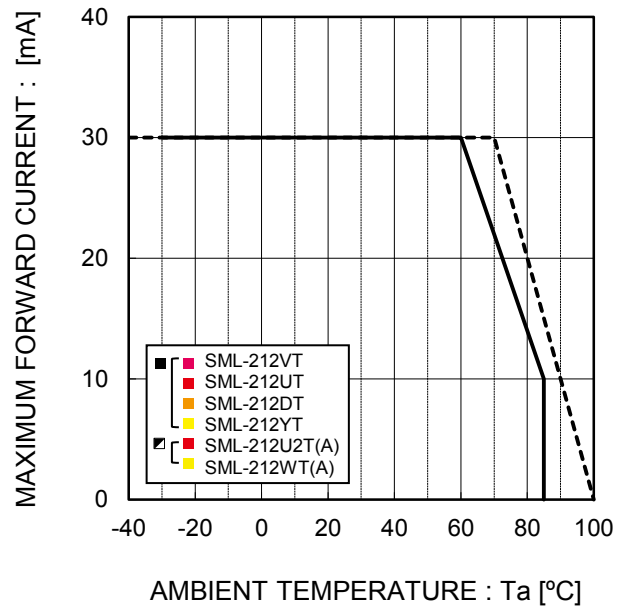

Fig.4 Derating



●Electrical Characteristics Curves

Fig.1 Forward Current - Forward Voltages

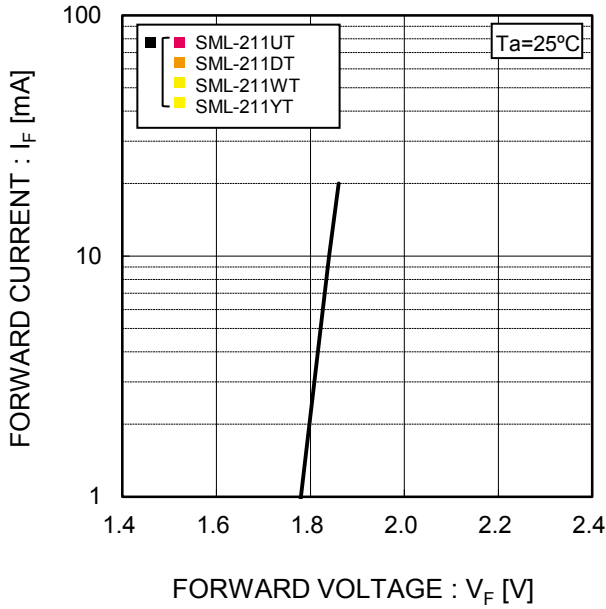

Fig.2 Luminous Intensity - Atmosphere Temperature

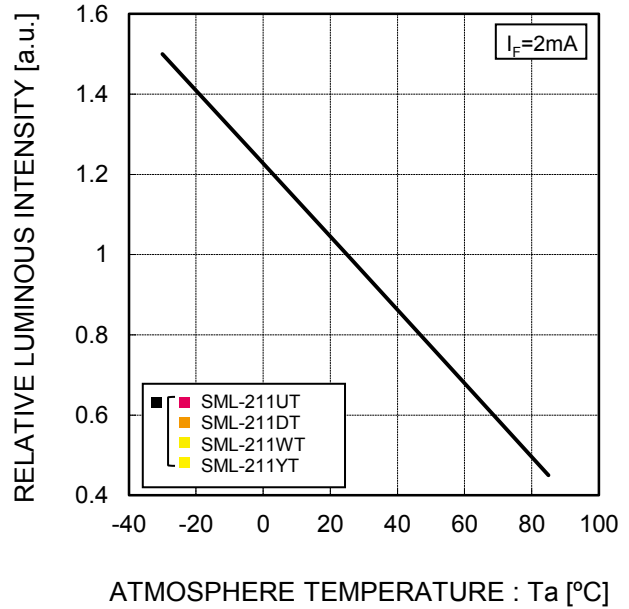

Fig.3 Luminous Intensity - Forward Current

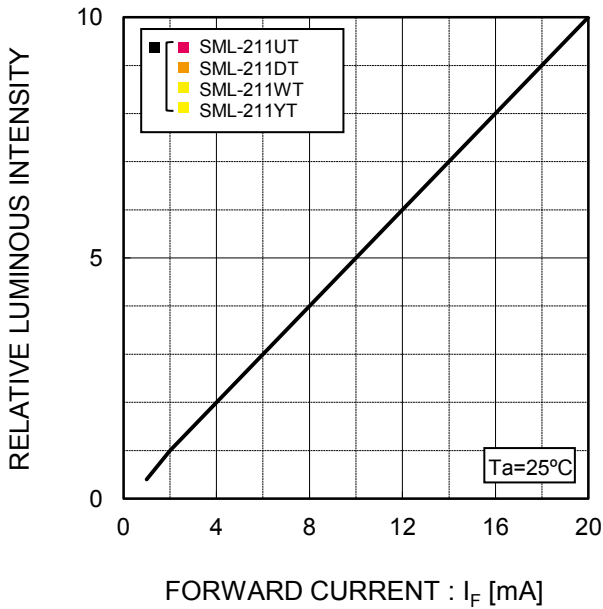
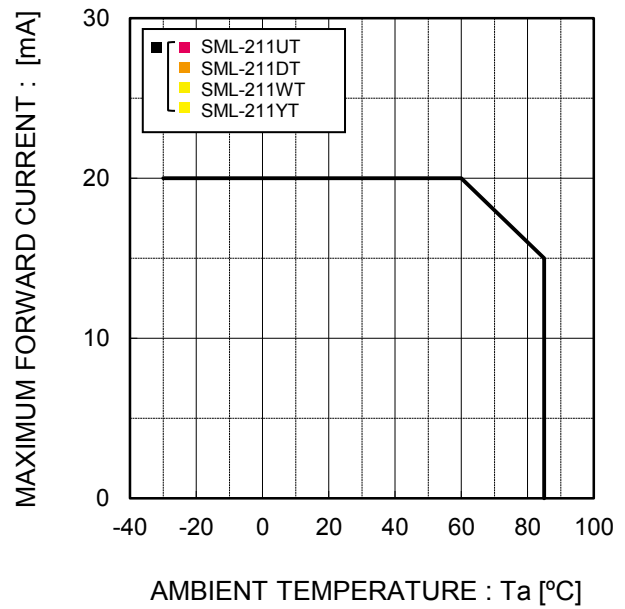
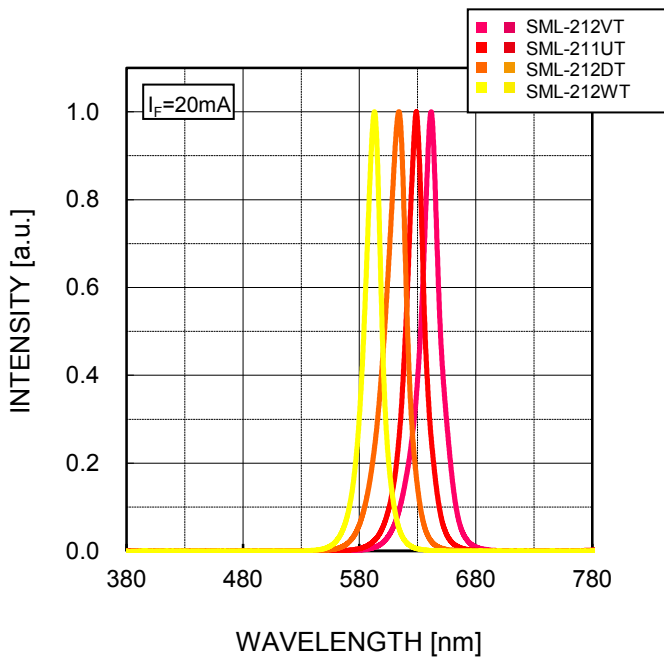

Fig.4 Derating



● Spectrum Data



* Please take this data as a reference data for the samples are measured randomly.
 * The data is relativized for each color. It is NOT to show the spectrum peaks are equal.

● Viewing Angle

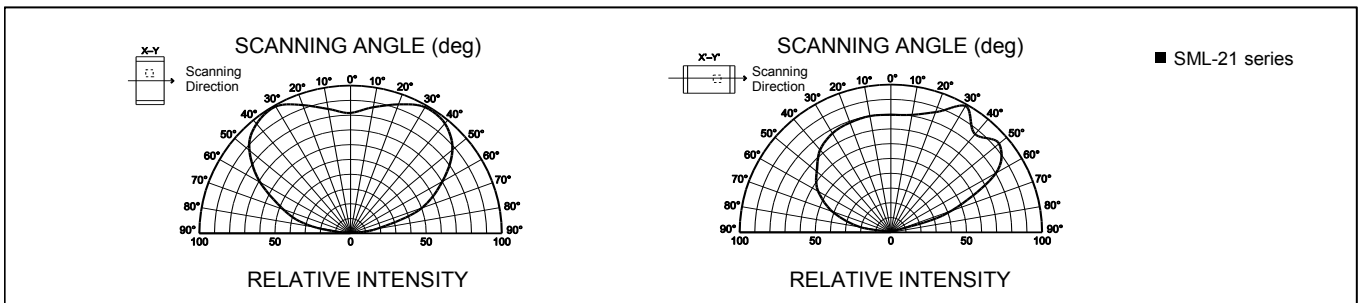

●Rank Reference of Brightness

Red(V,U)

(Ta=25°C, If=20mA, *1: If=2mA)

Rank	G	H	J	K	L	M	N	P	Q	R	S	T	U	V	W	X
Iv (mcd)	1.0 to 1.6	1.6 to 2.5	2.5 to 4.0	4.0 to 6.3	6.3 to 10	10 to 16	16 to 25	25 to 40	40 to 63	63 to 100	100 to 160	160 to 250	250 to 400	400 to 630	630 to 1000	1000 to 1600
SML-212VT*2																
SML-211UT*1																

(Ta=25°C, If=20mA)

Rank	AJ	AK	AL	AM	AN	AP	AQ	AR	AS	AT	AU	AV	AW	AX	AY	AZ
Iv (mcd)	14 to 18	18 to 22.4	22.4 to 28	28 to 35.5	35.5 to 45	45 to 56	56 to 71	71 to 90	90 to 112	112 to 140	140 to 180	180 to 224	224 to 280	280 to 355	280 to 355	355 to 450
SML-212U2T(A)																

Orange(D)

(Ta=25°C, If=20mA, *1: If=2mA)

Rank	G	H	J	K	L	M	N	P	Q	R	S	T	U	V	W	X
Iv (mcd)	1.0 to 1.6	1.6 to 2.5	2.5 to 4.0	4.0 to 6.3	6.3 to 10	10 to 16	16 to 25	25 to 40	40 to 63	63 to 100	100 to 160	160 to 250	250 to 400	400 to 630	630 to 1000	1000 to 1600
SML-212DT																
SML-211DT*1*2																

Yellow(Y,W)

(Ta=25°C, If=20mA, *1: If=2mA)

Rank	G	H	J	K	L	M	N	P	Q	R	S	T	U	V	W	X
Iv (mcd)	1.0 to 1.6	1.6 to 2.5	2.5 to 4.0	4.0 to 6.3	6.3 to 10	10 to 16	16 to 25	25 to 40	40 to 63	63 to 100	100 to 160	160 to 250	250 to 400	400 to 630	630 to 1000	1000 to 1600
SML-212YT																
SML-211YT*1*2																
SML-211WT*1*2																

(Ta=25°C, If=20mA)

Rank	AJ	AK	AL	AM	AN	AP	AQ	AR	AS	AT	AU	AV	AW	AX	AY	AZ
Iv (mcd)	14 to 18	18 to 22.4	22.4 to 28	28 to 35.5	35.5 to 45	45 to 56	56 to 71	71 to 90	90 to 112	112 to 140	140 to 180	180 to 224	224 to 280	280 to 355	280 to 355	355 to 450
SML-212WT(A)																

*2 : Brightness on specification sheet include tolerance of within ±10%.

●Taping

T86

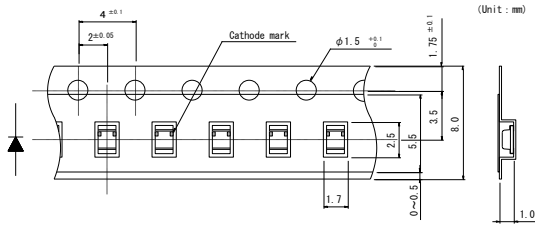

T87

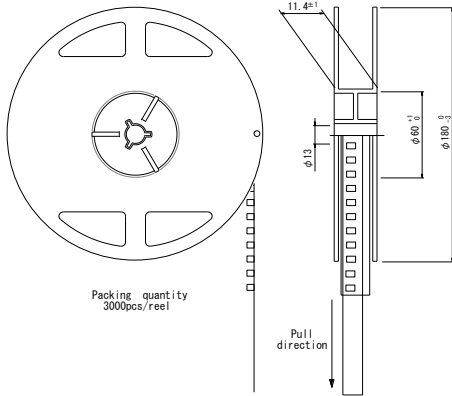
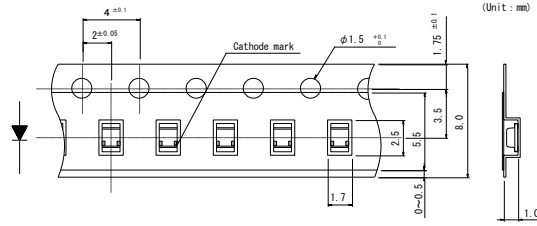

Packing quantity
3000pcs/reel

Pull direction

(note) Tolerance is within ±0.2mm
unless otherwise specified

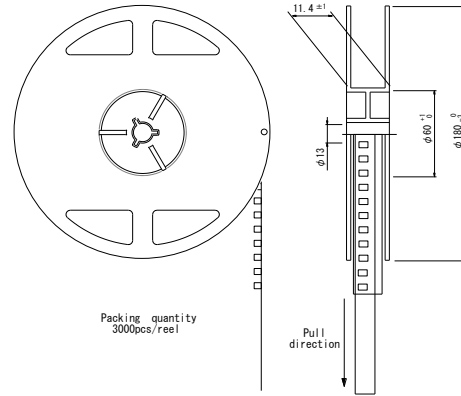

Packing quantity
3000pcs/reel

Pull direction

(note) Tolerance is within ±0.2mm
unless otherwise specified

●Part No. Construction

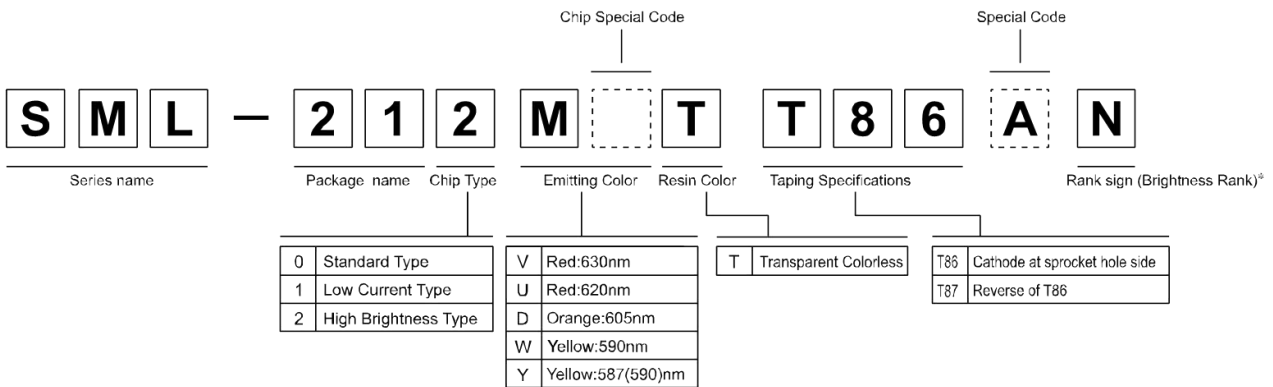

- Ⓔ Concerning the Brightness rank
- Please refer to the rank chart above for luminous intensity classification.
- Part name is individual for each rank.
- When shipped as sample, the part name will be a representative part name.
- General products are free of ranks. Please contact sales if rank appointment is needed.

●Packing Specification

ROHM LED products are being shipped with desiccant (silica gel) concluded in moisture-proof bags.

Pasting the moisture sensitive label on the outer surface of the moisture-proof bags or enclosing the humidity indication card inside the bag is available upon request.

Please contact the nearest sales office or distributor if necessary.

●Attention Points In Handling

This product was developed as a surface mount LED especially suitable for reflow soldering.
Please take care of following points when using this device.

1.DESIGNING OF PCB

As for a recommendable solder pattern, Please refer to Fig-1.

The size and direction of the pad pattern depends on the condition of the PCB,
So, please investigate about the adjustment thoroughly before designing.

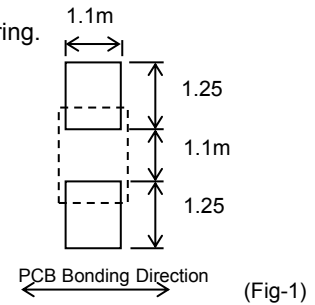

(Fig-1)

2.SOLDERING (Sn-Cu, Sn-Ag-Cu, Sn-Ag-Bi-Cu)

LED products do not contain reinforcement materials such as glass fillers.

Therefore, thermal stress by soldering greatly influences its reliability.

The temperature conditions for reflow soldering should therefore be set up according to the characteristic of this product. (See Fig-2)

Number of reflow process shall be max 2 times and these processes shall be performed in a row.
Cooling process to normal temperature shall be required between the first and the second soldering process.

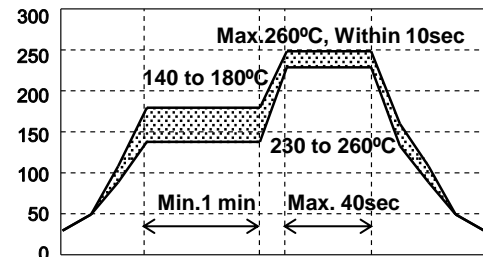

(Fig-2)

3.HANDLING AFTER MOUNTING

As shown right drawing, in case outside force of around 1kg is given to the device, stress is concentrated to the jointed part between mold resin and substrate.

Therefore there is a possibility to break the device or PCB.

Careful handling is needed as ROHM cannot guarantee the falling of the device by outside force after mounting.

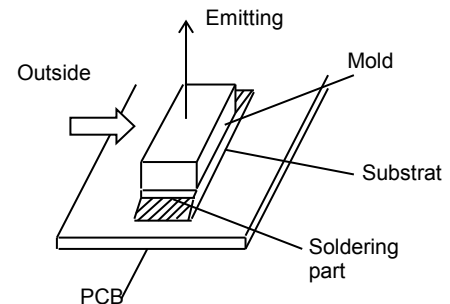

4.WASHING

Please note the following points when washing is required after soldering.

4-1) WASHING SOLVENT

Isopropyl alcohol or other alcohol solvent is recommendable.

4-2) TEMPERATURE

Below 30°C, immersion time ; within 3 minutes.

4-3) ULTRA SONIC WASHING

Below 15/1 liter of solvent tub.

4-4) COOLING

Below 100°C within 3 minutes.

5.EROSION GAS

Utilization in erosion gas atmosphere may degenerate the plating surface which might cause deterioration of solder strength, optical characteristics, or functions.

Please take precautions against occurrence of gas from the surrounding parts on the occasion of custody, and also after mounted on circuit board.

6.STORAGE

At reflow soldering, the reliability of this product is often influenced by moisture absorption so we apply the packaging with moisture proof for better condition is use, please also note that

6-1) Not to be opened before using.

6-2) To be kept in our moisture proof packaging with some desiccant (SILICA GEL) after opening it.

To be baked in case the SILICA GEL indicator its color from either blue to clear or green to pink.

6-3) Please use within 168 hours after the package was opened. (Condition at 30°C, max.70%Rh.)

In case it is not used within 168 hours, please put it back into our packaging.

6-4) BAKING

Please bake under reel condition at 60°C, 12 to 24 hours (max.20%Rh) after un-sealing.

While baking is done, the reel and emboss tape may be easily deformed.

Please be careful not to give any stress.

7.LIFE TIME

This product will cause reduction of luminous intensity depending on the using conditions and environmental.

Please inquire our sales contact if long life time is required on your application.

Notes

- 1) The information contained herein is subject to change without notice.
- 2) Before you use our Products, please contact our sales representative and verify the latest specifications :
- 3) Although ROHM is continuously working to improve product reliability and quality, semiconductors can break down and malfunction due to various factors.
Therefore, in order to prevent personal injury or fire arising from failure, please take safety measures such as complying with the derating characteristics, implementing redundant and fire prevention designs, and utilizing backups and fail-safe procedures. ROHM shall have no responsibility for any damages arising out of the use of our Products beyond the rating specified by ROHM.
- 4) Examples of application circuits, circuit constants and any other information contained herein are provided only to illustrate the standard usage and operations of the Products. The peripheral conditions must be taken into account when designing circuits for mass production.
- 5) The technical information specified herein is intended only to show the typical functions of and examples of application circuits for the Products. ROHM does not grant you, explicitly or implicitly, any license to use or exercise intellectual property or other rights held by ROHM or any other parties. ROHM shall have no responsibility whatsoever for any dispute arising out of the use of such technical information.
- 6) The Products are intended for use in general electronic equipment (i.e. AV/OA devices, communication, consumer systems, gaming/entertainment sets) as well as the applications indicated in this document.
- 7) The Products specified in this document are not designed to be radiation tolerant.
- 8) For use of our Products in applications requiring a high degree of reliability (as exemplified below), please contact and consult with a ROHM representative : transportation equipment (i.e. cars, ships, trains), primary communication equipment, traffic lights, fire/crime prevention, safety equipment, medical systems, servers, solar cells, and power transmission systems.
- 9) Do not use our Products in applications requiring extremely high reliability, such as aerospace equipment, nuclear power control systems, and submarine repeaters.
- 10) ROHM shall have no responsibility for any damages or injury arising from non-compliance with the recommended usage conditions and specifications contained herein.
- 11) ROHM has used reasonable care to ensure the accuracy of the information contained in this document. However, ROHM does not warrant that such information is error-free, and ROHM shall have no responsibility for any damages arising from any inaccuracy or misprint of such information.
- 12) Please use the Products in accordance with any applicable environmental laws and regulations, such as the RoHS Directive. For more details, including RoHS compatibility, please contact a ROHM sales office. ROHM shall have no responsibility for any damages or losses resulting from non-compliance with any applicable laws or regulations.
- 13) When providing our Products and technologies contained in this document to other countries, you must abide by the procedures and provisions stipulated in all applicable export laws and regulations, including without limitation the US Export Administration Regulations and the Foreign Exchange and Foreign Trade Act.
- 14) This document, in part or in whole, may not be reprinted or reproduced without prior consent of ROHM.



Thank you for your accessing to ROHM product informations.
More detail product informations and catalogs are available, please contact us.

ROHM Customer Support System

<http://www.rohm.com/contact/>