



ATTENTION
OBSERVE PRECAUTIONS
FOR HANDLING
ELECTROSTATIC
DISCHARGE
SENSITIVE
DEVICES

Part Number: WP154A4SUREQBFZGC

Hyper Red
Blue
Green

Features

- Uniform light output.
- Low power consumption.
- Long life-solid state reliability.
- RoHS compliant.

Description

The Hyper Red source color devices are made with Al-GaN on GaAs substrate Light Emitting Diode.

The Blue source color devices are made with InGaN Light Emitting Diode.

The Green source color devices are made with InGaN on Sapphire Light Emitting Diode.

Static electricity and surge damage the LEDs.

It is recommended to use a wrist band or anti-electrostatic glove when handling the LEDs.

All devices, equipment and machinery must be electrically grounded.

Package Dimensions

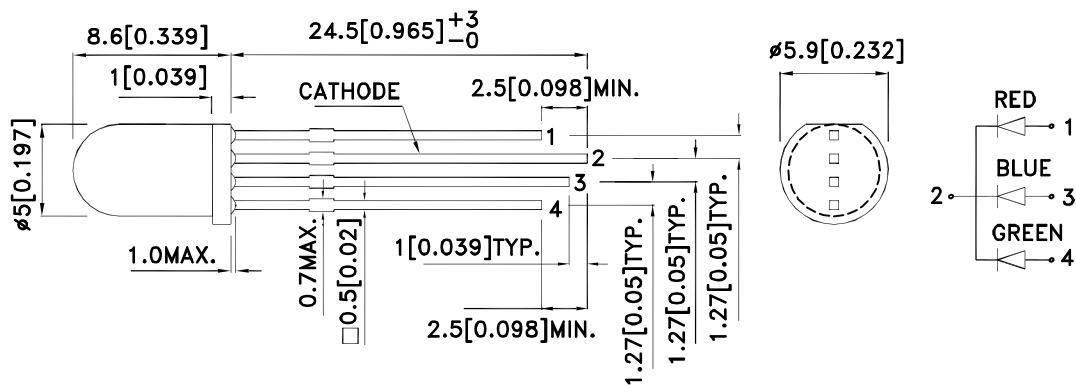

Notes:

1. All dimensions are in millimeters (inches).
2. Tolerance is $\pm 0.25 (0.01)$ unless otherwise noted.
3. Lead spacing is measured where the leads emerge from the package.
4. The specifications, characteristics and technical data described in the datasheet are subject to change without prior notice.



Selection Guide

Part No.	Dice	Lens Type	Iv (mcd) [2] @ 20mA		Viewing Angle [1]
			Min.	Typ.	2θ1/2
WP154A4SUREQBFZGC	Hyper Red (AlGaInP)	Water Clear	650	1300	50°
	Blue (InGaN)		500	1100	
	Green (InGaN)		1000	1700	

Notes:

1. θ1/2 is the angle from optical centerline where the luminous intensity is 1/2 of the optical peak value.
2. Luminous intensity/ luminous Flux: +/-15%.

Electrical / Optical Characteristics at TA=25°C

Symbol	Parameter	Device	Typ.	Max.	Units	Test Conditions
λpeak	Peak Wavelength	Hyper Red Blue Green	640 461 515		nm	IF=20mA
λD [1]	Dominant Wavelength	Hyper Red Blue Green	630 465 525		nm	IF=20mA
Δλ1/2	Spectral Line Half-width	Hyper Red Blue Green	25 25 30		nm	IF=20mA
C	Capacitance	Hyper Red Blue Green	45 100 45		pF	VF=0V;f=1MHz
VF [2]	Forward Voltage	Hyper Red Blue Green	1.9 3.3 3.3	2.5 4 4.1	V	IF=20mA
IR	Reverse Current	Hyper Red Blue Green		10 50 50	uA	VR=5V

Notes:

1. Wavelength: +/-1nm.
2. Forward Voltage: +/-0.1V.

Absolute Maximum Ratings at TA=25°C

Parameter	Hyper Red	Blue	Green	Units
Power dissipation	75	120	102.5	mW
DC Forward Current	30	30	25	mA
Peak Forward Current [1]	200	150	150	mA
Reverse Voltage	5			V
Operating/Storage Temperature	-40°C To +85°C			
Lead Solder Temperature [2]	260°C For 3 Seconds			
Lead Solder Temperature [3]	260°C For 5 Seconds			

Notes:

1. 1/10 Duty Cycle, 0.1ms Pulse Width.
2. 2mm below package base.
3. 5mm below package base.

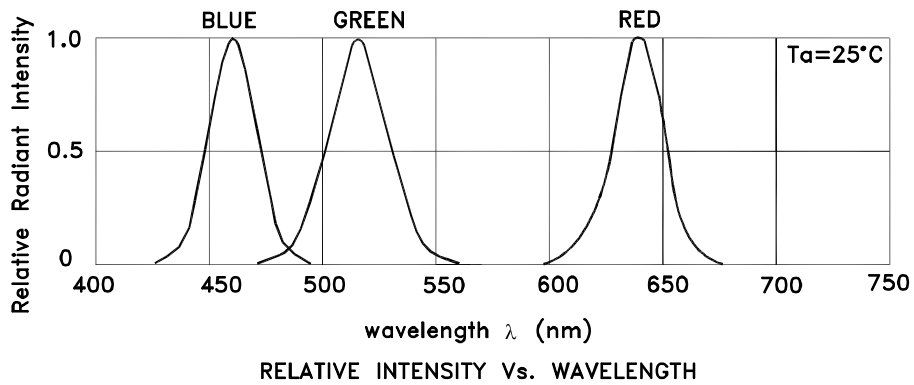

WP154A4SUREQBZGC Hyper Red

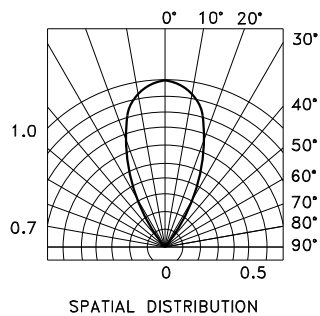
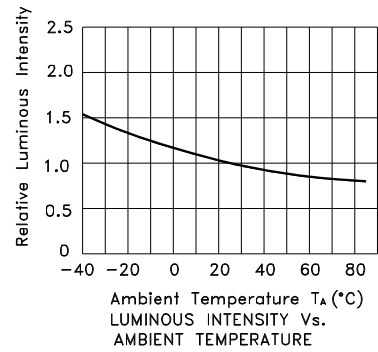
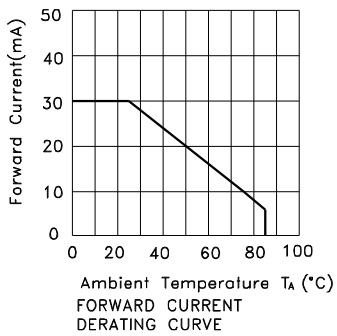
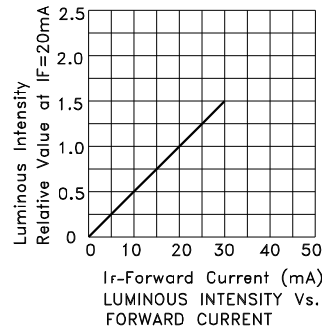
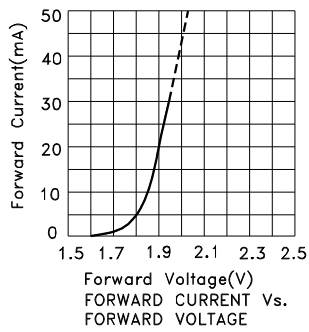

Kingbright

Blue

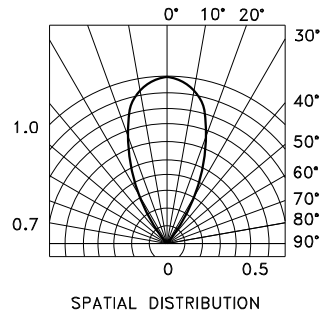
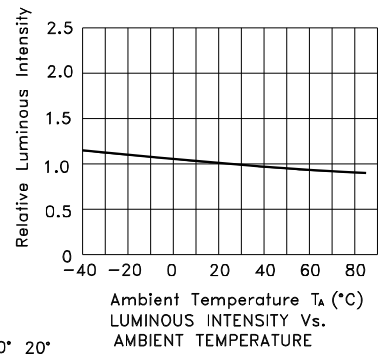
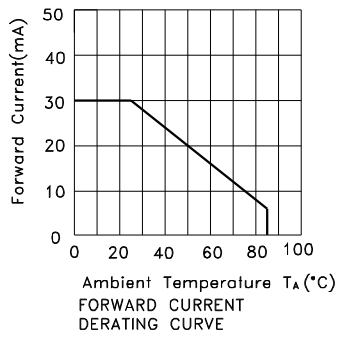
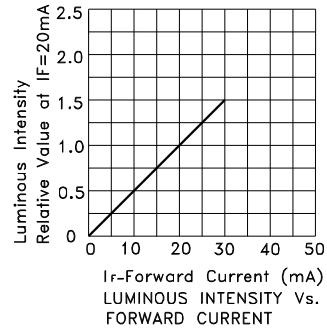
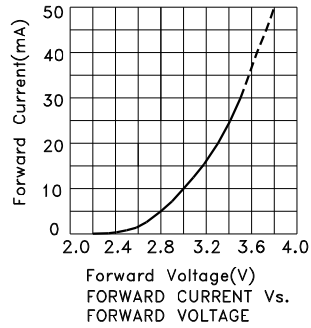

Green

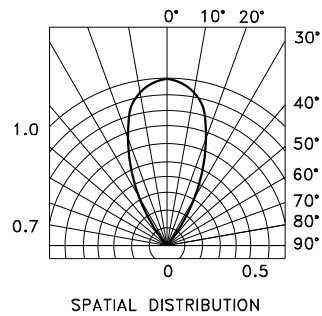
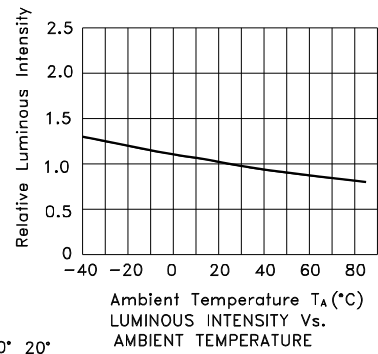
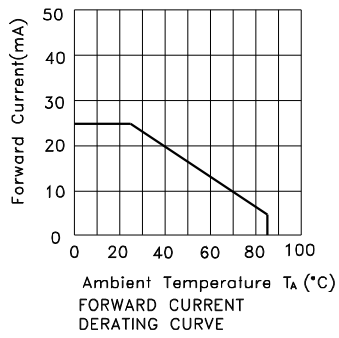
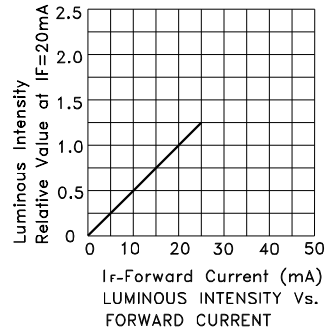
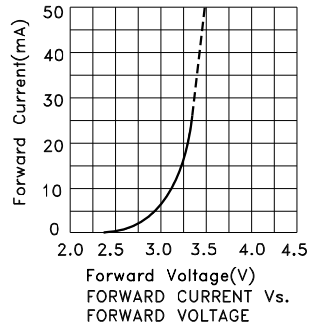

PACKING & LABEL SPECIFICATIONS

WP154A4SUREQBFZGC

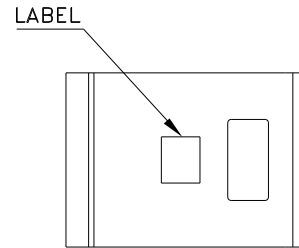
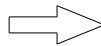
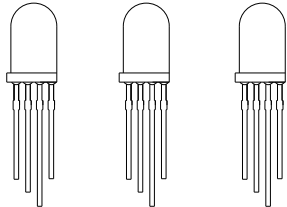

500 PCS / BAG



20K / 9# BOX

OUTSIDE LABEL

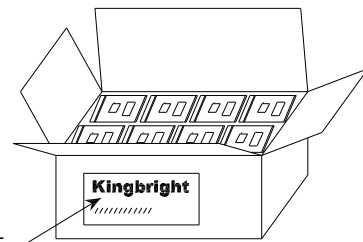
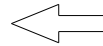

10K / 5# BOX

OUTSIDE LABEL

<h1>Kingbright</h1>	
P/NO: WP154A4xxx	
QTY: 500 pcs	Q.C. Q C XX XX XXXX PASSED
S/N: XXXX	
CODE: XXX	
LOT NO:	
 xxxxxxxxxxxxxxxxxxxxxxxxxxxx	
RoHS Compliant	

PRECAUTIONS

1. The lead pitch of the LED must match the pitch of the mounting holes on the PCB during component placement. Lead-forming may be required to insure the lead pitch matches the hole pitch. Refer to the figure below for proper lead forming procedures. (Fig. 1)

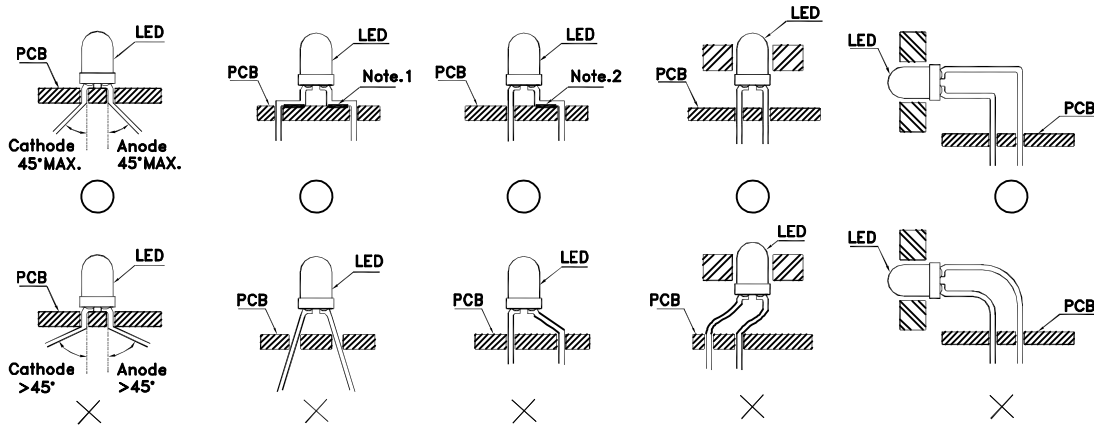

Fig.1

”○” Correct mounting method ”×” Incorrect mounting method

2. When soldering wire to the LED, use individual heat-shrink tubing to insulate the exposed leads to prevent accidental contact short-circuit. (Fig.2)

3. Use stand-offs (Fig.3) or spacers (Fig.4) to securely position the LED above the PCB.

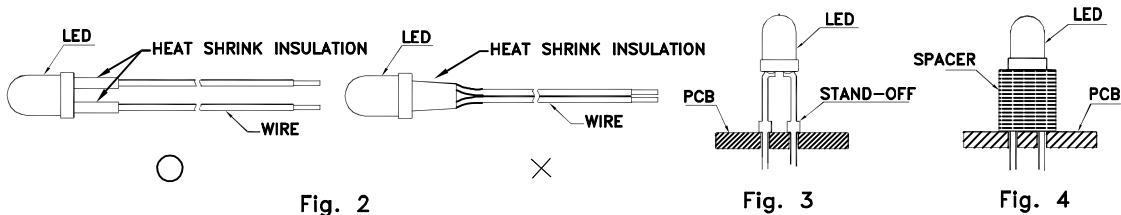

Fig. 2

Fig. 3

Fig. 4

4. Maintain a minimum of 2mm clearance between the base of the LED lens and the first lead bend. (Fig. 5 and 6)
5. During lead forming, use tools or jigs to hold the leads securely so that the bending force will not be transmitted to the LED lens and its internal structures. Do not perform lead forming once the component has been mounted onto the PCB. (Fig. 7)

6. Do not bend the leads more than twice. (Fig. 8)

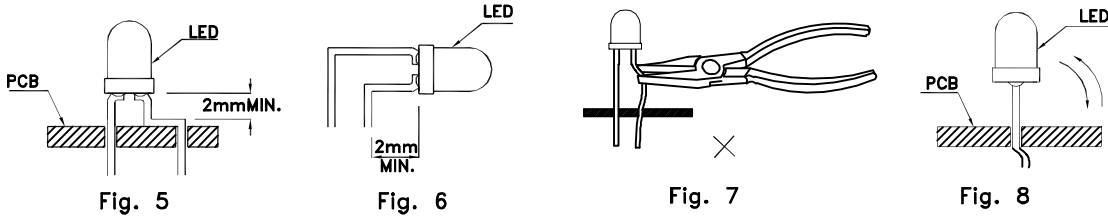

7. During soldering, component covers and holders should leave clearance to avoid placing damaging stress on the LED during soldering.

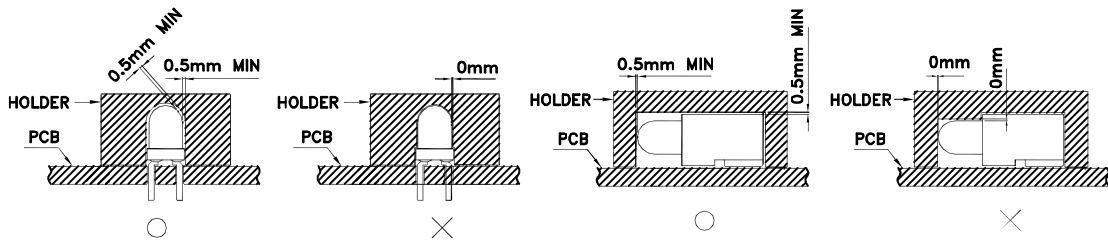

8. The tip of the soldering iron should never touch the lens epoxy.

9. Through-hole LEDs are incompatible with reflow soldering.

10. If the LED will undergo multiple soldering passes or face other processes where the part may be subjected to intense heat, please check with Kingbright for compatibility.

11. Recommended Wave Soldering Profile for Kingbright Thru-Hole Products

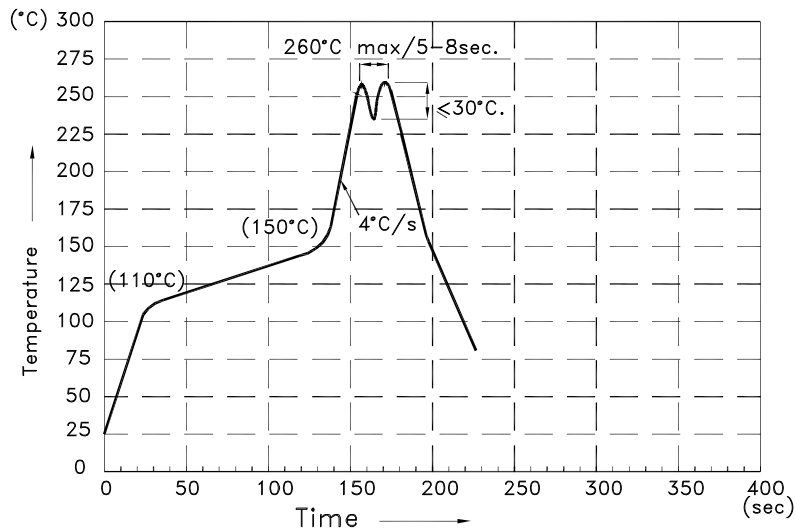

NOTES:

1. Recommend the wave temperature 245°C~260°C. The maximum soldering temperature should be less than 260°C.
2. Do not apply stress on epoxy resins when temperature is over 85°C.
3. The soldering profile apply to the lead free soldering (Sn/Cu/Ag alloy).
4. During wave soldering, the PCB top-surface temperature should be kept below 105°C.
5. No more than once.